

TABLE OF CONTENTS

SECTION

PAGE

1	INTRODUCTION	3	1
2	THINGS TO KNOW BEFORE STARTING YOUR VEHICLE	11	2
3	UNDERSTANDING THE FEATURES OF YOUR VEHICLE	73	3
4	UNDERSTANDING YOUR INSTRUMENT PANEL	181	4
5	STARTING AND OPERATING	273	5
6	WHAT TO DO IN EMERGENCIES	365	6
7	MAINTAINING YOUR VEHICLE	379	7
8	MAINTENANCE SCHEDULES	439	8
9	IF YOU NEED CONSUMER ASSISTANCE	447	9
10	INDEX	457	10

INTRODUCTION

CONTENTS

■ Introduction	4	■ Warnings And Cautions	8
■ Rollover Warning	5	■ Vehicle Identification Number	8
■ How To Use This Manual	6	■ Vehicle Modifications/Alterations	9

INTRODUCTION

This is a specialized utility vehicle designed for both on-road and off-road use. It can go places and perform tasks for which conventional two-wheel drive vehicles were not intended. However, on-road ride and handling will have a different feel from what drivers experience with other vehicles, so take time to become familiar with your vehicle.

The two-wheel drive utility vehicle was designed for on-road use only. It is not intended for off-road driving or use in other severe conditions suited for a four-wheel drive vehicle.

Before you start to drive this vehicle, read this manual. Be sure you are familiar with all vehicle controls, particularly those used for braking, steering and transmission and transfer case shifting. Learn how your vehicle handles on different road surfaces. Your driving skills will improve with experience. When driving off-road or

working the vehicle, don't overload it or expect it to overcome the laws of nature. Always observe federal, state, provincial, and local laws wherever you drive.

As with other vehicles of this type, failure to operate this vehicle correctly may result in loss of control or an accident. Be sure to read "On-Road/Off-Road Driving Tips" in Section 5 of this manual.

This manual has been prepared with the assistance of service and engineering specialists to acquaint you with the operation and maintenance of your new vehicle. It is supplemented by a Warranty Information Booklet and various customer oriented documents. You are urged to read these publications carefully. Following the instructions and recommendations in this manual will help assure safe and enjoyable operation of your vehicle.

NOTE: After you read the manual, it should be stored in the vehicle for convenient reference and remain with the vehicle when sold so that the new owner will be aware of all safety warnings.

When it comes to service, remember that your authorized dealer knows your vehicle best, has the factory-trained technicians and genuine Mopar® parts, and is interested in your satisfaction.

ROLLOVER WARNING

Utility vehicles have a significantly higher rollover rate than other types of vehicles. This vehicle has a higher ground clearance, and a higher center of gravity than many passenger cars. It is capable of performing better in a wide variety of off-road applications. Driven in an unsafe manner, all vehicles can be caused to go out of control. Because of the higher center of gravity, if this vehicle is out of control it may rollover when some other vehicles may not.

Do not attempt sharp turns or abrupt maneuvers or other unsafe driving actions that can cause loss of vehicle control. Failure to operate this vehicle safely may result in an accident, rollover of the vehicle, and severe or fatal injury. Drive carefully.

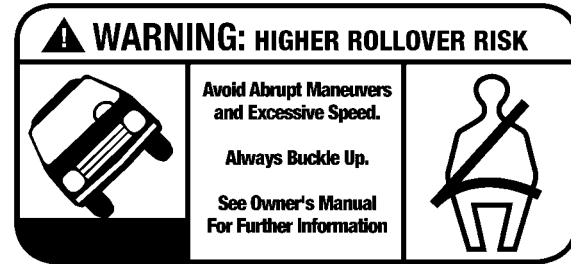

80bfe0f0

Rollover Warning Label



































































Failure to use driver and passenger seat belts provided is a major cause of severe or fatal injury. In fact, the U.S. government notes that the universal use of existing seat belts could cut the highway death toll by 10,000 or more each year, and could reduce disabling injuries by 2 million annually. In a rollover crash, an unbelted person is significantly more likely to die than a person wearing a seat belt. Always buckle up.

HOW TO USE THIS MANUAL

Consult the table of contents to determine which section contains the information you desire.

The detailed index, at the rear of this manual, contains a complete listing of all subjects.

Consult the following table for a description of the symbols that may be used on your vehicle or throughout this owner manual:

											ESP BAS ELECTRONIC STABILITY PROGRAM / BRAKE ASSIST SYSTEM
											BRAKE BRAKE SYSTEM WARNING PARKING BRAKE
										AWD!	 FAILURE OF ANTI-LOCK BRAKING SYSTEM
										4WD!	BRAKE BRAKE SYSTEM WARNING PARKING BRAKE
											TOW/HAUL TOW / HAUL
											4 LOW FOUR WHEEL DRIVE LOW
			SRS AIRBAG SUPPLEMENTAL RESTRAINT SYSTEM								8191e970

WARNINGS AND CAUTIONS

This manual contains **WARNINGS** against operating procedures, which could result in an accident or bodily injury. It also contains **CAUTIONS** against procedures, which could result in damage to your vehicle. If you do not read this entire manual, you may miss important information. Observe all Warnings and Cautions.

VEHICLE IDENTIFICATION NUMBER

The vehicle identification number (VIN) is found on a label located on the left front corner of the instrument panel pad, visible from outside of the vehicle through the windshield. This number also appears on the Automobile Information Disclosure Label affixed to a window on your vehicle. Save this label for a convenient record of your vehicle identification number and optional equipment.

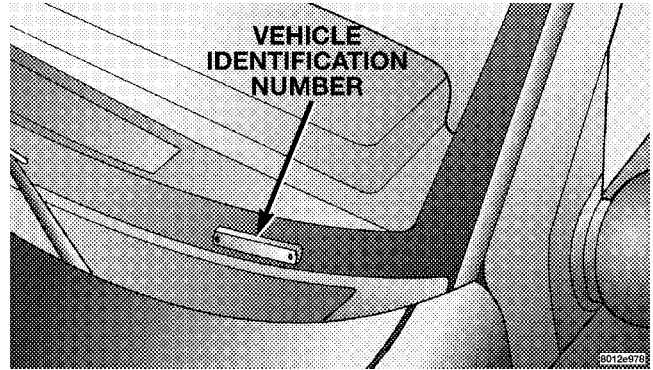

NOTE: It is illegal to remove the VIN label.

VEHICLE MODIFICATIONS/ALTERATIONS**WARNING!**

Any modifications or alterations to this vehicle could seriously affect its roadworthiness and safety and may lead to an accident resulting in serious injury or death.

THINGS TO KNOW BEFORE STARTING YOUR VEHICLE

CONTENTS

■ A Word About Your Keys14	■ Security Alarm System — If Equipped20
□ Wireless Ignition Node (WIN)14	□ To Set The Alarm20
□ FOB With Integrated Key (FOBIK)15	□ To Disarm The System21
□ Ignition Key Removal16	■ Illuminated Entry21
□ Key-In-Ignition Reminder17	■ Remote Keyless Entry21
■ Sentry Key17	□ To Unlock The Doors22
□ Replacement Keys18	□ To Lock The Doors23
□ Customer Key (FOB) Programming19	□ To Release The Liftgate Flipper Glass24
□ General Information20	□ Using The Panic Alarm24

12 THINGS TO KNOW BEFORE STARTING YOUR VEHICLE

□ Programming Additional Transmitters25	□ Power Liftgate — If Equipped36
□ Transmitter Battery Service25	■ Occupant Restraints38
□ General Information26	□ Lap/Shoulder Belts39
■ Remote Starting System — If Equipped26	□ Lap/Shoulder Belt Operating Instructions40
■ Door Locks28	□ Adjustable Upper Shoulder Belt Anchorage44
□ Manual Door Locks28	□ Automatic Locking Mode — If Equipped44
□ Power Door Locks29	□ Energy Management Feature45
□ Child Protection Door Lock30	□ Seat Belt Pretensioners46
■ Windows31	□ Enhanced Seat Belt Use Reminder System (BeltAlert)46
□ Power Windows31	□ Seat Belts And Pregnant Women47
□ Wind Buffeting33	□ Seat Belt Extender48
■ Liftgate34	□ Driver And Front Passenger Supplemental Restraint Systems (SRS)48
□ Liftgate Flipper Glass35		

THINGS TO KNOW BEFORE STARTING YOUR VEHICLE 13

<input type="checkbox"/> Child Restraint60	<input type="checkbox"/> Safety Checks You Should Make Inside The Vehicle71
<input checked="" type="checkbox"/> Engine Break-In Recommendations69	<input type="checkbox"/> Safety Checks You Should Make Outside The Vehicle72
<input checked="" type="checkbox"/> Safety Tips70		
<input type="checkbox"/> Exhaust Gas70		

A WORD ABOUT YOUR KEYS

Your vehicle uses a keyless ignition system. This system consists of a Fob with Integrated Key and a Wireless Ignition Node (WIN) with integral ignition switch. You can insert the double-sided integrated key into the ignition switch with either side up.

Wireless Ignition Node (WIN)

The Wireless Ignition Node (WIN) operates similar to an ignition switch. It has four operating positions, three of which are detented and one spring-loaded. The detented positions are LOCK, ACC, and ON. The START position is a spring-loaded momentary contact position. When released from the START position, the switch automatically returns to the detented ON position.

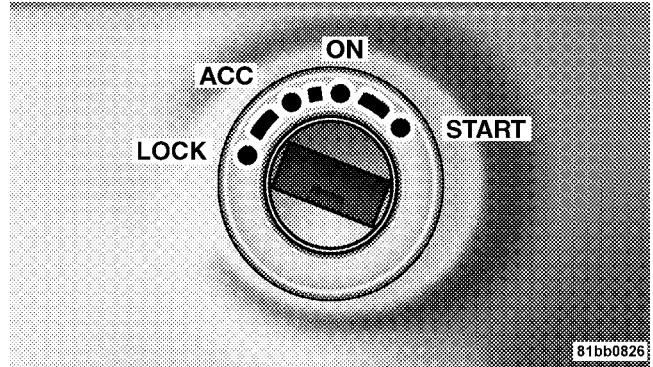

Wireless Ignition Node (WIN)

Fob with Integrated Key (FOBIK)

The Fob with Integrated Key operates the ignition switch. It also contains the Remote Keyless Entry (RKE) transmitter and a valet key, which stores in the rear of the Fob.

The valet key allows for entry into the vehicle should the battery in the vehicle or the Fob go dead. You can keep the valet key with you when valet parking.

To remove the valet key from the Fob, slide the mechanical latch at the top of the Fob sideways with your thumb and then pull the key out of the Fob with your other hand.

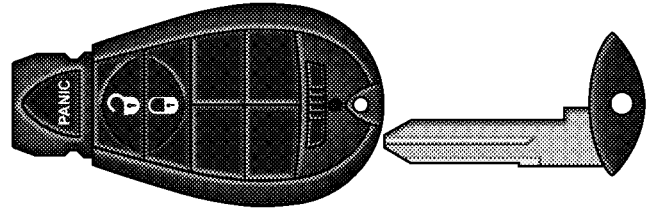

81bb182d

3 Button FOBIK

NOTE: You can insert the double-sided valet key into the lock cylinders with either side up.

Ignition Key Removal

Place the selector lever in “P” (Park). Turn the key to the LOCK position, and remove the key.

NOTE:

- If you try to remove the key before you place the selector lever in “P” (Park), it may become trapped temporarily in the ignition switch. If this occurs, rotate the key to the right slightly, then remove the key as described. If a malfunction occurs, the system will trap the key in the ignition switch to warn you that this safety feature is inoperable. The engine can be started and stopped, but the key cannot be removed until you obtain service.
- For vehicles equipped with the Electronic Vehicle Information Center (EVIC), the power window switches, radio, power sunroof (if equipped), and power outlets will remain active for up to 60 minutes

after the ignition switch is turned to the LOCK position. Opening either front door will cancel this feature. The time for this feature is programmable. For details, refer to “Delay Power Off to Accessories Until Exit,” under “Personal Settings (Customer Programmable Features),” under “Electronic Vehicle Information Center (EVIC)” in Section 4 of this manual.

WARNING!

Never leave children alone in a vehicle. Leaving children in a vehicle unattended is dangerous for a number of reasons. A child or others could be seriously or fatally injured. Don't leave the keys in the ignition. A child could operate power windows, other controls, or move the vehicle.

CAUTION!

An unlocked car is an invitation to thieves. Always remove key from the ignition and lock all doors when leaving the vehicle unattended.

Key-In-Ignition Reminder

If you open the driver's door and the key is in the ignition, a chime will sound to remind you to remove the key.

NOTE: The Key-In-Ignition reminder only sounds when the ignition key is placed in the LOCK or ACC position.

SENTRY KEY

The Sentry Key Immobilizer System prevents unauthorized vehicle operation by disabling the engine. The system does not need to be armed or activated. Operation is automatic, regardless of whether the vehicle is locked or unlocked.

The system uses the factory-mated Fob with Integrated Key and Wireless Ignition Node (WIN) to prevent unauthorized vehicle operation. Therefore, only Fobs that are programmed to the vehicle can be used to start and operate the vehicle. The system will shut the engine off in two (2) seconds if someone uses an invalid Fob to start the engine.

After turning the ignition switch to the ON position, the Vehicle Security Alarm Indicator Light will turn on for three (3) seconds for a bulb check. If the light remains on after the bulb check, it indicates that there is a problem with the electronics. In addition, if the light begins to

18 THINGS TO KNOW BEFORE STARTING YOUR VEHICLE

flash after the bulb check, it indicates that someone used an invalid Fob to start the engine. Either of these conditions will result in the engine being shut off after two (2) seconds.

If the Vehicle Security Alarm Indicator Light turns on during normal vehicle operation (vehicle running for longer than 10 seconds), it indicates that there is a fault in the electronics. Should this occur, have the vehicle serviced as soon as possible.

NOTE:

- The Sentry Key Immobilizer System is not compatible with aftermarket remote starting systems. Use of these systems may result in vehicle starting problems and loss of security protection.
- Exxon/Mobil Speed Pass,TM additional Fobs, or any other transponder-equipped components on the same key chain will **not** cause a fault unless the additional part is **physically held against the Fob** being used to

start the vehicle. Cell phones, pagers, or other RF electronics will not cause interference with this system.

All of the Fobs provided with your new vehicle have been programmed to the vehicle electronics.

Replacement Keys

NOTE: Only Fobs that are programmed to the vehicle electronics can be used to start and operate the vehicle. Once a Fob is programmed to a vehicle, it cannot be programmed to any other vehicle.

CAUTION!

Always remove Sentry Keys from the vehicle and lock all doors when leaving the vehicle unattended.

At the time of purchase, the original owner is provided with a four-digit PIN number. Keep the PIN in a secure

location. This number is required for dealer replacement of Fobs. Duplication of Fobs may be performed at an authorized dealer or by using the Customer Key Programming procedure. This procedure consists of programming a blank Fob to the vehicle electronics. A blank Fob is one, which has never been programmed.

NOTE: When having the Sentry Key Immobilizer System serviced, bring all vehicle Fobs with you to the dealer.

Customer Key (Fob) Programming

If you have two valid sentry keys, you can program new sentry keys to the system by performing the following procedure:

1. Insert the first valid key into the ignition switch and turn the ignition switch ON for at least 3 seconds but no longer than 15 seconds. Turn the ignition switch OFF and remove the first key.

2. Insert the second valid key and turn the ignition switch ON within 15 seconds. After ten seconds, a chime will sound and the Vehicle Security Alarm Indicator Light will begin to flash. Turn the ignition switch OFF and remove the second key.

3. Insert a blank Sentry Key into the ignition switch and turn the ignition switch ON within 60 seconds. After 10 seconds, a single chime will sound and the Vehicle Security Alarm Indicator Light will stop flashing, turn on again for 3 seconds, and then turn off.

The new Sentry Key is programmed. **The Keyless Entry Transmitter will also be programmed during this procedure.**

Repeat this procedure to program up to 8 keys. If you do not have a programmed sentry key, contact your dealer for details.

NOTE: If a programmed key is lost, see your dealer to have all remaining keys erased from the systems memory. This will prevent the lost key from starting your vehicle. The remaining keys must then be reprogrammed. All vehicle keys must be taken to the dealer at the time of service to be reprogrammed.

General Information

The Sentry Key system complies with FCC rules part 15 and with RSS-210 of Industry Canada. Operation is subject to the following conditions:

- This device may not cause harmful interference.
- This device must accept any interference that may be received, including interference that may cause undesired operation.

SECURITY ALARM SYSTEM — IF EQUIPPED

This system monitors the vehicle doors, liftgate, liftgate flipper glass, and ignition for unauthorized operation and movement inside of the vehicle. When the alarm is activated, the system provides both audible and visual signals. The horn will sound repeatedly for three minutes and the headlights and taillights will flash for an additional 15 minutes.

To Set the Alarm

The alarm will set when you use the remote keyless entry transmitter to lock the doors and liftgate or when you use the power door lock switch while the door is open. After all the doors are locked and closed, a red light (located in the instrument cluster) will flash rapidly for about 16 seconds to signal that the system is arming. During this 16 second pre-arm period, opening any door or the liftgate will cancel the arming. If the system successfully arms, the red light will flash at a slower rate to indicate the alarm is set. A manual lock of the doors, either with

the door lock plunger located on the inside of the doors or with the driver's door key lock cylinder, will not set the alarm.

To Disarm the System

To disarm the system, use the remote keyless entry transmitter. If something has triggered the system in your absence, the horn will sound three times when you unlock the doors. Check the vehicle for tampering.

The Security Alarm System is designed to protect your vehicle; however, you can create conditions where the system will arm unexpectedly. If you remain in the vehicle and lock the doors with the transmitter, once the system is armed (after 16 seconds), when you pull the door handle to exit the alarm will sound. If this occurs, press the "Unlock" button on the remote keyless entry transmitter to disarm the system. The Security Alarm System will not disarm with a manual unlock, either

through the lock plunger located on the inside of the door, or through a key in the driver's door key cylinder.

ILLUMINATED ENTRY

The interior lights come on when you open any door. They will remain on for about 30 seconds after all doors are closed then fade to off.

The lights also will fade to off if you turn on the ignition after you close all the doors.

REMOTE KEYLESS ENTRY

This system allows you to lock or unlock the doors, liftgate, or activate the panic alarm from distances up to about 23 feet (7 meters) using a hand held radio transmitter. The transmitter need not be pointed at the vehicle to activate the system.

NOTE: Inserting the Fob with Integrated Key into the ignition switch disables all buttons on that transmitter; however, the buttons on the remaining transmitters will continue to work. Shifting the vehicle out of “P” (Park) disables all transmitter buttons for all Fobs.

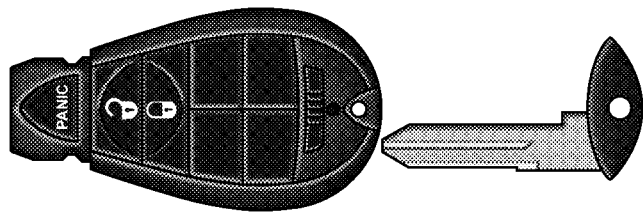

81bb182d

3 Button FOB

To Unlock the Doors

Press and release the UNLOCK button on the transmitter once to unlock the driver’s door, or twice to unlock all doors. The turn signal lights will flash to acknowledge the unlock signal. The illuminated entry system will also turn on.

Remote Key Unlock, Driver Door/All Doors First

This feature lets you program the system to unlock either the driver’s door or all doors on the first press of the UNLOCK button on the transmitter. To change the current setting, proceed as follows:

- For vehicles equipped with the Electronic Vehicle Information Center (EVIC), refer to “Remote Key Unlock,” under “Personal Settings (Customer Programmable Features),” under “Electronic Vehicle Information Center (EVIC)” in Section 4 of this manual for details.

Flash Lights with Remote Key Lock

This feature will cause the turn signal lights to flash when the doors are locked or unlocked with the transmitter. This feature can be turned on or off. To change the current setting, proceed as follows:

- For vehicles equipped with the Electronic Vehicle Information Center (EVIC), refer to “Flash Lights with Remote Key Lock,” under “Personal Settings (Customer Programmable Features),” under “Electronic Vehicle Information Center (EVIC)” in Section 4 of this manual for details.

Turn Headlights On with Remote Key Unlock

This feature activates the headlights for up to 90 seconds when the doors are unlocked with the transmitter. The time for this feature is programmable on vehicles equipped with the Electronic Vehicle Information Center (EVIC). For details, refer to “Turn Headlights On with

Remote Key Unlock,” under “Personal Settings (Customer Programmable Features),” under “Electronic Vehicle Information Center (EVIC)” in Section 4 of this manual.

To Lock the Doors

Press and release the LOCK button on the transmitter to lock all doors. The turn signal lights will flash and the horn will chirp to acknowledge the signal.

Sound Horn with Remote Key Lock

This feature will cause the horn to chirp when the doors are locked with the transmitter. This feature can be turned on or off. To change the current setting, proceed as follows:

- For vehicles equipped with the Electronic Vehicle Information Center (EVIC), refer to “Sound Horn with Remote Key Lock,” under “Personal Settings (Customer Programmable Features),” under “Electronic Vehicle Information Center (EVIC)” in Section 4 of this manual for details.

To Release the Liftgate Flipper Glass

Press the “Flipper Glass/Trunk Release” button on the transmitter two times to release the flipper glass.

WARNING!

Driving with the flipper glass open can allow poisonous exhaust gases into your vehicle. You and your passengers could be injured by these fumes. Keep the flipper glass closed when you are operating the vehicle.

Using The Panic Alarm

To turn the panic alarm feature ON or OFF, press and hold the PANIC button on the transmitter for at least one second and release. When the panic alarm is on, the headlights and park lights will flash, the horn will pulse on and off, and the interior lights will turn on.

The panic alarm will stay on for 3 minutes unless you turn it off by either pressing the PANIC button a second time or drive the vehicle at a speed of 15 mph (24 km/h) or greater.

NOTE:

- The interior lights will turn off if you turn the ignition switch to the ACC or ON position while the panic alarm is activated. However, the exterior lights and horn will remain on.
- You may need to be less than 23 feet (7 meters) from the vehicle when using the transmitter to turn off the panic alarm due to the radio frequency noises emitted by the system.

Programming Additional Transmitters

Refer to SENTRY KEY “Customer Key (Fob) Programming.”

If you do not have a programmed transmitter, contact your dealer for details.

Transmitter Battery Service

The recommended replacement battery is one CR2032 battery.

NOTE: Perchlorate Material — special handling may apply. See www.dtsc.ca.gov/hazardouswaste/perchlorate

NOTE: Do not touch the battery terminals that are on the back housing or the printed circuit board.

1. Battery access is through a door located on the rear of the FOBIK. Insert a small, flat bladed screwdriver into the slot and gently pry open the access door.

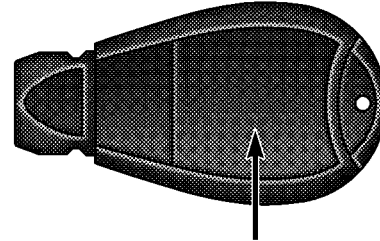

BATTERY ACCESS DOOR

81bb1827

FOBIK Battery Replacement

2. Remove and replace the batteries. Avoid touching the new batteries with your fingers. Skin oils may cause battery deterioration. If you touch a battery, clean it with rubbing alcohol.
3. Reposition the access door panel over the battery opening and snap into place.

General Information

This device complies with part 15 of the FCC rules and RSS 210 of Industry Canada. Operation is subject to the following conditions:

- This device may not cause harmful interference.
- This device must accept any interference received, including interference that may cause undesired operation.

NOTE: Changes or modifications not expressly approved by the party responsible for compliance could void the user's authority to operate the equipment.

If your Remote Keyless Entry (RKE) transmitter fails to operate from a normal distance, check for these two conditions.

1. A weak battery in the transmitter. The expected life of the battery is a minimum of three years.

2. Closeness to a radio transmitter such as a radio station tower, airport transmitter, and some mobile or CB radios.

REMOTE STARTING SYSTEM — IF EQUIPPED

Your vehicle may be equipped with a remote starting system, which will allow the vehicle to be started up to 300 feet (91 meters) away from the vehicle using the remote keyless entry key fob which is part of your ignition key.

In order to remote start your vehicle, the hood, liftgate, and all of the doors must be closed.

To remote start your vehicle, press the "Remote Start" button on the key fob twice within three seconds. To indicate that the vehicle is about to start, the parking lights will flash and the horn will sound briefly (if programmed). To turn the horn on or off, refer to "Electronic Vehicle Information Center/Customer Programmable Features/Sound Horn With Lock?" in Section 4 of this manual.

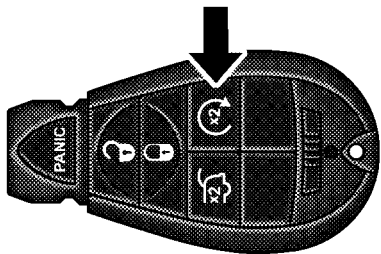

81c1c0a3

Remote Start Button

Once the vehicle has started, the engine will run for 15 minutes. To cancel remote start, press the “Remote Start” button once.

The parking lamps will remain illuminated to indicate that the vehicle has remote started and the engine is running. The lamps will turn off when the ignition is turned to RUN or the remote start is cancelled.

To enter the vehicle while the engine is running during a remote start, you must first unlock the vehicle using the “Unlock” button on the key fob. After the vehicle is unlocked, you have 15 minutes to enter the vehicle, insert the key into the ignition, and move it to the RUN position. Otherwise, the engine will cancel remote start and automatically turn off.

Remote start will also cancel if any of the following occur:

- If the engine stalls or RPM exceeds 2500
- Any engine warning lamps come on
- The hood is opened
- The hazard switch is pressed
- The transmission is moved out of P (Park).
- The brake pedal is pressed.

The vehicle can be started remotely up to a maximum of two times. The vehicle is also allowed a maximum of one failed start, where the remote start sequence was initiated but the engine stopped cranking without starting. After either of these conditions, or if the Vehicle Theft Alarm is alarming, or if the PANIC button was pressed, the vehicle must be reset by inserting a valid key into the ignition and moving it to the RUN position, then back to LOCK.

DOOR LOCKS

Manual Door Locks

Use the manual door lock plunger to lock the doors from inside the vehicle. If the plunger is down when the door is closed, the door will lock. Therefore, make sure the keys are not inside the vehicle before closing the door.

WARNING!

- **For personal security and safety in the event of an accident, lock the vehicle doors when you drive as well as when you park and leave the vehicle.**
- **When leaving the vehicle always remove the key from the ignition lock, and lock your vehicle. Do not leave children unattended in the vehicle, or with access to an unlocked vehicle. Unsupervised use of vehicle equipment may cause severe personal injuries and death.**

Power Door Locks

The power door lock switch is located on each front door panel. Press the switch to lock or unlock the doors.

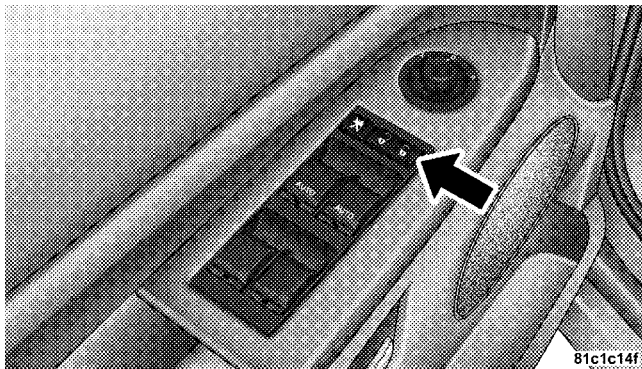

Power Door Lock Switch

If the plunger is down when the door is closed, the door will lock. Therefore, make sure the keys are not inside the vehicle before closing the door.

If you press the door lock switch while the keys are in the ignition switch, and the driver's door is open, the doors will not lock.

The rear doors cannot be opened from inside the vehicle until you pull up the lock plungers.

Automatic Door Locks

If this feature is selected your door locks will lock automatically if the vehicle speed is above 15 mph (24 km/h) and all doors are closed. It will reset whenever a door is opened.

This feature is selectable and can be turned on or off. Refer to “Electronic Vehicle Information Center (EVIC) — Customer Programmable Features” in Section 4 of this manual or see your authorized dealer.

Automatic Unlock on Exit Feature — Only Available if Auto Lock is Enabled

This feature will unlock all the doors when the driver's door is opened if the vehicle is stopped and in P (Park) or N (Neutral). Refer to “Electronic Vehicle Information Center (EVIC) — Customer Programmable Features” in Section 4 of this manual or see your authorized dealer.

Child Protection Door Lock

The rear doors of your vehicle are equipped with child protection locks. If you push up on the lever on the open edge of the door it cannot be opened from the inside of the vehicle. Push the lever down to disengage the child protection locks.

WARNING!

Avoid trapping anyone in the vehicle in a collision. Remember that the rear doors can only be opened from the outside when the child protection locks are engaged.

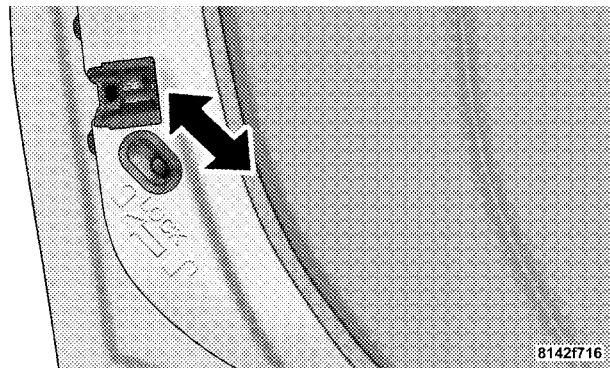

Child Protection Door Lock

WINDOWS

Power Windows

The power window controls are located on the driver's door trim panel. There is a single switch on the front passenger door/rear doors which operates the front passenger/rear passenger door windows. The window controls will operate only when the ignition switch is in the ON or ACCESSORY position.

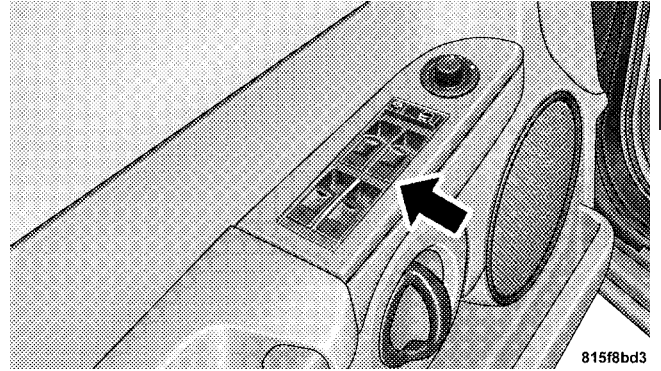

2

Power Window Switches

The power window switches remain active for up to 10 minutes after the ignition switch has been turned off. Opening a vehicle front door will cancel this feature.

Auto Down

Both the driver and front passenger window switch has an “Auto Down” feature. Press the window switch past the first detent, release, and the window will go down automatically. To cancel the “Auto Down” movement, operate the switch in either the up or down direction and release the switch.

To stop the window from going all the way down during the auto-down operation, pull up on the switch briefly.

To open the window part way, press to the first detent and release it when you want the window to stop.

The power window switches remain active for 10 minutes after the ignition has been turned off. Opening either front door will cancel this feature.

Auto Up Feature with Anti-Pinch Protection (Driver’s and Front Passenger Door Only)

Lift the window switch to the second detent, release, and the window will go up automatically.

To stop the window from going all the way up during the auto-up operation, push down on the switch briefly.

To close the window part way, lift the window switch to the first detent and release when you want the window to stop.

NOTE: If the window runs into any obstacle during the auto-closure it will reverse direction and then stop. Remove the obstacle and use the window switch again to close the window. Any impact due to rough road conditions may trigger the auto reverse function unexpectedly during auto closure. If this happens pull the switch lightly to the first detent and hold to close the window manually.

WARNING!

There is no anti-pinch protection when the window is almost closed. Be sure to clear all objects from the window before closing.

Resetting the Auto-Up Feature

Should the Auto-Up feature stop working the window probably needs to be reset. To reset Auto-Up:

Pull the window switch up and close the window completely, then pull and hold the switch for 1 second.

Window Lockout Switch

The window lockout switch on the driver's door allows you to disable the window control on the other doors. To disable the window controls on the other doors, press the window lockout button. To enable the window controls, press the window lockout button again.

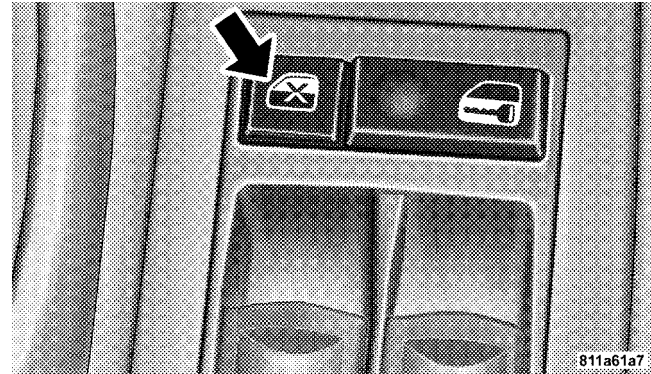
**Power Window Lock****Wind Buffeting**

Wind buffeting can be described as the perception of pressure on the ears or a helicopter type sound in the ears. Your vehicle may exhibit wind buffeting with the windows down, or the sunroof (if equipped) in certain

34 THINGS TO KNOW BEFORE STARTING YOUR VEHICLE

open or partially open positions. This is a normal occurrence and can be minimized. If the buffeting occurs with the sunroof open, adjust the sunroof opening to minimize the buffeting.

LIFTGATE

To open the liftgate, pull up (squeeze) on the handle and lift. Manually unlocking the vehicle doors with the plunger or a key in the lock cylinder will not unlock the liftgate.

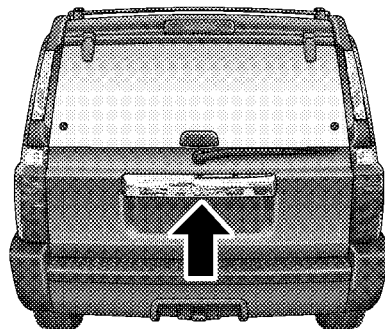

81605ae2

Liftgate Release

WARNING!

Driving with the liftgate open can allow poisonous exhaust gases into your vehicle. You and your passengers could be injured by these fumes. Keep the liftgate closed when you are operating the vehicle.

Liftgate Flipper Glass

The liftgate flipper glass is also unlocked when the liftgate is unlocked. To open the flipper glass, push up on the window switch located on the liftgate.

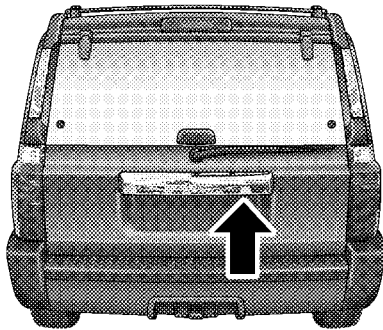

Liftgate Glass Release

81605ae9

WARNING!

To avoid injury stand back when opening. Glass will automatically rise.

2

Once the liftgate flipper glass has been opened, connection to the rear window wiper is interrupted, preventing activation of the rear wiper blade while the flipper glass is open.

WARNING!

Driving with the flipper glass open can allow poisonous exhaust gases into your vehicle. You and your passengers could be injured by these fumes. Keep the flipper glass closed when you are operating the vehicle.

Power Liftgate — If Equipped

The power liftgate may be opened manually or by using the button on the remote keyless entry transmitter. Press the button on the remote keyless entry transmitter twice within five seconds, to open the power liftgate. Once the liftgate is fully open, pressing the button twice within five seconds a second time will close the liftgate.

Also, the power liftgate may be closed by pressing a button located in the upper left trim, in the liftgate opening. Pressing once will close the liftgate only. This button cannot be used to open the liftgate.

When the remote keyless entry transmitter button is pressed two times and the “Lamp Flash” feature is enabled, the turn signals will flash twice to signal that the liftgate is opening or closing.

NOTE:

- In the event of a power malfunction to the liftgate, an emergency liftgate latch release can be used to open the liftgate. The emergency liftgate latch release can be accessed through a snap-in cover located on the liftgate trim panel.

WARNING!

During power operation, personal injury or cargo damage may occur. Ensure the liftgate travel path is clear. Make sure the liftgate is closed and latched before driving away.

A beeping signal will sound two seconds before the liftgate starts to open or close.

NOTE:

- If anything obstructs the power liftgate while it is closing or opening, the liftgate will automatically reverse to the closed or open position, provided it meets sufficient resistance.
- There are also pinch sensors attached to the side of the liftgate. Light pressure anywhere along these strips will cause the liftgate to return to the open position.
- The power liftgate must be in the full open position for any of the buttons to operate. If the liftgate is not fully open, press the remote keyless entry transmitter to fully open the liftgate and then press again to close.
- If the liftgate handle is pulled while the power liftgate is closing, the liftgate will reverse to the full open position.
- If the liftgate handle is pulled while the power liftgate is opening, the liftgate motor will disengage to allow manual operation.
- The power liftgate buttons will not operate if the vehicle is in gear or the vehicle speed is above 0 mph (0 km/h).
- The power liftgate will not operate in temperatures below -22°F (-30°C) or temperatures above 150°F (65°C). Be sure to remove any buildup of snow or ice from the liftgate before pressing any of the power liftgate switches.
- If the power liftgate encounters multiple obstructions within the same cycle, the system will automatically stop and must be opened or closed manually.
- If your liftgate is power closing and you put the vehicle in gear, the liftgate will continue to power close. However, vehicle movement may result in a detection of an obstruction.

WARNING!

- **Driving with the liftgate open can allow poisonous exhaust gases into your vehicle. You and your passengers could be injured by these fumes. Keep the liftgate closed when you are operating the vehicle.**
- **If you are required to drive with the liftgate open, make sure that all windows are closed, and the climate control blower switch is set at high speed. DO NOT use the recirculation mode.**

Gas props support the liftgate in the open position. However, because the gas pressure drops with temperature, it may be necessary to assist the props when opening the liftgate in cold weather.

OCCUPANT RESTRAINTS

Some of the most important safety features in your vehicle are the restraint systems. These include the front and rear seat belts for the driver and all passengers, front airbags for both the driver and right front passenger, and, window bags for the driver and passengers seated next to a window. If you will be carrying children too small for adult-size belts, your seat belts also can be used to hold infant and child restraint systems.

NOTE: The front airbags have a multi stage inflator design. This allows the airbag to have different rates of inflation that are based on collision severity.

Please pay close attention to the information in this section. It tells you how to use your restraint system properly to keep you and your passengers as safe as possible.

WARNING!

In a collision, you and your passengers can suffer injuries, including fatalities, if you are not properly buckled up. You can strike the interior of your vehicle or other passengers, or you can be thrown out of the vehicle. Always be sure you and others in your vehicle are buckled up properly.

Buckle up even though you are an excellent driver, even on short trips. Someone on the road may be a poor driver and cause a collision which includes you. This can happen far away from home or on your own street.

Research has shown that seat belts save lives, and they can reduce the seriousness of injuries in a collision. Some of the worst injuries happen when people are thrown from the vehicle. Seat belts reduce the possibility of ejection and the risk of injury caused by striking the inside of the vehicle. **Everyone** in a motor vehicle should be belted at all times to reduce or prevent injuries.

Lap/Shoulder Belts

All seating positions in your vehicle have combination lap/shoulder belts. The belt webbing retractor is designed to lock during very sudden stops or collisions. This feature allows the shoulder part of the belt to move freely with you under normal conditions. But in a collision, the belt will lock and reduce the risk of you striking the inside of the vehicle or being thrown out.

WARNING!

- **Wearing a seat belt incorrectly is dangerous. Seat belts are designed to go around the large bones of your body. These are the strongest parts of your body and can take the forces of a collision the best. Wearing your belt in the wrong place could make your injuries in a collision much worse. You might suffer internal injuries, or you could even slide out of part of the belt. Follow these instructions to wear your seat belt safely and to keep your passengers safe, too.**
- **Two people should never be belted into a single seat belt. People belted together can crash into one another in an accident, hurting one another badly. Never use a lap/shoulder belt or a lap belt for more than one person, no matter what their size.**

Lap/Shoulder Belt Operating Instructions

1. Enter the vehicle and close the door. Sit back and adjust the seat.
2. The seat belt latch plate is above the back of your seat. Grasp the latch plate and pull out the belt. Slide the latch plate up the webbing as far as necessary to make the belt go around your lap.

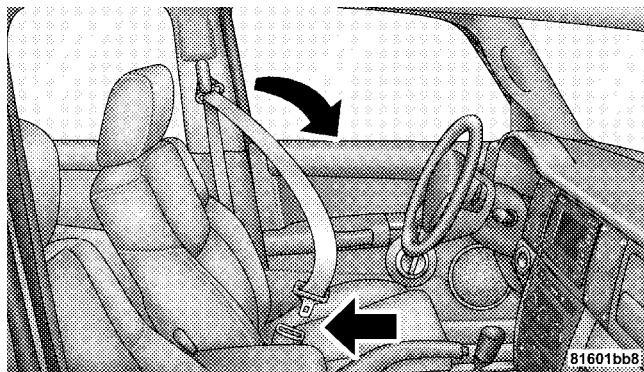

Latch Plate

3. When the belt is long enough to fit, insert the latch plate into the buckle until you hear a “click.”

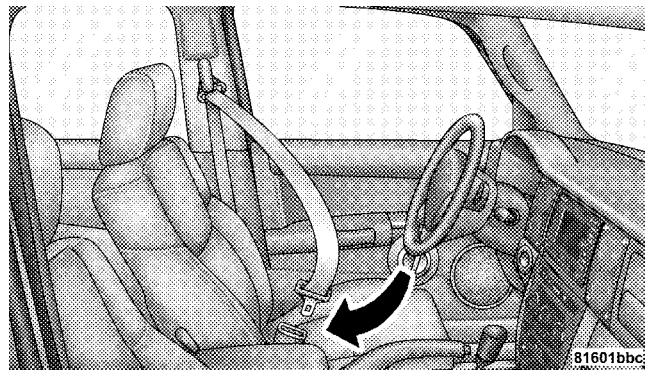

Latch Plate To Buckle

WARNING!

A belt that is buckled into the wrong buckle will not protect you properly. The lap portion could ride too high on your body, possibly causing internal injuries. Always buckle your belt into the buckle nearest you.

A belt that is too loose will not protect you as well. In a sudden stop you could move too far forward, increasing the possibility of injury. Wear your seat belt snugly.

A belt that is worn under your arm is very dangerous. Your body could strike the inside surfaces of the vehicle in a collision, increasing head and neck injury. A belt worn under the arm can cause internal injuries. Ribs aren't as strong as shoulder bones. Wear the belt over your shoulder so that your strongest bones will take the force in a collision.

A shoulder belt placed behind will not protect you from injury during a collision. You are more likely to hit your head in a collision if you do not wear your shoulder belt. The lap and shoulder belt are meant to be used together.

4. Position the lap belt across your thighs, below your abdomen. To remove slack in the lap portion, pull up a bit on the shoulder belt. To loosen the lap belt if it is too tight, tilt the latch plate and pull on the lap belt. A snug belt reduces the risk of sliding under the belt in a collision.

WARNING!

A lap belt worn too high can increase the risk of injury in a collision. The belt forces won't be at the strong hip and pelvic bones, but across your abdomen. Always wear the lap part of your seat belt as low as possible and keep it snug.

A twisted belt can't do its job as well. In a collision it could even cut into you. Be sure the belt is straight. If you can't straighten a belt in your vehicle, take it to your authorized dealer and have it fixed.

5. Position the shoulder belt on your chest so that it is comfortable and not resting on your neck. The retractor will withdraw any slack in the belt.

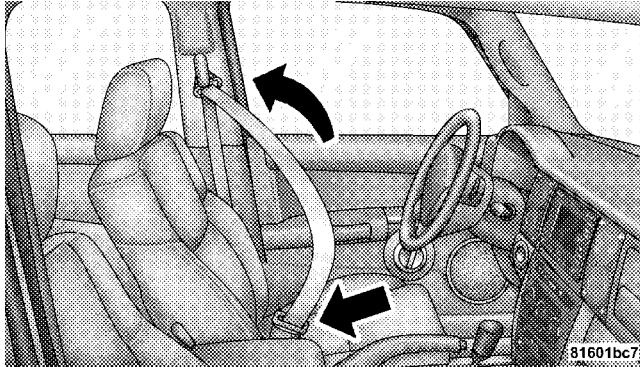

Removing Slack From Belt

6. To release the belt, push the red button marked PRESS on the buckle. The belt will automatically retract to its stowed position. If necessary, slide the latch plate down the webbing to allow it to retract fully.

2

WARNING!

A frayed or torn belt could rip apart in a collision and leave you with no protection. Inspect the belt system periodically, checking for cuts, frays, or loose parts. Damaged parts must be replaced immediately. Do not disassemble or modify the system. Seat belt assemblies must be replaced after an accident if they have been damaged (bent retractor, torn webbing, etc.).

Adjustable Upper Shoulder Belt Anchorage

In the front seating positions, the shoulder belt can be adjusted upward or downward to position the belt away from your neck. Press the release button to release the anchorage, try to move it up or down to make sure that it is locked in position.

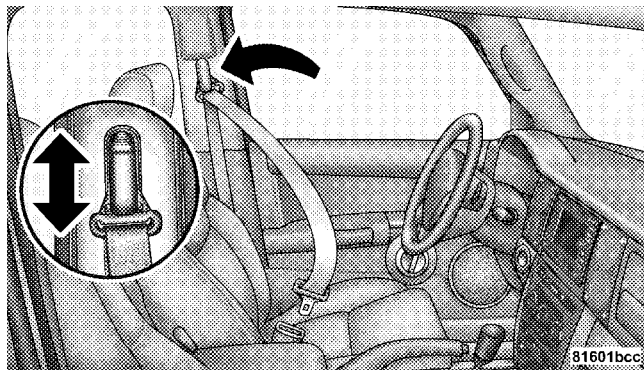

Adjusting Upper Shoulder Belt

As a guide, if you are shorter than average, you will prefer a lower position, and if you are taller than average, you'll prefer a higher position. When you release the anchorage, try to move it up or down to make sure that it is locked in position.

Automatic Locking Mode — If Equipped

In this mode, the shoulder belt is automatically pre-locked. The belt will still retract to remove any slack in the shoulder belt.

When To Use The Automatic Locking Mode

Anytime a child safety seat is installed in a second or third row seating position. Children 12 years old and under should be properly restrained in a rear seat whenever possible.

How To Use The Automatic Locking Mode

1. Buckle the combination lap and shoulder belt.
2. Grasp the shoulder portion and pull downward until the entire belt is extracted.
3. Allow the belt to retract. As the belt retracts, you will hear a clicking sound. This indicates the safety belt is now in the automatic locking mode.

How to Disengage The Automatic Locking Mode

Disconnect the combination lap/shoulder belt and allow it to retract completely to disengage the automatic locking mode and activate the vehicle sensitive (emergency) locking mode.

Energy Management Feature

This vehicle has a safety belt system with an energy management feature in the front seating positions to help further reduce the risk of injury in the event of a head-on collision.

This safety belt system has a retractor assembly that is designed to release webbing in a controlled manner. This feature is designed to help reduce the belt force acting on the occupant's chest.

WARNING!

- **The belt and retractor assembly must be replaced if the seat belt assembly “automatic locking retractor” feature or any other seat belt function is not working properly when checked according to the procedures in the Service Manual.**
- **Failure to replace the belt and retractor assembly could increase the risk of injury in collisions.**

Seat Belt Pretensioners

The driver and front passenger seat belts are equipped with a pretensioning device that is designed to remove any slack from the seat belt systems in the event of a collision. This device improves the performance of the seat belt by assuring that the belt is tight around the occupant early in a collision. Pretensioners work for all size occupants, including those in child restraints.

NOTE: These devices are not a substitute for proper seat belt placement by the occupant. The seat belt must still be worn snugly and positioned properly.

The pretensioners are triggered by the Occupant Restraint Control (ORC) Module. Like the front airbags, the pretensioners are a single use item. After a collision that is severe enough to deploy the airbags and pretensioners, they must be replaced.

Enhanced Seat Belt Use Reminder System (BeltAlert)

If the driver's seat belt has not been buckled within 60 seconds of starting the vehicle and if the vehicle speed is greater than 5 mph (8 km/h), the Enhanced Warning System (BeltAlert) will alert the driver to buckle their seat belt. The driver should also instruct all other occupants to buckle their seat belts. Once the warning is triggered, the Enhanced Warning System (BeltAlert) will continue to chime and flash the Seat Belt Warning Light for 96 seconds or until the driver's seat belt is buckled. The Enhanced Warning System (BeltAlert) will be reactivated if the driver's seat belt is unbuckled for more than 10 seconds and the vehicle speed is greater than 5 mph (8 km/h).

The Enhanced Warning System (BeltAlert) can be enabled or disabled by your authorized dealer or by following these steps:

NOTE: The following steps must occur within the first 60 seconds of the ignition switch being turned to the ON or START position. The manufacturer does not recommend deactivating the Enhanced Warning System (BeltAlert).

1. Turn the ignition switch to the OFF position, and buckle the driver's seat belt.
2. Turn the ignition key to the ACCESSORY/RUN position (engine does not need to be running), and wait for the Seat Belt Warning Light to turn off.
3. Within 60 seconds of starting the vehicle, unbuckle and then re-buckle the driver's seat belt at least three times with 10 seconds, ending with the seat belt buckled.
4. Turn the ignition key to the OFF position. A single chime will sound to signify that you have successfully completed the programming.

The Enhanced Warning System (BeltAlert) can be reactivated by repeating this procedure.

NOTE: Although the Enhanced Warning System (BeltAlert) has been deactivated, the Seat Belt Warning Light will continue to illuminate while the driver's seat belt remains unfastened.

Seat Belts and Pregnant Women

We recommend that pregnant women use the seat belts throughout their pregnancy. Keeping the mother safe is the best way to keep the baby safe.

Pregnant women should wear the lap part of the belt across the thighs and as snug across the hips as possible. Keep the belt low so that it does not come across the abdomen. That way the strong bones of the hips will take the force if there is a collision.

Seat Belt Extender

If a seat belt is too short, even when fully extended and when the adjustable upper shoulder belt anchorage (if equipped) is in its lowest position, your authorized dealer can provide you with a seat belt extender. This extender should be used only if the existing belt is not long enough. When it is not required, remove the extender and store it.

WARNING!

Using a seat belt extender when not needed can increase the risk of injury in a collision. Only use when the lap belt is not long enough when it is worn low and snug, and in the recommended seating positions. Remove and store the extender when not needed.

Driver And Front Passenger Supplemental Restraint Systems (SRS)

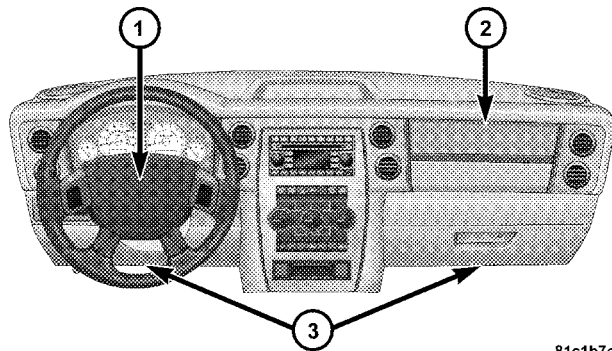

81c1b7ed

- 1 — Driver Airbag
- 2 — Passenger Airbag
- 3 — Knee Bolster

This vehicle has airbags for both the driver and right front passenger as a supplement to the seat belt restraint systems. The driver's front airbag is mounted in the steering wheel. The passenger side airbag is mounted in the instrument panel, above the glove compartment. The words SRS/AIRBAG are embossed on the airbag covers.

NOTE: The front airbags are certified to the Federal regulations that allow less forceful deployment.

The front airbags have a multistage inflator design. This may allow the airbag to have different rates of inflation that are based on collision severity and occupant size.

This vehicle is equipped with window bags to protect the driver, front, and rear passengers sitting next to a window. They are located above the side windows. Their covers are also labeled SRS/AIRBAG.

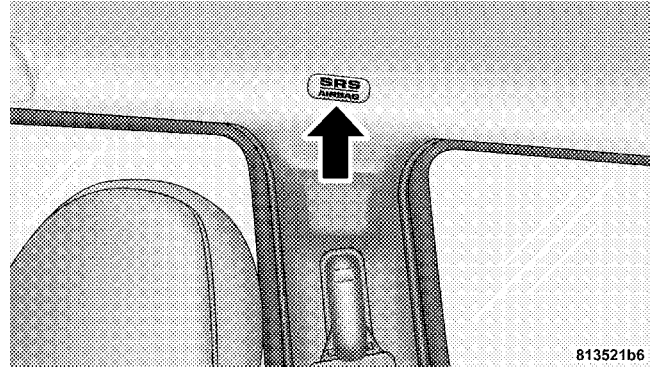

Window Airbag Location

NOTE: Airbag covers may not be obvious in the interior trim; but they will open to allow airbag deployment.

WARNING!

- **Do not put anything on or around the front airbag covers or attempt to manually open them. You may damage the airbags and you could be injured because the airbags are no longer functional. These protective covers for the airbag cushions are designed to open only when the airbags are inflating.**
- **Do not stack luggage or other cargo up high enough to block the location of the window bag. The area where the window bag is located should remain free from any obstructions.**
- **Do not have any accessory items installed which will alter the roof, including adding a sunroof to your vehicle. Do not add roof racks that require permanent attachments (bolts or screws) for installation on the vehicle roof. Do not drill into the roof of the vehicle for any reason.**
- **Do not cover or place items on the airbag covers. These items may cause serious injury during inflation.**

NOTE: Do not use a clothing bar mounted to the coat hooks in this vehicle. A clothing bar will impede the proper performance of the window bags.

The front airbags have a multi stage inflator design. This allows the airbag to have different rates of inflation that are based on collision severity. Along with the seat belts, front airbags work with the instrument panel knee bolsters to provide improved protection for the driver and front passenger. Window bags also work with seat belts to improve occupant protection.

The seat belts are designed to protect you in many types of collisions. The front airbags deploy in moderate to severe frontal collisions.

The window bag on the crash side of the vehicle is triggered in moderate to severe side collisions. In certain types of collisions, both the front and side airbags may be triggered. But even in collisions where the airbags work, you need the seat belts to keep you in the right position for the airbags to protect you properly.

Here are some simple steps you can take to minimize the risk of harm from a deploying airbag.

1. Children 12 years and under should always ride buckled up in a rear seat.

Infants in rear facing child restraints should **NEVER** ride in the front seat of a vehicle with a passenger airbag. An airbag deployment could cause severe injury or death to infants in that position.

Children that are not big enough to properly wear the vehicle seat belt should be secured in the rear seat, in a child restraint or belt-positioning booster seat. Older children who do not use child restraints or belt-positioning booster seats should ride properly buckled up in the rear seat. Never allow children to slide the shoulder belt behind them or under their arm.

If a child from 1 to 12 years old must ride in the front passenger seat because the vehicle is crowded, move the

seat as far back as possible, and use the proper child restraint. See “Child Restraint” in this section.

You should read the instructions provided with your child restraint to make sure that you are using it properly.

2. All occupants should use their lap and shoulder belts properly.

3. The driver and front passenger seats should be moved back as far as practical to allow the front airbags room to inflate.

4. Do not lean against the door or window, airbags will inflate forcefully into the space between you and the door.

5. If the airbag system in this vehicle needs to be modified to accommodate a disabled person, contact the Customer Center. Phone numbers are provided under “If You Need Assistance” in Section 9 of this manual.

WARNING!

- **Relying on the airbags alone could lead to more severe injuries in a collision. The airbags work with your seat belt to restrain you properly. In some collisions the airbags won't deploy at all. Always wear your seat belts even though you have airbags.**
- **Being too close to the steering wheel or instrument panel during airbag deployment could cause serious injury. Airbags need room to inflate. Sit back, comfortably extending your arms to reach the steering wheel or instrument panel.**
- **Side curtain airbags need room to inflate. Do not lean against the door or window. Sit upright in the center of the seat.**

Airbag System Components

The airbag system consists of the following:

- Occupant Restraint Control Module
- Airbag Warning Light
- Driver Airbag
- Passenger Airbag
- Side Curtain Airbags above Side Windows
- Side Remote Acceleration Sensors
- Driver Side Seat Track Position Sensor
- Steering Wheel and Column
- Instrument Panel
- Interconnecting Wiring
- Knee Impact Bolsters
- Front Acceleration Sensors
- Driver and Front Passenger Seat Belt Pretensioners

How The Airbag System Works

- The **Occupant Restraint Control (ORC) Module** determines if a frontal, side, or rollover collision is severe enough to require the front and/or side airbags to inflate. The front airbag inflators are designed to provide different rates of airbag inflation from direction provided by the ORC. The ORC will detect roll overs, not rear impacts.

The ORC also monitors the readiness of the electronic parts of the system whenever the ignition switch is in the START or ON positions. These include all of the items listed above except the knee bolster, the instrument panel, and the steering wheel and column. If the key is in the LOCK position, in the ACC position, or not in the ignition, the airbags are not on and will not inflate.



Also, the ORC turns on the “Airbag Warning Light” for 2.5 to 8 seconds for a self-check when the ignition is first turned on. After the self-check, the “Airbag Warning Light” will turn off. If the ORC detects a malfunction in any part of the system, it turns on the “Airbag Warning Light” either momentarily or continuously. A single chime will sound if the light comes on again after initial start up.

WARNING!

Ignoring the “Airbag Warning Light” in your instrument panel could mean you won’t have the airbags to protect you in a collision. If the light does not come on, stays on after you start the vehicle, or if it comes on as you drive, have the airbag system checked right away.

- The **Driver and Passenger Airbag/Inflator Units** are located in the center of the steering wheel and the right side of the instrument panel. When the ORC detects a collision requiring the airbags, it signals the inflator units. A large quantity of nontoxic gas is generated to inflate the front airbags. Different airbag inflation rates are possible, based on collision severity and occupant size. The steering wheel hub trim cover and the upper right side of the instrument panel separate and fold out of the way as the bags inflate to their full size. The bags fully inflate in about 50–70 milliseconds. This is about half of the time it takes to blink your eyes. The bags then quickly deflate while helping to restrain the driver and front passenger.

The driver front airbag gas is vented through the vent holes in the sides of the airbag. The passenger front airbag gas is vented through the vent holes in the sides of the airbag. In this way, the airbags do not interfere with your control of the vehicle.
- The **Side Impact SRS Side Curtain Airbags** are designed to activate only in certain side or rollover collisions. When the Occupant Restraint Control Module (ORC) detects a collision requiring the window bags to inflate, it signals the inflators on the crash side of the vehicle both sides of the vehicle if equipped with rollover sensing. A quantity of nontoxic gas is generated to inflate the window bag. The inflating window bag pushes the outside edge of the headliner out of the way and covers the window. The airbag inflates in about 30 milliseconds (about one-quarter of the time it takes to blink your eyes) with enough force to injure you if you are not belted and seated properly, or if items are positioned in the area where the window bag inflates. This especially applies to children. The window bag is only about 3 inches (8 cm) thick when it is inflated.

- The **Knee Impact Bolsters** help protect the knees of the driver and the front passenger, and position everyone for the best interaction with the front airbag.

If A Deployment Occurs

The airbag system is designed to deploy when the Occupant Restraint Control (ORC) Module detects a moderate-to-severe frontal collision, to help restrain the driver and front passenger, and then to immediately deflate.

NOTE: A frontal collision that is not severe enough to need airbag protection will not activate the system. This does not mean something is wrong with the airbag system.

If you do have a collision which deploys the airbags, any or all of the following may occur:

- The nylon airbag material may sometimes cause abrasions and/or skin reddening to the driver and front

passenger as the airbags deploy and unfold. The abrasions are similar to friction rope burns or those you might get sliding along a carpet or gymnasium floor. They are not caused by contact with chemicals. They are not permanent and normally heal quickly. However, if you haven't healed significantly within a few days, or if you have any blistering, see your doctor immediately.

- As the airbags deflate you may see some smoke-like particles. The particles are a normal by-product of the process that generates the nontoxic gas used for airbag inflation. These airborne particles may irritate the skin, eyes, nose, or throat. If you have skin or eye irritation, rinse the area with cool water. For nose or throat irritation, move to fresh air. If the irritation continues, see your doctor. If these particles settle on your clothing, follow the garment manufacturer's instructions for cleaning.

- It is not advisable to drive your vehicle after the airbags have deployed. If you are involved in another collision, the airbags will not be in place to protect you.

WARNING!

Deployed airbags and seat belt pretensioners cannot protect you in another collision. Have the airbags, seat belt pretensioners, and seat belt retractor assembly, replaced by an authorized dealer as soon as possible.

Enhanced Accident Response Feature

If the airbags deploy after an impact and the electrical system remains functional, vehicles equipped with power door locks will unlock automatically. The hazard lights will flash and the fuel will be cut off to the engine. In addition, after the vehicle has stopped moving, the interior lights will illuminate to aid visibility and remain lit until the ignition switch is turned off.

NOTE: The interior lights can only be deactivated if the key is removed from the ignition switch or the vehicle is driven.

Maintaining Your Airbag System

WARNING!

- **Modifications to any part of the airbag system could cause it to fail when you need it. You could be injured if the airbag system is not there to protect you. Do not modify the components or wiring, including adding any kind of badges or stickers to the steering wheel hub trim cover or the upper right side of the instrument panel. Do not modify the front bumper or vehicle body structure.**
- **You need proper knee impact protection in a collision. Do not mount or locate any aftermarket equipment on or behind the knee bolsters.**
- **It is dangerous to try to repair any part of the airbag system yourself. Be sure to tell anyone who works on your vehicle that it has an airbag system.**

NOTE: Perchlorate Material – special handling may apply, See www.dtsc.ca.gov/hazardouswaste/perchlorate

Airbag Warning Light

You will want to have the airbag system ready to inflate for your protection in an impact. The airbag system is designed to be maintenance free. If any of the following occurs, have an authorized dealer service the system promptly:

- Does not come on during the 2.5 to 8 seconds after the ignition switch is first turned on.
- Remains on after the 2.5 to 8 second interval.
- Flickers, or comes on and remains on for any period of time while driving.

Event Data Recorder (EDR)

In the event of an accident, your vehicle is designed to record up to 5-seconds of specific vehicle data parameters (see the following list) in an event data recorder prior to the moment of airbag deployment, or near deployment, and up to a quarter second of high-speed deceleration data during and/or after air bag deployment or near-deployment. EDR data are **ONLY** recorded if an airbag deploys, or nearly deploys, and are otherwise unavailable.

NOTE:

- A near-deployment event occurs when the airbag sensor detects severe vehicle deceleration usually indicative of a crash, but not severe enough to warrant airbag deployment.
- Under certain circumstances, EDR data may not be recorded (e.g., loss of battery power).

In conjunction with other data gathered during a complete accident investigation, the electronic data may be used by DaimlerChrysler Corporation and others to learn more about the possible causes of crashes and associated injuries in order to assess and improve vehicle performance. In addition to crash investigations initiated by DaimlerChrysler Corporation, such investigations may be requested by customers, insurance carriers, government officials, and professional crash researchers, such as those associated with universities, and with hospital and insurance organizations.

In the event that an investigation is undertaken by DaimlerChrysler Corporation (regardless of initiative), the company or its designated representative will first obtain permission of the appropriate custodial entity for the vehicle (usually the vehicle owner or lessee) before accessing the electronic data stored, unless ordered to download data by a court with legal jurisdiction (i.e., pursuant to a warrant). A copy of the data will be

provided to the custodial entity upon request. General data that does not identify particular vehicles or crashes may be released for incorporation in aggregate crash databases, such as those maintained by the US government and various states. Data of a potentially sensitive nature, such as would identify a particular driver, vehicle, or crash, will be treated confidentially. Confidential data will not be disclosed by DaimlerChrysler Corporation to any third party except when:

1. Used for research purposes, such as to match data with a particular crash record in an aggregate database, provided confidentiality of personal data is thereafter preserved
2. Used in defense of litigation involving a DaimlerChrysler Corporation product
3. Requested by police under a legal warrant
4. Otherwise required by law

Data Parameters that May Be Recorded:

- Diagnostic trouble code(s) and warning lamp status for electronically-controlled safety systems, including the airbag system
- Airbag disable lamp status (if equipped)
- "Time" of airbag deployment (in terms of ignition cycles and vehicle mileage)
- Airbag deployment level (if applicable)
- Impact acceleration and angle
- Seat belt status
- Brake status (service and parking brakes)
- Accelerator status (including vehicle speed)
- Engine control status (including engine speed)
- Transmission gear selection

- Cruise control status
- Traction/stability control status
- Tire pressure monitoring system status

Child Restraint

Everyone in your vehicle needs to be buckled up all the time — babies and children, too. Every state in the United States and all Canadian provinces require that small children ride in proper restraint systems. This is the law, and you can be prosecuted for ignoring it.

Children 12 years and under should ride properly buckled up in a rear seat, if available. According to crash statistics, children are safer when properly restrained in the rear seats rather than in the front.

There are different sizes and types of restraints for children from newborn size to the child almost large enough for an adult safety belt. Always check the child seat Owner's Manual to ensure you have the right seat for your child. Use the restraint that is correct for your child:

WARNING!

In a collision, an unrestrained child, even a tiny baby, can become a missile inside the vehicle. The force required to hold even an infant on your lap can become so great that you could not hold the child, no matter how strong you are. The child and others could be badly injured. Any child riding in your vehicle should be in a proper restraint for the child's size.

Infants and Child Restraints

- Safety experts recommend that children ride rearward-facing in the vehicle until they are at least one year old **and** weigh at least 20 lbs (9 kg). Two types of child restraints can be used rearward-facing: infant carriers and “convertible” child seats.
- The infant carrier is only used rearward-facing in the vehicle. It is recommended for children who weigh up to about 20 lbs (9 kg). “Convertible” child seats often have a higher weight limit in the rearward-facing direction than infant carriers do, so they can be used rearward-facing by children who weigh more than 20 lbs (9 kg) but are less than one year old. Both types of child restraints are held in the vehicle by the lap/shoulder belt or the LATCH child restraint anchorage system (Refer to LATCH — Child Seat Anchorage System in this section.)

- Rearward-facing child seats must **NEVER** be used in the front seat of a vehicle with the front passenger airbag unless the airbag is turned off. An airbag deployment could cause severe injury or death to infants in this position.

WARNING!

- **Improper installation can lead to failure of an infant or child restraint. It could come loose in a collision. The child could be badly injured or killed. Follow the manufacturer’s directions exactly when installing an infant or child restraint.**
- **A rearward facing infant restraint should only be used in a rear seat. A rearward facing infant restraint in the front seat may be struck by a deploying passenger airbag which may cause severe or fatal injury to the infant.**

Here are some tips for getting the most out of your child restraint:

- Before buying any restraint system, make sure that it has a label certifying that it meets all applicable Safety Standards. The manufacturer also recommends that you try a child restraint in the vehicle seats where you will use it before you buy it.
- The restraint must be appropriate for your child's weight and height. Check the label on the restraint for weight and height limits.
- Carefully follow the instructions that come with the restraint. If you install the restraint improperly, it may not work when you need it.
- The front passenger seat belt is equipped with a cinching latch plate. The second and third row seating positions have automatic locking retractors. Both types of seat belts are designed to keep the lap portion tight

around the child restraint so that it is not necessary to use a locking clip. If the seat belt has a cinching latch plate, pulling up on the shoulder portion of the lap/shoulder belt will tighten the belt (the cinching latch plate will keep the belt tight, however, any seat belt system will loosen with time, so check the belt occasionally and pull it tight if necessary). For the second and third row seat belts with the automatic locking retractor, pull the belt from the retractor until there is enough to allow you to pass through the child restraint and slide the latch plate into the buckle. Then, pull the belt until it is fully extracted from the retractor. Allow the belt to return to the retractor, pulling on the excess webbing to tighten the lap portion about the child restraint. For additional information, refer to "Automatic Locking Mode" earlier in this section.

- In your vehicle's 2nd row outboard seating positions, you may have trouble tightening the lap/shoulder belt on the child restraint because the buckle or latch plate

is too close to the belt path opening on the restraint. Disconnect the latch plate from the buckle and twist the short buckle-end belt several times to shorten it. Insert the latch plate into the buckle with the release button facing out.

- If the belt still cannot be tightened, or if pulling and pushing on the restraint loosens the belt, disconnect the latch plate from the buckle, turn the buckle around, and insert the latch plate into the buckle again. If you still cannot make the child restraint secure, try a different seating position.
- Buckle the child into the restraint exactly as the manufacturer's instructions tell you.
- When your child restraint is not in use, secure it in the vehicle with the seat belt or remove it from the vehicle. Do not leave it loose in the vehicle. In a sudden stop or collision, it could strike the occupants or seat backs and cause serious personal injury.

NOTE: For additional information refer to www.seatcheck.org or call 1-866-SEATCHECK.

Older Children and Child Restraints

Children who weigh more than 20 lbs (9 kg) and who are older than one year can ride forward-facing in the vehicle. Forward-facing child seats and convertible child seats used in the forward-facing direction, are for children who weigh 20 to 40 lbs (9 to 18 kg), and who are older than one year. These child seats are also held in the vehicle by the lap/shoulder belt or the LATCH child restraint anchorage system (Refer to LATCH — Child Seat Anchorage System in this section.)

The belt-positioning booster seat is for children weighing more than 40 lbs (18 kg), but who are still too small to fit the vehicle's seat belts properly. If the child cannot sit with knees bent over the vehicle's seat cushion while the child's back is against the seat back, they should use a

belt-positioning booster seat. The child and belt-positioning booster seat are held in the vehicle by the lap/shoulder belt.

Children Too Large for Booster Seats

Children who are large enough to wear the shoulder belt comfortably, and whose legs are long enough to bend over the front of the seat when their back is against the seat back, should use the lap/shoulder belt in a rear seat.

- Make sure that the child is upright in the seat.
- The lap portion should be low on the hips and as snug as possible.
- Check belt fit periodically. A child's squirming or slouching can move the belt out of position.
- If the shoulder belt contacts the face or neck, move the child closer to the center of the vehicle. Never allow a child to put the shoulder belt under an arm or behind their back.

LATCH — Child Seat Anchorage System (Lower Anchors and Tether for Children)

Your vehicle's second row seat is equipped with the child restraint anchorage system called LATCH. The LATCH system provides for the installation of the child restraint without using the vehicle's seat belts, instead securing the child restraint using lower anchorages and upper tether straps from the child restraint to the vehicle structure.

LATCH-compatible child restraint systems are now available. However, because the lower anchorages are to be introduced over a period of years, child restraint systems having attachments for those anchorages will continue to also have features for installation using the vehicle's seat belts. Child restraints having tether straps and hooks for connection to the top tether anchorages have been available for some time. For some older child restraints, many child restraint manufacturers offer add-on tether strap

kits or retro-fit kits. You are urged to take advantage of all the available attachments provided with your child restraint in any vehicle.

NOTE: When using the LATCH attaching system to install a child restraint, please ensure that all seat belts not being used for occupant restraints are stowed and out of reach of children. Remind all children in the vehicle that the seat belts are not toys and should not be played with, and never leave your child unattended in the vehicle.

The second row outboard seating positions have lower anchorages that are capable of accommodating LATCH-compatible child seats having flexible, webbing-mounted lower attachments. Child seats with fixed lower attachments must be installed in the outboard positions only. Regardless of the specific type of lower attachment, **NEVER** install LATCH-compatible child seats such that two seats share a common lower anchorage.

If you are installing LATCH-compatible child restraints in adjacent rear seating positions, you can use the LATCH anchors or the vehicle's seat belt for the outboard position, but you must use the vehicle's seat belt at the center position. If your child restraints are not LATCH-compatible, you can only install the child restraints using the vehicle's seat belts. Please refer to the next section for typical installation instructions.

Installing the LATCH-Compatible Child Restraint System

We urge that you carefully follow the directions of the manufacturer when installing your child restraint. Not all child restraint systems will be installed as described here. Again, carefully follow the installation instructions that were provided with the child restraint system.

The rear seat lower anchorages are round bars, located at the rear of the seat cushion where it meets the seat back, and are just visible when you lean into the rear seat to

install the child restraint. You will easily feel them if you run your finger along the intersection of the seatback and seat cushion surfaces.

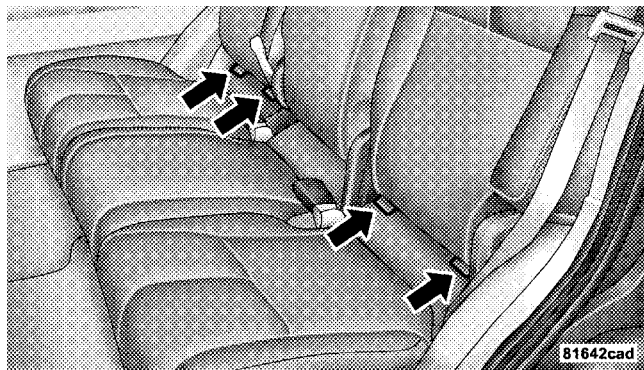

Latch Anchorages

In addition, there are tether strap anchorages behind each rear outboard seating position located on the back of the seat.

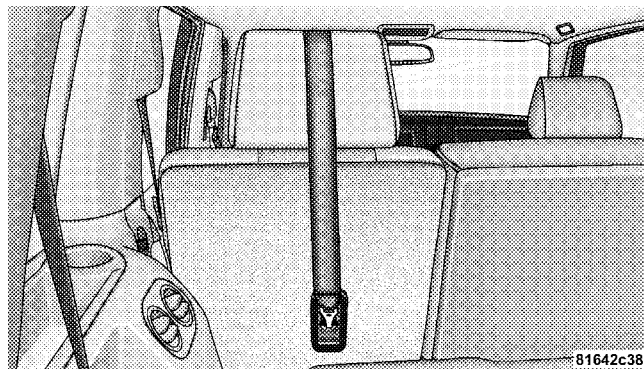

Tether Strap Mounting

Many, but not all restraint systems will be equipped with separate straps on each side, with each having a hook or connector for attachment to the lower anchorage and a means of adjusting the tension in the strap. Forward-facing toddler restraints and some rear-facing infant restraints will also be equipped with a tether strap, a

hook for attachment to the tether strap anchorage and a means of adjusting the tension of the strap.

You will first loosen the adjusters on the lower straps and on the tether strap so that you can more easily attach the hooks or connectors to the vehicle anchorages. Next attach the lower hooks or connectors over the top of the anchorage bars, pushing aside the seat cover material. Then, locate the tether anchorage directly behind the seat where you are placing the child restraint and attach the tether strap to the anchorage, being careful to route the tether strap to provide the most direct path between the anchor and the child restraint. Finally, tighten all three straps as you push the child restraint rearward and downward into the seat, removing slack in the straps according to the child restraint manufacturer's instructions.

WARNING!

Improper installation of a child restraint to the LATCH anchorages can lead to failure of an infant or child restraint. The child could be badly injured or killed. Follow the manufacturer's directions exactly when installing an infant or child restraint.

2

Installing Child Restraints Using the Vehicle Seat Belt

The passenger seat belts are equipped with either cinching latch plates or automatic locking retractors, which are designed to keep the lap portion tight around the child restraint so that it is not necessary to use a locking clip. If the seat belt has a cinching latch plate, pulling up on the shoulder portion of the lap/shoulder belt will tighten the belt. The cinching latch plate will keep the belt tight, however, any seat belt system will loosen with time, so check the belt occasionally and pull it tight if necessary.

If the seat belt has an automatic locking retractor, pull the belt from the retractor until there is enough to allow you to pass through the child restraint and slide the latch plate into the buckle. Then, pull the belt until it is all extracted from the retractor. Allow the belt to return to the retractor, pulling on the excess webbing to tighten the lap portion about the child restraint. Refer to “Automatic Locking Mode” earlier in this section.

In the rear seat, you may have trouble tightening the lap/shoulder belt on the child restraint because the buckle or latch plate is too close to the belt path opening on the restraint. Disconnect the latch plate from the buckle and twist the short buckle-end belt several times to shorten it. Insert the latch plate into the buckle with the release button facing out.

If the belt still can't be tightened, or if by pulling and pushing on the restraint loosens the belt, you may need to do something more. Disconnect the latch plate from

the buckle, turn the buckle around, and insert the latch plate into the buckle again. If you still can't make the child restraint secure, try a different seating position.

To attach a child restraint tether strap:

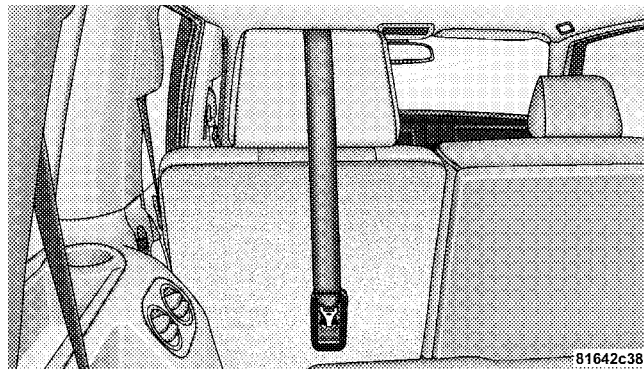

Tether Strap Mounting

Route the tether strap over the seat back and attach the hook to the tether anchor located on the back of the seat.

For the outboard seating positions, route the tether over the head rests, and attach the hook to the tether anchor located on the back of the seat.

WARNING!

An incorrectly anchored tether strap could lead to increased head motion and possible injury to the child. Use only the anchor positions directly behind the child seat to secure a child restraint top tether strap.

Transporting Pets

Airbags deploying in the front seat could harm your pet. An unrestrained pet will be thrown about and possibly injured, or injure a passenger during panic braking or in a collision. Pets should be restrained in the rear seat in pet harnesses or pet carriers that are secured by seat belts.

ENGINE BREAK-IN RECOMMENDATIONS

A long break-in period is not required for the engine in your new vehicle.

Drive moderately during the first 300 miles (500 km). After the initial 60 miles (100 km), speeds up to 50 or 55 mph (80 or 90 km/h) are desirable.

While cruising, brief full-throttle acceleration, within the limits of local traffic laws, contributes to a good break-in. Wide-open throttle acceleration in low gear can be detrimental and should be avoided.

The engine oil installed in the engine at the factory is a high quality energy conserving type lubricant. Oil changes should be consistent with anticipated climate conditions under which vehicle operations will occur. The recommended viscosity and quality grades are shown in Section 7 of this manual. **NON-DETERGENT OR STRAIGHT MINERAL OILS MUST NEVER BE USED.**

70 THINGS TO KNOW BEFORE STARTING YOUR VEHICLE

A new engine may consume some oil during its first few thousand miles (kilometers) of operation. This should be considered as a normal part of the break-in and not interpreted as an indication of difficulty.

SAFETY TIPS

Exhaust Gas

WARNING!

Exhaust gases can injure or kill. They contain carbon monoxide (CO) which is colorless and odorless. Breathing it can make you unconscious and can eventually poison you. To avoid breathing (CO) follow the safety tips below.

- Do not inhale exhaust gases. They contain carbon monoxide, a colorless and odorless gas which can kill. Never run the engine in a closed area, such as a garage, and never sit in a parked vehicle with the engine running for an extended period. If the vehicle is stopped in an open area with engine running for more than a short period, adjust the ventilation system to force fresh, outside air into the vehicle.
- Guard against carbon monoxide with proper maintenance. Have the exhaust system inspected every time the vehicle is raised. Have any abnormal conditions repaired promptly. Until repaired, drive with all side windows fully open.
- Always run the climate control in panel or floor mode when driving with any windows open, even if only slightly, to help keep fresh air circulating inside vehicle. Otherwise poisonous gases could be drawn into the vehicle.

Safety Checks You Should Make Inside The Vehicle

Seat Belts

Inspect the belt system periodically, checking for cuts, frays and loose parts. Damaged parts must be replaced immediately. Do not disassemble or modify the system.

Seat belt assemblies must be replaced after an accident if they have been damaged (bent retractor, torn webbing, etc.). If there is any question regarding belt or retractor condition, replace the belt.

Airbag Warning Light

The light should come on and remain on for 6 to 8 seconds as a bulb check when the ignition switch is first turned on. If the bulb is not lit during starting, have it replaced. If the light stays on or comes on while driving, have the system checked by an authorized dealer.

Defrosters

Check operation by selecting the defrost mode and place the blower control on high speed. You should be able to feel the air directed against the windshield. See your authorized dealer for service if your defroster is inoperable.

Safety Checks You Should Make Outside The Vehicle

Tires

Examine tires for excessive tread wear or uneven wear patterns. Check for stones, nails, glass, or other objects lodged in the tread. Inspect for tread cuts or sidewall cracks. Check wheel nuts for tightness and tires (including spare) for proper pressure.

Lights

Have someone observe the operation of all exterior lights while you work the controls. Check turn signal and high beam indicator lights on the instrument panel.

Fluid Leaks

Check area under vehicle after overnight parking for fuel, coolant, oil or other fluid leaks. Also, if gasoline fumes are detected, the cause should be located and corrected immediately.

UNDERSTANDING THE FEATURES OF YOUR VEHICLE

CONTENTS

■ Mirrors78	□ Heated Remote Control Mirrors — If Equipped81
□ Inside Day/Night Mirror78	□ Lighted Vanity Mirrors — If Equipped81
□ Automatic Dimming Mirror — If Equipped78	■ Hands-Free Communication (UConnect™) — If Equipped82
□ Outside Mirrors79	□ Operation84
□ Exterior Mirrors Folding Feature80	□ Phone Call Features91
□ Driver's And Front Passenger Outside Automatic Dimming Mirror — If Equipped80	□ UConnect™ System Features94
□ Power Remote Control Outside Mirrors — If Equipped80	□ Advanced Phone Connectivity98

74 UNDERSTANDING THE FEATURES OF YOUR VEHICLE

- Things You Should Know About Your UConnect™ System 100
- General Information 108
- Seats 108
 - Front Manual Seat Adjustment 108
 - Front Seat Adjustment — Recline 108
 - Manual Lumbar Support Adjustment 109
 - 8 - Way Driver's Power Seat 110
 - 4 - Way Passenger's Power Seat — If Equipped 110
 - Head Restraints 110
 - Front Heated Seats—If Equipped 111
 - 40/20/40 Second Row Folding Seat 113
 - 50/50 Third Row Folding Seat — If Equipped 117
- Driver Memory Seat — If Equipped 118
 - Setting Memory Positions And Linking Remote Keyless Entry Transmitter To Memory 119
 - Memory Position Recall 120
 - To Disable A Transmitter Linked To Memory . . 121
 - Easy Entry/Exit Seat 122
- To Open And Close The Hood 123
- Lights 124
 - Multi-Function Control Lever 124
 - Battery Saver Feature—Exterior/Interior Lights 125
 - Headlights And Parking Lights 125

<ul style="list-style-type: none"> □ Automatic Headlight System — If Equipped . . .126 □ SmartBeams — If Equipped126 □ Instrument Panel And Interior Lights127 □ Daytime Running Lights — If Equipped128 □ Lights-On Reminder128 □ Fog Lights — If Equipped128 □ Turn Signals129 □ High Beam Switch129 □ Passing Light129 □ Headlight Time Delay129 □ Interior Lights130 □ Courtesy/Reading Lights130 ■ Windshield Wipers And Washers131 	<ul style="list-style-type: none"> □ Mist132 □ Speed Sensitive Intermittent Wiper System . . .132 □ Rain Sensing Wipers—If Equipped133 ■ Tilt/Telescoping Steering Column134 ■ Adjustable Pedals — If Equipped135 ■ Electronic Speed Control — If Equipped136 <ul style="list-style-type: none"> □ Electronic Speed Control Operation136 □ To Activate137 □ To Set At A Desired Speed137 □ To Deactivate138 □ To Resume Speed138 □ To Vary The Speed Setting138 □ To Accelerate For Passing139
---	--

76 UNDERSTANDING THE FEATURES OF YOUR VEHICLE

- Electronic Brake Control System 139
 - ABS (Anti-Lock Brake System) 139
 - TCS (Traction Control System) 140
 - BAS (Brake Assist System) 141
 - ERM (Electronic Roll Mitigation) 142
 - ESP (Electronic Stability Program) 143
 - TSC (Trailer Sway Control) 147
 - HSA (Hill Start Assist) (4WD Models With NV245 Two-Speed Transfer Case Only) 148
 - HDC (Hill Descent Control) (4WD Models With NV245 Two-Speed Transfer Case Only) . . 150
 - ESP/BAS Warning Lamp And ESP/TCS Indicator Light 152
- Rear Park Assist System— If Equipped 153
 - Rear Park Assist Sensors 154
 - Rear Park Assist Warning Display 154
 - Enable/Disable The Rear Park Assist System . . 156
 - Service The Rear Park Assist System 156
 - Cleaning The Rear Park Assist System 157
- Rear Camera — If Equipped 157
 - Turning The Rear Camera On 157
 - Turning The Rear Camera Off 158
- Overhead Console — If Equipped 158
- Garage Door Opener — If Equipped 159
 - Programming HomeLink® 160
 - Gate Operator/Canadian Programming 163
 - Using HomeLink® 163

<ul style="list-style-type: none"> □ Reprogramming a Single HomeLink® Button . . .164 □ Security164 □ Troubleshooting Tips164 □ General Information165 ■ Power Sunroof — If Equipped165 <ul style="list-style-type: none"> □ Opening Sunroof - Express166 □ Closing Sunroof - Express166 □ Pinch Protect Feature166 □ Pinch Protect Override167 □ Venting Sunroof - Express167 □ Sunshade Operation167 □ Wind Buffeting167 □ Sunroof Maintenance168 □ Ignition Off Operation168 	<ul style="list-style-type: none"> □ Sunroof Fully Closed168 ■ Command-View™ Skylights — If Equipped168 ■ Power Outlet169 <ul style="list-style-type: none"> □ Front Power Outlet169 □ Rear Power Outlet — If Equipped169 ■ Power Inverter — If Equipped170 ■ Cup Holders172 ■ Cargo Area Features174 <ul style="list-style-type: none"> □ Cargo Load Floor174 ■ Rear Window Features176 <ul style="list-style-type: none"> □ Rear Window Wiper/Washer176 □ Rear Window Defroster — If Equipped177 ■ Roof Luggage Rack — If Equipped177
--	---

MIRRORS

Inside Day/Night Mirror

The mirror should be adjusted to center on the view through the rear window.

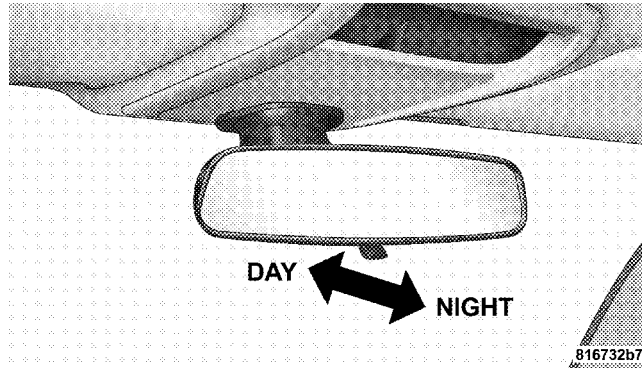

Adjusting Rear View Mirror

A two-point pivot system allows for horizontal and vertical adjustment of the mirror.

Annoying headlight glare from vehicles behind you can be reduced by moving the small control under the mirror to the night position (toward rear of vehicle). The mirror should be adjusted while set in the day position (toward windshield).

Automatic Dimming Mirror — If Equipped

This mirror automatically adjusts for annoying headlight glare from vehicles behind you. You can turn the feature on or off by pressing the button at the base of the mirror. A light next to the button will indicate when the dimming feature is activated.

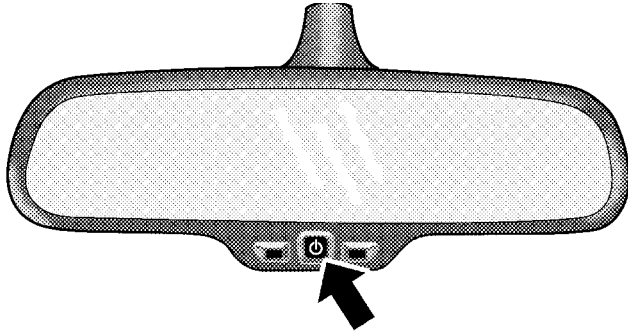

817892c4

Automatic Dimming Mirror

CAUTION!

To avoid damage to the mirror during cleaning, never spray any cleaning solution directly onto the mirror. Apply the solution onto a clean cloth and wipe the mirror clean.

Outside Mirrors

To receive maximum benefit, adjust the outside mirrors to center on the adjacent lane of traffic with a slight overlap of the view obtained on the inside mirror.

WARNING!**3**

Vehicles and other objects seen in the passenger side convex mirror will look smaller and farther away than they really are. Relying too much on your passenger side convex mirror could cause you to collide with another vehicle or other object. Use your inside mirror when judging the size or distance of a vehicle seen in the passenger side convex mirror. Some vehicles will not have a convex passenger side mirror.

Exterior Mirrors Folding Feature

All exterior mirrors are hinged and may be moved either forward or rearward to resist damage. The hinges have three detent positions; full forward, full rearward, and normal.

Driver's and Front Passenger Outside Automatic Dimming Mirror — If Equipped

If your vehicle is equipped with outside automatic dimming mirrors, they will operate when the inside automatic dimming mirror is on. The outside mirrors operate off the inside mirror switch and will automatically adjust for annoying headlight glare when the inside mirror does.

Power Remote Control Outside Mirrors — If Equipped

The power mirror switch is located on the driver's door trim panel next to the power door lock switch. A rotary knob selects the left mirror, right mirror, or off position.

After selecting a mirror move the knob in the same direction you want the mirror to move. Use the center off position to guard against accidentally moving a mirror position.

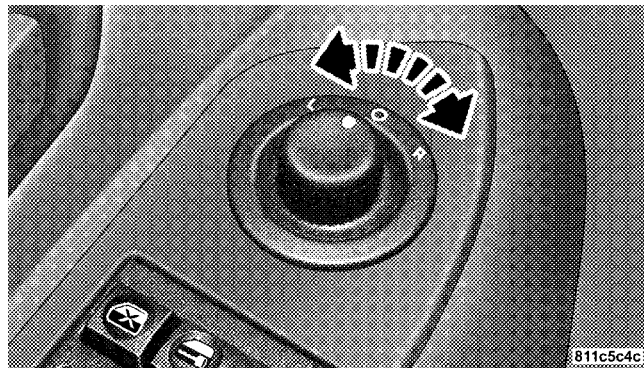

Power Mirror Switches

Power mirror preselected positions can be controlled by the optional Memory Seat Feature. Refer to “Driver Memory Seat” in this section for details.

Heated Remote Control Mirrors — If Equipped



These mirrors are heated to melt frost or ice. This feature is activated whenever you turn on the rear window defrost.

Lighted Vanity Mirrors — If Equipped

To access a lighted vanity mirror, flip down one of the visors.

Lift the cover to reveal the mirror. The light will turn on automatically.

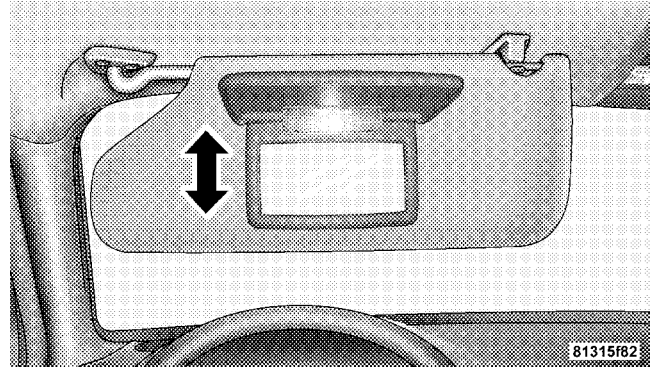

3

Lighted Vanity Mirror

Sun Visor Extension (If Equipped)

This feature has a pull out extension on the sun visor for increased coverage.

HANDS-FREE COMMUNICATION (UConnect™) — IF EQUIPPED

NOTE: The sales code RER radio contains an integrated Hands-Free Communication (UConnect™) system. Refer to your “Navigation User’s Manual” for UConnect™ system operating instructions for this radio.

UConnect™ is a voice-activated, hands-free, in-vehicle communications system. UConnect™ allows you to dial a phone number with your cellular phone using simple voice commands (e.g., “Call” ... “Mike” ... “Work” or “Dial” ... “248-555-1212”). Your cellular phone’s audio is transmitted through your vehicle’s audio system; the system will automatically mute your radio when using the UConnect™ system.

NOTE: The UConnect™ system use requires a cellular phone equipped with the Bluetooth “Hands-Free Profile,” version 0.96 or higher. See UConnect™ website for supported phones.

NOTE: For UConnect™ customer support, visit the following web sites:

- www.chrysler.com/uconnect
- www.dodge.com/uconnect
- www.jeep.com/uconnect
- or call 1-877-855-8400

UConnect™ allows you to transfer calls between the system and your cellular phone as you enter or exit your vehicle, and enables you to mute the system’s microphone for private conversation.

The UConnect™ phone book enables you to store up to 32 names and four numbers per name. Each language has a separate 32-name phone book accessible only in that language. This system is driven through your Bluetooth™ Hands-Free profile cellular phone. UConnect™ features Bluetooth™ technology - the global standard that enables different electronic devices to connect to each other without wires or a docking station, so UConnect works no matter where you stow your cellular phone (be it your purse, pocket, or briefcase), as long as your phone is turned on and has been paired to the vehicle's UConnect™ system. The UConnect™ system allows up to seven cellular phones to be linked to system. Only one linked (or paired) cellular phone can be used with the system at a time. The system is available in English, Spanish, or French languages (as equipped).

Phone Button



The rearview mirror contains the microphone for the system (depending on the type of mirror and radio equipped), and either the radio or the mirror has the two control buttons (Phone Button and Voice Recognition Button) that will enable you to access the system.

3

Voice Recognition Button



Actual button location may vary with radio. The individual buttons are described in the "Operation" section.

The UConnect™ system can be used with any Hands-Free Profile certified Bluetooth™ cellular phone. See UConnect™ website for supported phones. If your cellular phone supports a different profile (e.g., Headset Profile) you may not be able to use any UConnect™ features. Refer to your cellular service provider or the phone manufacturer for details.

The UConnect™ system is fully integrated with the vehicle's audio system. The volume of the UConnect™ system can be adjusted either from the radio volume control knob or from the steering wheel radio control (right switch), if so equipped.

The radio display will be used for visual prompts from the UConnect™ system such as "CELL" or caller ID on certain radios.

Operation

Voice commands can be used to operate the UConnect™ system and to navigate through the UConnect™ menu structure. Voice commands are required after most UConnect™ system prompts. You will be prompted for a specific command and then guided through the available options.

- Prior to giving a voice command, one must wait for the beep, which follows the "Ready" prompt or another prompt.

- For certain operations, compound commands can be used. For example, instead of saying "Setup" and then "Phone Pairing," the following compound command can be said: "Setup Phone Pairing."
- For each feature explanation in this section, only the combined form of the voice command is given. You can also break the commands into parts and say each part of the command, when you are asked for it. For example, you can use the combined form voice command "Phonebook New Entry," or you can break the combined form command into two voice commands: "Phonebook" and "New Entry." Please remember, the UConnect™ system works best when you talk in a normal conversational tone, as if speaking to some one sitting eight feet away from you.

Voice Command Tree

Refer to "Voice Tree" at the end of this section.

Help Command

If you need assistance at any prompt, or if you want to know your options at any prompt, say "Help" following the beep. The UConnect™ system will play all the options at any prompt if you ask for help.

To activate the UConnect™ system from idle, simply press the "Phone" button and follow audible prompts for directions. All UConnect™ system sessions begin with a press of the "Phone" button on the radio control head.

Cancel Command

At any prompt, after the beep, you can say "Cancel" and you will be returned to the main menu. However, in a few instances the system will take you back to the previous menu.

Pair (Link) UConnect™ System to a Cellular Phone

To begin using your UConnect™ system, you must pair your compatible Bluetooth™ enabled cellular phone.

To complete the pairing process, you will need to reference your cellular phone owner's manual. The UConnect™ website may also provide detailed instructions for pairing.

The following are general phone to UConnect™ System pairing instructions:

- Press the "Phone" button to begin.
- After the "Ready" prompt and the following beep, say "Setup Phone Pairing."
- When prompted, after the beep, say "Pair a Phone" and follow the audible prompts.
- You will be asked to say a four-digit pin number, which you will later need to enter into your cellular. You can enter any four-digit pin number. You will not need to remember this pin number after the initial pairing process.

- For identification purposes, you will be prompted to give the UConnect™ system a name for your cellular phone. Each cellular phone that is paired should be given a unique phone name.
- You will then be asked to give your cellular phone a priority level between 1 and 7, 1 being the highest priority. You can pair up to seven cellular phones to your UConnect™ system. However, at any given time, only one cellular phone can be in use, connected to your UConnect™ System. The priority allows the UConnect™ system to know which cellular phone to use if multiple cellular phones are in the vehicle at the same time. For example, if priority 3 and priority 5 phones are present in the vehicle, the UConnect™ system will use the priority 3 cellular phone when you make a call. You can select to use a lower priority cellular phone at any time (refer to "Advanced Phone Connectivity").

Dial by Saying a Number

- Press the "Phone" button to begin.
- After the "Ready" prompt and the following beep, say "Dial."
- System will prompt you to say the number you want call.
- For example, you can say "234-567-8901." The phone number that you enter must be of valid length and combination. Based on the country in which the vehicle was purchased, the UConnect™ limits the user from dialing invalid combination of numbers. For example, in USA, 234-567-890 is nine digits long, which is not a valid USA phone number - the closest valid phone number has ten digits.
- The UConnect™ system will confirm the phone number and then dial. The number will appear in the display of certain radios.

Call by Saying a Name

- Press the “Phone” button to begin.
- After the “Ready” prompt and the following beep, say “Call.”
- System will prompt you to say the name of the person you want call.
- After the “Ready” prompt and the following beep, say the name of the person you want to call. For example, you can say “John Doe,” where John Doe is a previously stored name entry in the UConnect™ phone book. Refer to “Add Names to Your UConnect™ Phonebook,” to learn how to store a name in the phone book.
- The UConnect™ system will confirm the name and then dial the corresponding phone number, which may appear in the display of certain radios.

Add Names to Your UConnect™ Phonebook

NOTE: Adding names to phone book is recommended when vehicle is not in motion.

- Press the “Phone” button to begin.
- After the “Ready” prompt and the following beep, say “Phonebook New Entry.”
- When prompted, say the name of the new entry. Use of long names helps the voice recognition and it is recommended. For example, say “Robert Smith” or “Robert” instead of “Bob.”
- When prompted, enter the number designation (e.g., “Home,” “Work,” “Mobile,” or “Pager”). This will allow you to store multiple numbers for each phone book entry, if desired.
- When prompted, recite the phone number for the phone book entry that you are adding.

After you are finished adding an entry into the phone book, you will be given the opportunity to add more phone numbers to the current entry or to return to the main menu.

The UConnect™ system will allow you to enter up to 32 names in the phone book with each name having up to four associated phone numbers and designations. Each language has a separate 32-name phone book accessible only in that language.

Phonebook Download

UConnect™ allows the user to download entries from their phone via Bluetooth. To use this feature, press the “Phone” button and say “Phonebook Download.” System prompts “Ready to accept vcard entry via Bluetooth...” The system is now ready to accept phonebook entries from your phone using the Bluetooth Object

Exchange Profile (OBEX). Please see your phone owners’ manual for specific instructions on how to send these entries from your phone.

NOTE:

- Phone handset must support Bluetooth OBEX transfers of phonebook entries to use this feature.
- Some phones cannot send phonebook entries if they are already connected to any system via Bluetooth, and you may see a message on the phone display that the Bluetooth link is busy. In this case, the user must first disconnect or drop the Bluetooth connection to the UConnect™ and then send the address book entry via Bluetooth. Please see your phone owners’ manual for specific instructions on how to drop the Bluetooth connection.
- If the phonebook entry is longer than 24 characters it will be use only the first 24 characters.

Edit Entries in the UConnect™ Phonebook

NOTE: Editing names in the phone book is recommended when vehicle is not in motion.

- Press the “Phone” button to begin.
- After the “Ready” prompt and the following beep, say “Phonebook Edit.”
- You will then be asked for the name of the phone book entry that you wish to edit.
- Next, choose the number designation (home, work, mobile, or pager) that you wish to edit.
- When prompted, recite the new phone number for the phone book entry that you are editing.

After you are finished editing an entry in the phone book, you will be given the opportunities to edit another entry in the phonebook, call the number you just edited, or return to the main menu.

“Phonebook Edit” can be used to add another phone number to a name entry that already exists in the phonebook. For example, the entry John Doe may have a mobile and a home number, but you can add John Doe’s work number later using the “Phonebook Edit” feature.

Delete Entries in the UConnect™ Phonebook

NOTE: Editing phone book entries is recommended when vehicle is not in motion.

- Press the “Phone” button to begin.
- After the “Ready” prompt and the following beep, say “Phonebook Delete.”
- After you enter the Phonebook Delete menu, you will then be asked for the name of the entry that you wish to delete. You can either say the name of a phone book entry that you wish to delete or you can say “List Names” to hear a list of the entries in the phone book from which you choose. To select one of the entries

from the list, press the "Voice Recognition" button while the UConnect™ system is playing the desired entry and say "Delete."

- After you enter the name, the UConnect™ system will ask you which designation you wish to delete, home, work, mobile, pager, or all. Say the designation you wish to delete.
- Note that only the phone book entry in the current language is deleted.

Delete All Entries in the UConnect™ Phonebook

- Press the "Phone" button to begin.
- After the "Ready" prompt and the following beep, say "Phonebook Erase All."
- The UConnect™ system will ask you to verify that you wish to delete all the entries from the phonebook.

- After confirmation, the phone book entries will be deleted.
- Note that only the phone book in the current language is deleted.

List All Names in the UConnect™ Phonebook

- Press the "Phone" button to begin.
- After the "Ready" prompt and the following beep, say "Phonebook List Names."
- The UConnect™ system will play the names of all the phone book entries.
- To call one of the names in the list, press the "Voice Recognition" button during the playing of the desired name, and say "Call."

NOTE: The user can also exercise "Edit" or "Delete" operations at this point.

- The UConnect™ system will then prompt you as to the number designation you wish to call.
- The selected number will be dialed.

Phone Call Features

The following features can be accessed through the UConnect™ system if the feature(s) are available on your cellular service plan. For example, if your cellular service plan provides three-way calling, this feature can be accessed through the UConnect™ system. Check with your cellular service provider for the features that you have.

Answer or Reject an Incoming Call - No Call Currently in Progress

When you receive a call on your cellular phone, the UConnect™ system will interrupt the vehicle audio system, if on, and will ask if you would like to answer the call. Press 'Phone' button to accept the call. To reject the

call, press and hold the 'Phone' button until you hear a single beep indicating that the incoming call was rejected.

Answer or Reject an Incoming Call - Call Currently in Progress

If a call is currently in progress and you have another incoming call, you will hear the same network tones for call waiting that you normally hear when using your cell phone. Press the 'Phone' button to place the current call on hold and answer the incoming call.

NOTE: The UConnect™ system compatible phones in market today do not support rejecting an incoming call when another call is in progress. Therefore, the user can only either answer an incoming call or ignore it.

Making a Second Call while Current Call in Progress

To make a second call while you are currently in a call, press the 'Voice Recognition' button and say "Dial" or "Call" followed by the phone number or phone book

entry you wish to call. The first call will be on hold while the second call is in progress. To go back to the first call, refer to "Toggling Between Calls." To combine two calls, refer to "Conference Call."

Place/Retrieve a Call from Hold

To put a call on hold, press the 'Phone' button until you hear a single beep. This indicates that the call is on hold. To bring the call back from hold, press and hold the "Phone" button until you hear a single beep.

Toggling Between Calls

If two calls are in progress (one active and one on hold), press the "Phone" button until you hear a single beep indicating that the active and hold status of the two calls have switched. Only one call can be placed on hold at one time.

Conference Call

When two calls are in progress (one active and one on hold), press and hold the "Phone" button until you hear a double beep indicating that the two calls have been joined into one conference call.

Three-Way Calling

To initiate three-way calling, press the "Voice Recognition" button while a call is in progress and make a second phone call as described under "Making a Second Call while Current Call in Progress." After the second call has established, press and hold the "Phone" button until you hear a double beep indicating that the two calls have been joined into one conference call.

Call Termination

To end a call in progress, momentarily press the "Phone" button. Only the active call(s) will be terminated and if there is a call on hold, it will become the new active call. If the active call is terminated by the far end, a call on

hold may not become active automatically. This is cell phone dependent. To bring the call back from hold, press and hold the “Phone” button until you hear a single beep.

Redial

- Press the “Phone” button to begin.
- After the “Ready” prompt and the following beep, say “Redial.”
- The UConnect™ system will call the last number that was dialed on your cellular phone.

NOTE: This may not be the last number dialed from the UConnect™ system.

Call Continuation

Call continuation is progression of a phone call on UConnect™ system after the vehicle ignition key has been switched to off. Call continuation functionality available on the vehicle can be any one of three types:

- After ignition key is switched off, a call can continue on the UConnect™ system either until the call ends or until the vehicle battery condition dictates cessation of the call on the UConnect™ system and transfer of the call to the mobile phone.
- After ignition key is switched to off, a call can continue on the UConnect™ system for certain duration, after which the call is automatically transferred from the UConnect™ system to the mobile phone.
- An active call is automatically transferred to the mobile phone after ignition key is switched to off.

UConnect™ System Features

Language Selection

To change the language that the UConnect™ system is using,

- Press the “Phone” button to begin.
- After the “Ready” prompt and the following beep, say the name of the language you wish to switch to (English, Espanol, or Francais, if so equipped).
- Continue to follow the system prompts to complete language selection.

After selecting one of the languages, all prompts and voice commands will be in that language.

NOTE: After every UConnect™ language change operation, only the language specific 32-name phone book is usable. The paired phone name is not language specific and usable across all languages.

Emergency Assistance

If you are in an emergency and the mobile phone is reachable:

- Pick up the phone and manually dial the emergency number for your area.

If the phone is not reachable and the UConnect™ system is operational, you may reach the emergency number as follows:

- Press the “Phone” button to begin.
- After the “Ready” prompt and the following beep, say “Emergency” and the UConnect™ system will instruct the paired cellular phone to call the emergency number. This feature is only supported in the USA.

NOTE: The emergency number dialed is based on the Country where the vehicle is purchased (911 for USA and Canada and 060 for Mexico). The number dialed may not be applicable with the available cellular service and area.

The UConnect™ system does slightly lower your chances of successfully making a phone call as to that for the cell phone directly.

Your phone must be turned on and paired to the UConnect™ system to allow use of this vehicle feature in emergency situations when the cell phone has network coverage and stays paired to the UConnect™ system.

Towing Assistance

If you need towing assistance,

- Press the “Phone” button to begin.
- After the “Ready” prompt and the following beep, say “Towing Assistance.”

NOTE: The Towing Assistance number dialed is based on the Country where the vehicle is purchased (1-800-528-2069 for USA, 1-877-213-4525 for Canada, 55-14-3454 for Mexico City and 1-800-712-3040 for outside Mexico City in Mexico).

Please refer to the 24-Hour “Towing Assistance” coverage details in the Warranty information booklet and on the 24-Hour Towing Assistance Card.

Paging

To learn how to page refer to “Working with Automated Systems.” Paging works properly except for pagers of certain companies which time-out a little too soon to work properly with the UConnect™ system.

Voice Mail Calling

To learn how to access your voice mail, refer to “Working with Automated Systems.”

Working with Automated Systems

This method is designed to be used in instances where one generally has to press numbers on the cellular phone keypad while navigating through an automated telephone system.

You can use your UConnect™ system to access a voice-mail system or an automated service, such as, paging service or automated customer service. Some services require immediate response selection, in some instances, that may be too quick for use of UConnect™ system.

When calling a number with your UConnect™ system that normally requires you to enter in a touch-tone sequence on your cellular phone keypad, you can push the “Voice Recognition” button and say the sequence you wish to enter followed by the word “Send.” For example, if required to enter your pin number followed with a pound 3 7 4 6 #, you can press the “Voice Recognition” button and say “3 7 4 6 # Send.” Saying a number, or sequence of numbers, followed by “Send” is also to be used to navigate through an automated customer service center menu structure and to leave a number on a pager.

You can also send stored UConnect™ phonebook entries as tones for fast and easy access to voicemail and pager

entries. To use this feature, dial the number you wish to call and then press the “Voice Recognition” button and say “Send.” The system will prompt you to enter the name or number, say the name of the phonebook entry you wish to send. The UConnect™ will then send the corresponding phone number associated with the phonebook entry as tones over the phone.

NOTE:

- You may not hear all of the tones due to cellular phone network configurations, this is normal.
- Some paging and voicemail systems have system timeout settings too short that may not allow the use of this feature.

Barge In - Overriding Prompts

The “Voice Recognition” button can be used when you wish to skip part of a prompt and issue your voice recognition command immediately. For example, if a prompt is playing “Would you like to pair a phone, clear

a...," you could press the "Voice Recognition" button and say "Pair a Phone" to select that option without having to listen to the rest of the voice prompt.

Turning Confirmation Prompts On/Off

Turning confirmation prompts off will stop the system from confirming your choices (e.g., the UConnect™ system will not repeat a phone number before you dial it).

- Press the "Phone" button to begin.
- After the "Ready" prompt and the following beep, say "Setup Confirmations." The UConnect™ system will play the current confirmation prompt status and you will be given the choice to change it.

Phone and Network Status Indicators

If available on the radio and/or on a premium display such as the instrument panel cluster, and supported by your cell phone, the UConnect™ system will provide

notification to inform you of your phone and network status when you are attempting to make a phone call using UConnect™. The status is given for roaming, network signal strength, phone battery strength, etc.

Dialing Using the Cellular Phone Keypad

You can dial a phone number with your cellular phone keypad and still use the UConnect™ system (while dialing via the cell phone keypad, the user must exercise caution and take precautionary safety measures). By dialing a number with your paired Bluetooth™ cellular phone, the audio will be played through your vehicle's audio system. The UConnect™ system will work the same as if you dial the number using voice recognition.

NOTE: Certain brands of mobile phones do not send the dial ring to the UConnect™ system to play it on the vehicle audio system, so you will not hear it. Under this situation, after successfully dialing a number, the user

may feel that the call did not go through even though the call is in progress. Once your call is answered, you will hear the audio.

Mute/Un-Mute (Mute Off)

When you mute the UConnect™ system, you will still be able to hear the conversation coming from the other party, but the other party will not be able to hear you. In order to mute the UConnect™ system:

- Press the “Voice Recognition” button.
- Following the beep, say “Mute.”

In order to un-mute the UConnect™ system:

- Press the “Voice Recognition” button.
- Following the beep, say “Mute-off.”

Advanced Phone Connectivity

Transfer Call to and from Cellular Phone

The UConnect™ system allows on going calls to be transferred from your cellular phone to the UConnect™ system without terminating the call. To transfer an ongoing call from your UConnect™ paired cellular phone to the UConnect™ system or vice-versa, press the “Voice Recognition” button and say “Transfer Call.”

Connect or Disconnect Link Between the UConnect™ System and Cellular Phone

Your cellular phone can be paired with many different electronic devices, but can only be actively “connected” with one electronic device at a time.

If you would like to connect or disconnect the Bluetooth™ connection between a UConnect™ paired cellular phone and the UConnect™ system, then follow the instruction described in your cellular phone user’s manual.

List Paired Cellular Phone Names

- Press the “Phone” button to begin.
- After the “Ready” prompt and the following beep, say “Setup Phone Pairing.”
- When prompted, say “List Phones.”
- The UConnect™ system will play the phone names of all paired cellular phones in order from the highest to the lowest priority. To “select” or “delete” a paired phone being announced, press the “Voice Recognition” button and say “Select” or “Delete.” Also, see the next two sections for an alternate way to “select” or “delete” a paired phone.

Select another Cellular Phone

This feature allows you to select and start using another phone with the UConnect™ system. The phone must have been previously paired to the UConnect™ system that you want to use it with.

- Press the “Phone” button to begin.
- After the “Ready” prompt and the following beep, say “Setup Select Phone” and follow the prompts.
- You can also press the “Voice Recognition” button anytime while the list is being played, and then choose the phone that you wish to select.
- The selected phone will be used for the next phone call. If the selected phone is not available, the UConnect™ system will return to using the highest priority phone present in or near (approximately within 30 feet) the vehicle.

Delete UConnect™ Paired Cellular Phones

- Press the “Phone” button to begin.
- After the “Ready” prompt and the following beep, say “Setup Phone Pairing.”

- At the next prompt, say "Delete" and follow the prompts.
- You can also press the "Voice Recognition" button anytime while the list is being played, and then choose the phone you wish to delete.

Things You Should Know About Your UConnect™ System

UConnect™ Tutorial

To hear a brief tutorial of the system features, press the "Phone" button and say "UConnect™ Tutorial."

Voice Training

For users experiencing difficulty with the system recognizing their voice commands or numbers, the UConnect™ system Voice Training feature may be used. To enter this training mode, follow one of the two procedures:

From outside the UConnect™ mode (e.g. from radio mode)

- Press and hold the "Voice Recognition" button for 5 seconds until the session begins, or,
- Press the "Voice Recognition" button and say "Setup, Voice Training" command.

Repeat the words and phrases when prompted by the UConnect™ system. For best results, the Voice Training session should be completed when the vehicle is parked, engine running, all windows closed, and the blower fan switched off.

This procedure may be repeated with a new user. The system will adapt to the last trained voice only.

To restore the Voice Recognition system to factory default settings, enter the Voice Training session via the above procedure and follow the prompts.

Voice Recognition (VR)

- For best performance, adjust the rear view mirror to provide at least ½ inch (1 cm) gap between the overhead console (if equipped) and the mirror.
- Always wait for the beep before speaking.
- Speak normally, without pausing, just as you would speak to a person sitting approximately eight (8) feet away from you.
- Make sure that no one other than you is speaking during a voice recognition period.
- Performance is maximized under:
 - low-to-medium blower setting,
 - low-to-medium vehicle speed,
 - low road noise,
 - smooth road surface,
 - fully closed windows,
 - dry weather condition.
- Even though the system is designed for users speaking in North American English, French, and Spanish accents, the system may not always work for some.
- When navigating through an automated system, such as voice mail, or when sending a page, at the end of speaking the digit string, make sure to say "Send."
- Storing names in phone book when vehicle is not in motion is recommended.
- It is not recommended to store similar sounding names in the UConnect™ phone book.
- UConnect™ phone book nametag recognition rate is optimized for the person who stored the name in the phone book.

- You can say "O" (letter "O") for "0" (zero). "800" must be spoken "eight-zero-zero."
- Even though international dialing for most number combinations is supported, some shortcut dialing number combinations may not be supported.
- In a convertible vehicle, system performance may be compromised with the convertible top down.
- Performance, such as audio clarity, echo, and loudness to a large degree rely on the phone and network, and not the UConnect™ system.
- Echo at far end can sometime be reduced by lowering the in-vehicle audio volume.
- In a convertible vehicle, system performance may be compromised with the convertible top down.

Far End Audio Performance

- Audio quality is maximized under:
 - low-to-medium blower setting,
 - low-to-medium vehicle speed,
 - low road noise,
 - smooth road surface,
 - fully closed windows, and
 - dry weather condition.
- operation from driver seat.

Bluetooth Communication Link

Cellular phones have been found to lose connection to the UConnect™ system. When this happens, the connection can generally be re-established by switching the phone off/on. Your cell phone is recommended to remain in Bluetooth "on" mode.

Power-Up

After switching the ignition key from OFF to either ON or ACC position, or after a language change, you must wait at least five (5) seconds prior to using the system.

Voice Tree

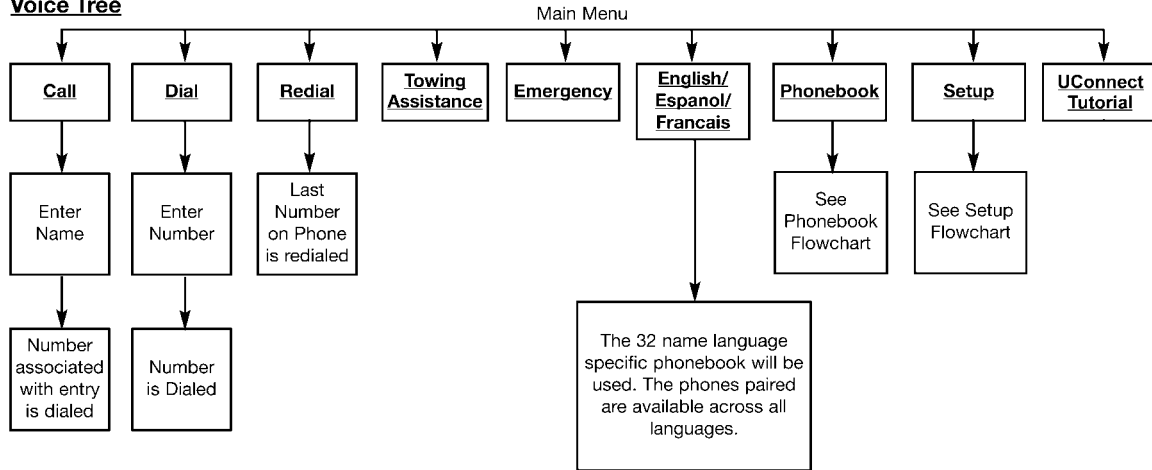

Note: Available Voice commands are shown in bold face and are underlined.

81c6bf7b

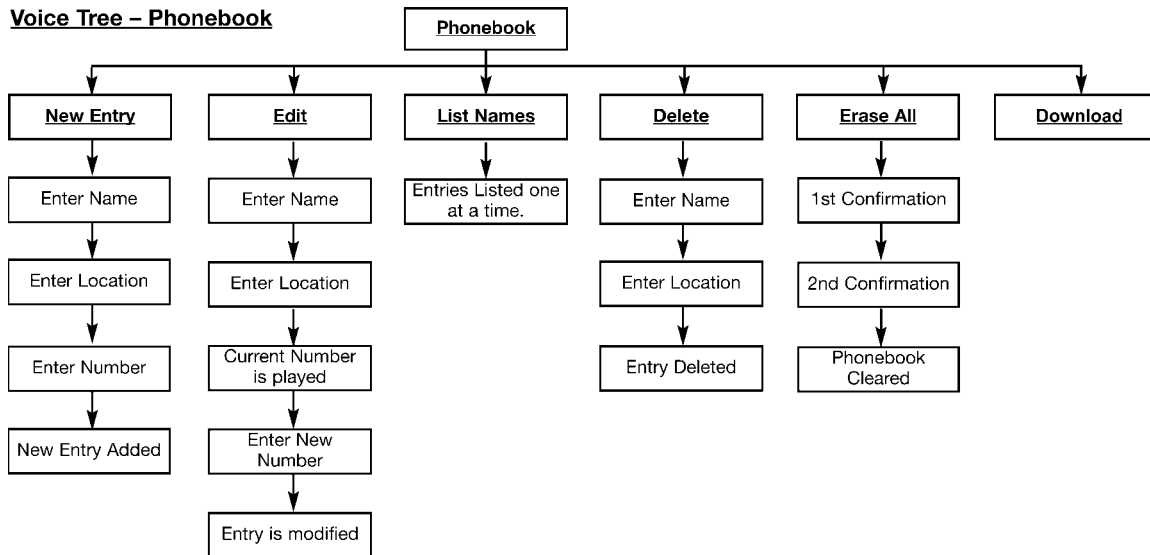
Voice Tree – Phonebook

Note: Available Voice commands are shown in bold face and are underlined.

81c6bf80

Voice Tree – Setup

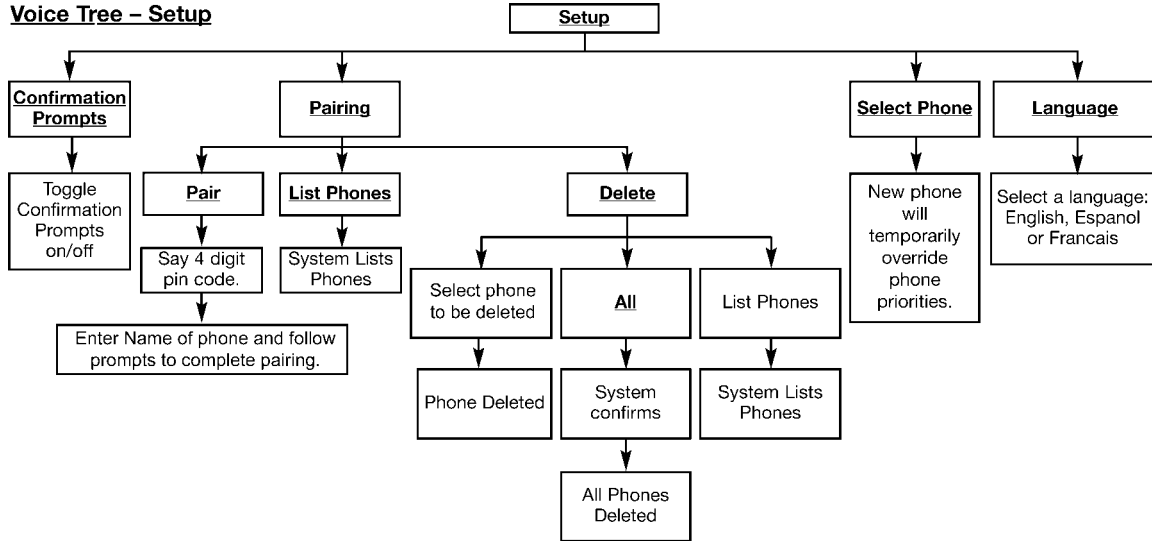

Note: Available Voice commands are shown in bold face and are underlined.

819402e4

Voice Commands	
Primary	Alternate(s)
zero	
one	
two	
three	
four	
five	
six	
seven	
eight	
nine	
star (*)	
plus (+)	
pound (#)	
add location	
all	

Voice Commands	
Primary	Alternate(s)
call	
cancel	
confirmation prompts.	
continue	
delete	
dial	
download	
edit	
emergency	
English	
erase all	
Espanol	
Francais	
help	
home	

Voice Commands	
Primary	Alternate(s)
language	
list names	
list phones	
mobile	
mute	
mute off	
new entry	
no	
pager	
pair a phone	
phone pairing	pairing
phonebook	phone book
previous	
record again	
redial	

Voice Commands	
Primary	Alternate(s)
return to main menu	return or main menu
select phone	select
send	
set up	phone settings or phone set up
towing assistance	
transfer call	
UConnect™ Tutorial	
try again	
voice training	
work	
yes	

General Information

This device complies with part 15 of the FCC rules and RSS 210 of Industry Canada. Operation is subject to the following conditions:

- This device may not cause harmful interference.
- This device must accept any interference received, including interference that may cause undesired operation.

SEATS

Front Manual Seat Adjustment

Move the seat forward or rearward using the adjustment bar. Lift up on the bar located on the front of the seat near the floor. Position the seat and be sure the latch engages fully.

WARNING!

Adjusting a seat while the vehicle is moving is dangerous. The sudden movement of the seat could cause you to lose control. The seat belt might not be properly adjusted and you could be injured. Adjust any seat only while the vehicle is parked.

Front Seat Adjustment — Recline

To adjust the seatback, lift the lever located on the outboard side of the seat, lean back, and release the lever at the desired position. To return the seatback, lift the lever, lean forward, and release the lever.

WARNING!

Do not ride with the seatback reclined so that the seat belt is no longer resting against your chest. In a collision you could slide under the seat belt and be seriously or even fatally injured. Use the recliner only when the vehicle is parked.

WARNING!

- It is extremely dangerous to ride in a cargo area, inside or outside of a vehicle. In a collision, people riding in these areas are more likely to be seriously injured or killed.
- Do not allow people to ride in any area of your vehicle that is not equipped with seats and seat belts.
- Be sure everyone in your vehicle is in a seat and using a seat belt properly.

3

Manual Lumbar Support Adjustment

The manual lumbar support adjustment lever is located on the right side of the driver's seat and on the left side of the passenger's seat (if equipped). Moving the lumbar control lever fore and aft increases or decreases the lumbar support.

8 - Way Driver's Power Seat

The driver's power seat switches are located on the outboard side of the driver's seat lower side trim. The bottom switch controls up/down, forward/rearward, and tilt adjustment. The top switch controls the seatback recline adjustment.

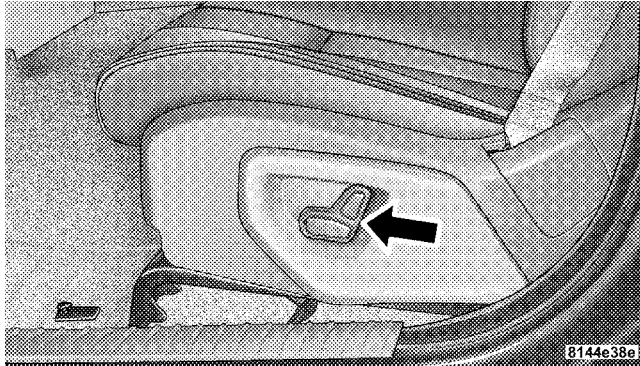

Power Seat Switches

4 - Way Passenger's Power Seat — If Equipped

The front passenger's power seat switches are located on the outboard side of the passenger seat lower side trim. The bottom switch controls forward/rearward adjustment. The top switch controls the seatback recline adjustment.

NOTE: The 4 - way seat does not have an up/down adjustment.

Head Restraints

Head restraints can reduce the risk of whiplash injury in the event of impact from the rear. Adjustable head restraints should be adjusted so that the upper edge is as high as practical. The head restraints have a locking button which must be pushed in to lower the head restraint to all positions. The restraints may be raised without pushing in the button.

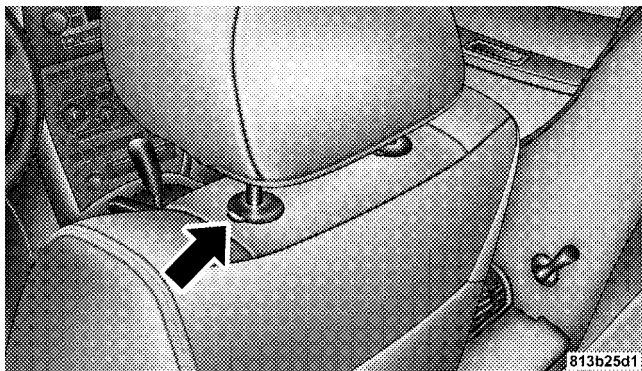

Adjustable Head Restraints

Front Heated Seats—If Equipped

Heated seats provide comfort and warmth on cold days and can help soothe sore muscles and backs. The heaters provide the same heat level for both cushion and back. The front driver and passenger seats are heated. The controls for each heater are located near the bottom

center of the instrument panel. After turning on the ignition, you can choose from High, Low, or Off heat settings. Amber LEDs on the side of each switch indicate the level of heat in use. Two LEDs are illuminated for high, one for low, and none for off. Pressing the switch once will select high-level heating.

3

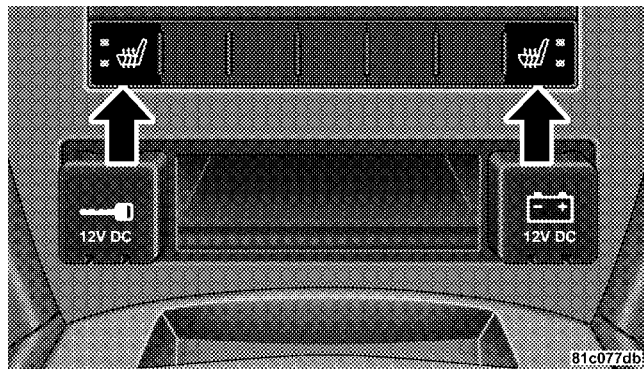

Front Heated Seat Switches

Pressing the switch a second time will select low-level heating. Pressing the switch a third time will shut the heating elements off.

When high-temperature heating is selected, the heaters provide a boosted heat level during the first four minutes of operation after heating is activated. The heat output then drops to the normal high-temperature level. If high-level heating is selected, the system will automatically switch to the low level after 30 minutes of continuous operation. At that time, the number of illuminated LEDs changes from two to one, indicating the change. Operation on the low setting also turns off automatically after 30 minutes.

NOTE: Once a heat setting is selected, heat will be felt within two to five minutes.

WARNING!

Persons who are unable to feel pain to the skin because of advanced age, chronic illness, diabetes, spinal cord injury, medication, alcohol use, exhaustion or other physical condition must exercise care when using the seat heater. It may cause burns even at low temperatures, especially if used for long periods of time.

Do not place anything on the seat that insulates against heat, such as a blanket or cushion. This may cause the seat heater to overheat.

40/20/40 Second Row Folding Seat

Fold and Tumble Second Row Seat

The left, center, or right side of the second row seat can be lowered to allow for extended cargo space, and still maintain some rear seating room.

1. Pull up on the seatback lever located on the outboard side of the seat.

NOTE: Also, pulling upward on this handle allows the outboard seating positions to be reclined.

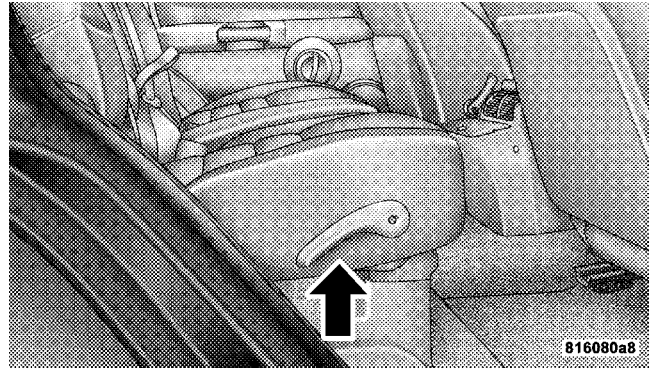

Seatback Release Lever

2. Fold the seatback down, and tumble the seat forward.

WARNING!

Do not drive the vehicle with the outer second row seats in the tumbled position. The outer second row seats are only intended to be tumbled for entry and exit to the third row seat. Failure to follow these instructions could result in personal injury.

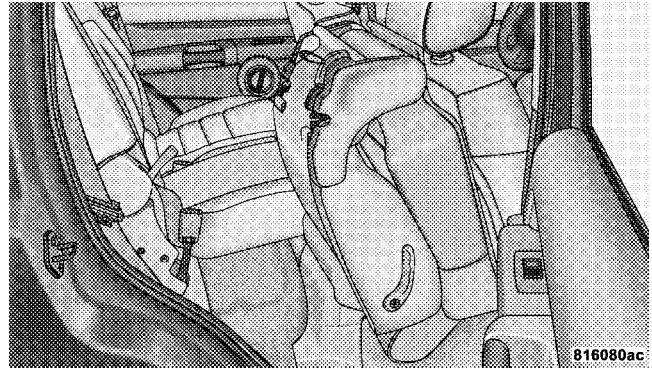

Fold and Tumble Seat

NOTE: If sitting in the third row seat, pull rearward on the release strap located at the rear of the seat and tumble the seat forward.

Folding Middle Seatback (Second Row Seat)

1. Pull the release strap.

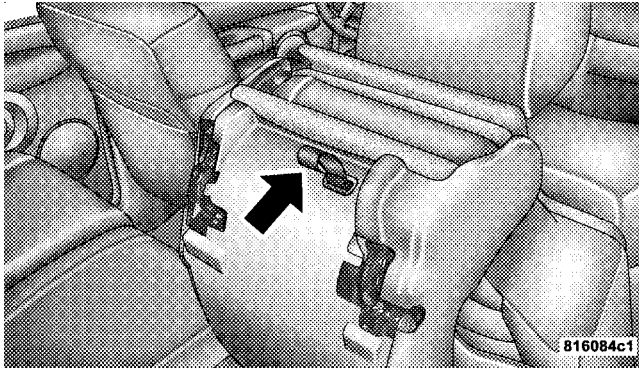

Release Strap

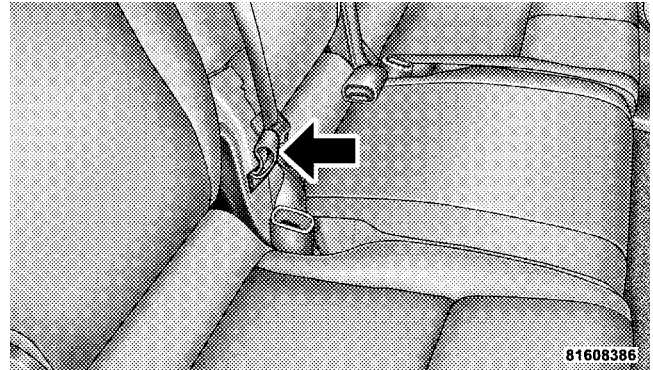

Release Strap

2. Lower the center seatback.

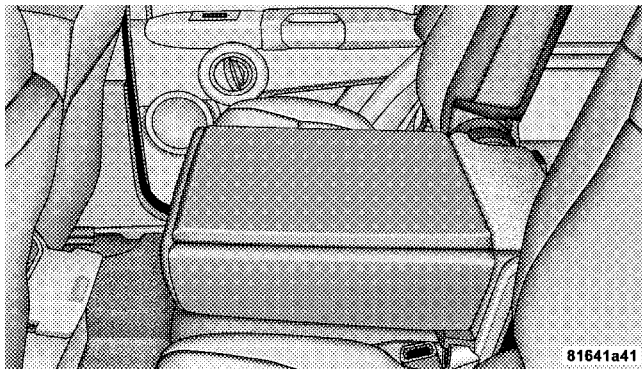

Folding Center Seatback

Center Seat Armrest (Second Row Seat) — If Equipped

The second row center seat may be equipped with an armrest. Pull strap to lower armrest.

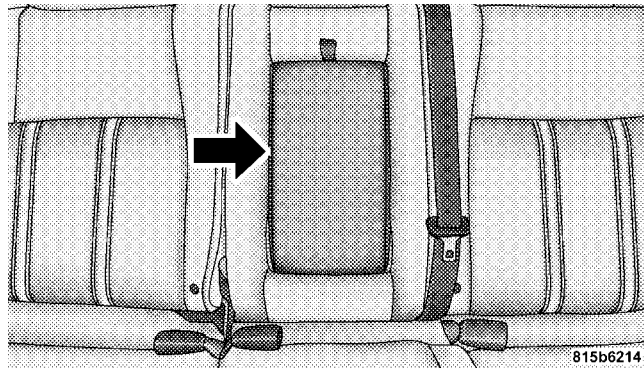

Armrest (Second Row Seat)

50/50 Third Row Folding Seat — If Equipped

To Lower Rear Seat

Either side of the third row seat can be lowered to allow for extended cargo space, and still maintain some rear seating room.

1. Open the tailgate.
2. Push the seatback release handle (toward rear of vehicle), and lower the seatback using the pull strap.

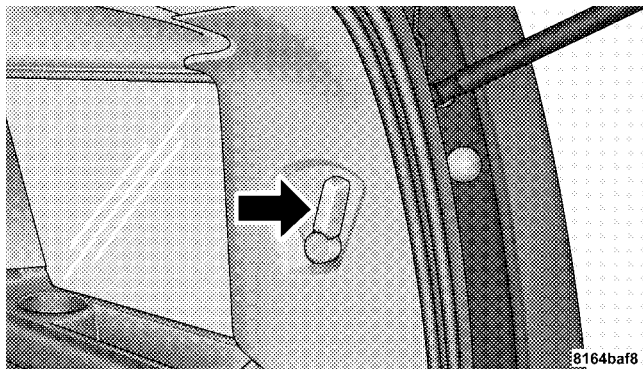

3

Seatback Release Handle

3. Close the tailgate.

To Raise Rear Seat

1. Open the tailgate.
2. Detach pull strap from back of seat, and pull seatback upward until it locks into place. Reattach strap.

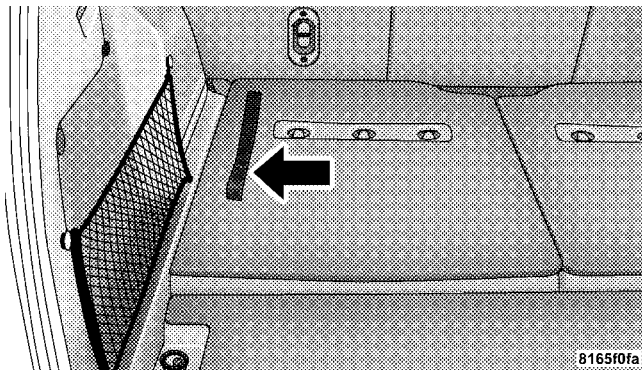

Pull Strap

3. Close the tailgate.

WARNING!

The cargo area in the rear of the vehicle (with the rear seatbacks in the locked-up or folded down position) should not be used as a play area by children when the vehicle is in motion. They could be seriously injured in an accident. Children should be seated and using the proper restraint system.

DRIVER MEMORY SEAT — IF EQUIPPED

Once programmed, the memory buttons 1 and 2 on the driver's door panel can be used to recall the driver's seat, driver's outside mirror, adjustable brake and accelerator pedals, and radio station preset settings. Your Remote Keyless Entry transmitters can also be programmed to recall the same positions when the "Unlock" button is pressed.

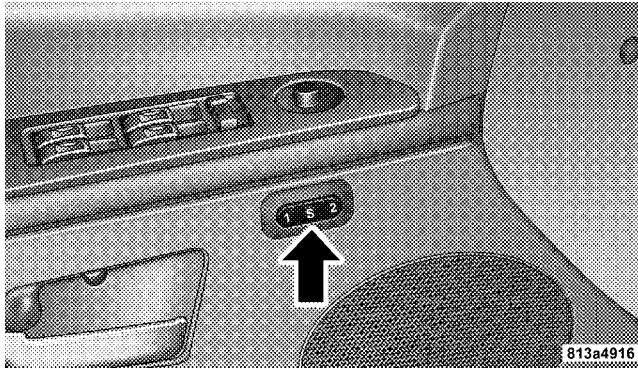

Driver Memory Switches

Your vehicle may have been delivered with two Remote Keyless Entry transmitters. One or both transmitters can be linked to either memory position. The memory system can accommodate up to four transmitters, each one linked to either of the two memory positions.

Setting Memory Positions and Linking Remote Keyless Entry Transmitter to Memory

NOTE: Each time the SET (S) button and a numbered button (1 or 2) are pressed, you erase the memory settings for that button and store a new one.

1. Insert the ignition key and turn the ignition switch to the ON position.
2. Press the driver door memory button number 1 if you are setting the memory for driver 1, or button number 2 if you are setting the memory for driver 2. The system will recall any stored settings. Wait for the system to complete the memory recall before continuing to step 3.
3. Adjust the driver's seat, recliner, and driver's side view mirror to the desired positions.
4. Adjust the brake and accelerator pedals to the desired positions.

5. Turn on the radio and set the radio station presets (up to 10 AM and 10 FM stations can be set).
6. Turn the ignition switch to the OFF position and remove the key.
7. Press and release the SET (S) button located on the driver's door.
8. Within 5 seconds, press and release memory button 1 or 2 on the driver's door. The next step must be performed within 5 seconds if you desire to also use a Remote Keyless Entry transmitter to recall memory positions.
9. Press and release the "Lock" button on one of the transmitters.
10. Insert the ignition key and turn the ignition switch to the ON position.

11. Select "Remote Linked to Memory" in the Electronic Vehicle Information Center (EVIC) and enter "Yes" or select "Use Factory Settings" from the EVIC and enter "Yes". Refer to "Electronic Vehicle Information Center (EVIC) — Customer Programmable Features" in Section 4 for more information.

12. Repeat the above steps to set the next memory position using the other numbered memory button or to link another Remote Keyless Entry transmitter to memory.

Memory Position Recall

NOTE: The vehicle must be in Park to recall memory positions. If a recall is attempted when the vehicle is not in Park, a message will be displayed in the Electronic Vehicle Information Center (EVIC).

To recall the memory settings for driver one, press memory button number 1 on the driver's door or the "Unlock" button on the Remote Keyless Entry transmitter linked to memory position 1.

To recall the memory setting for driver two, press memory button number 2 on the driver's door or the "Unlock" button on the Remote Keyless Entry transmitter linked to memory position 2.

A recall can be cancelled by pressing any of the memory buttons on the drivers door during a recall (S, 1, or 2). When a recall is cancelled, the driver's seat, driver's mirror, and the pedals stop moving. A delay of one second will occur before another recall can be selected.

To Disable A Transmitter Linked to Memory

1. Turn the ignition switch to the OFF position and remove the key.
2. Press and release memory button number 1. The system will recall any memory settings stored in position 1. Wait for the system to complete the memory recall before continuing to step 3.
3. Press and release the memory SET (S) button located on the driver's door.
4. Within 5 seconds, press and release memory button 1 on the driver's door.
5. Within 5 seconds, press and release the "Unlock" button on the Remote Keyless Entry transmitter.

To disable another transmitter linked to either memory position, repeat steps 1-5 for each transmitter.

NOTE: Once programmed, all transmitters linked to memory can be easily enabled or disabled at one time. Refer to Remote Linked to Memory under "Electronic Vehicle Information Center (EVIC) — Customer Programmable Features" in Section 4 for more information.

Easy Entry/Exit Seat

This feature provides automatic driver's seat positioning which will enhance driver mobility out of and into the vehicle.

There are two possible Easy Exit and Easy Entry adjustments available:

- The seat cushion will move rearward approximately 2.5 inches (60 mm) if the starting position of the seat is greater than or equal to 2.67 inches (68 mm) forward of the rear seat stop when the key is removed from the ignition switch. The seat will then move forward

approximately 2.5 inches (60 mm) when the key is placed into the ignition and turned out of the LOCK position.

- The seat shall move to the position located 0.3 inches (8 mm) forward of the rear stop if the starting position is between 0.9 inches to 2.67 inches (23 mm to 68 mm) forward of the rear stop when the key is removed from the ignition switch. The seat will move forward to the memory/driving position when the key is placed into the ignition, and turned out of the LOCK position toward the RUN position.

The Easy Entry/Easy Exit feature will be automatically disabled if the seat is already positioned closer than 0.9 inches (23 mm) forward of the rear stop. At this position there is no benefit to the driver by moving the seat for Easy Exit or Easy Entry.

Each stored memory setting will have an associated Easy Entry and Easy Exit position.

NOTE: The Easy Entry Easy Exit feature is not enabled when the vehicle is delivered from the factory. The Easy Entry Easy Exit feature is enabled (or later disabled) through the programmable features in the Electronic Vehicle Information Center (EVIC). Refer to "Electronic Vehicle Information Center (EVIC) — Customer Programmable Features" in Section 4 for more information.

TO OPEN AND CLOSE THE HOOD

To open the hood, pull the release lever inside your vehicle located below the instrument panel and in front of the driver's door.

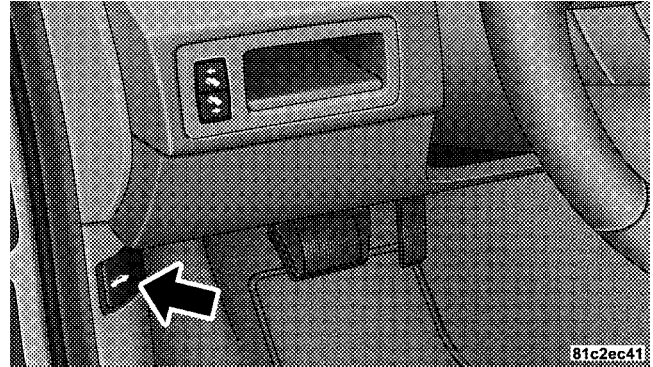

3

Hood Release Handle

124 UNDERSTANDING THE FEATURES OF YOUR VEHICLE

Then, reach under the hood, move safety latch to the left, and lift the hood. To prevent possible damage, do not slam the hood to close it. Use a firm downward push at the center of the hood to ensure that both latches engage.

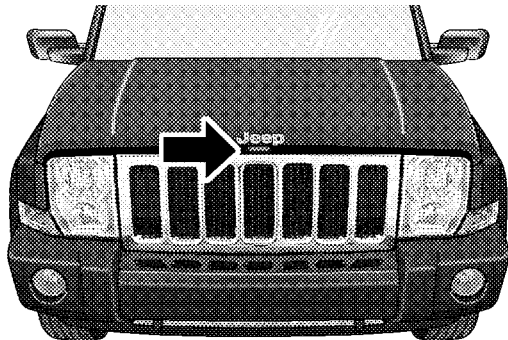

816024a0

Underhood Safety Latch

WARNING!

If the hood is not fully latched, it could fly up when the vehicle is moving and block your forward vision. Be sure all hood latches are fully latched before driving.

LIGHTS

Multi-Function Control Lever

The multi-function control lever controls the operation of the headlights, turn signals, headlight beam selection, instrument panel light dimming, passing light, interior courtesy/dome lights, and optional fog lights.

Battery Saver Feature—Exterior/Interior Lights

If the multi-function control lever is left in the interior light position, parking light position, or the headlight position when the ignition switch is moved to the OFF position, the battery saver feature will automatically turn off the exterior and interior lights after eight minutes. Normal operation will resume when the ignition is turned ON or when the headlight switch is turned to another position.

Headlights and Parking Lights

Turn the end of the multi-function control lever to the first detent for parking light operation. Turn to the second detent for headlight operation. Turn to the third detent for “Auto” headlight operation (if equipped).

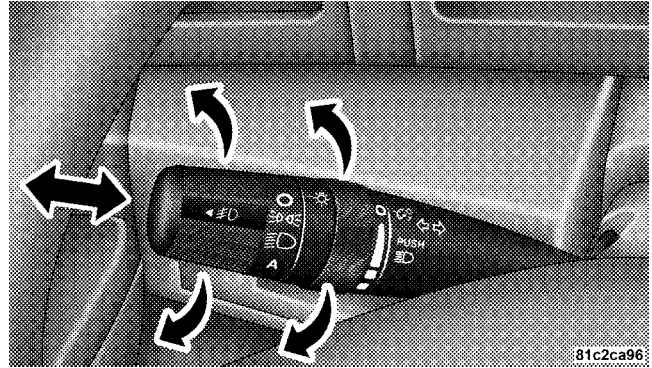

Headlight Switch

Automatic Headlight System — If Equipped

Turn the end of the multi-function control lever to the third detent to activate the automatic headlight system.

This system performs two functions. With the engine running and the multi-function control lever in the A (Auto) position, the headlights will turn on and off based on the surrounding light levels.

Headlights On Automatically With Wipers

If your vehicle is equipped with Automatic Headlights it also has this customer programmable feature. When your headlights are in the automatic mode, and the engine is running, they will automatically turn on when the wiper system is on.

If your vehicle is equipped with a “Rain Sensitive Wiper System,” and it is activated, the headlights will automatically turn on after the wipers complete five wipe cycles within approximately 1 minute, and they will turn off

approximately four minutes after the wipers completely stop. Refer to “Windshield Wipers and Washers” in this section for more information.

NOTE: When your headlights come on during the daytime, the instrument panel lights will automatically dim to the lower nighttime intensity. Refer to “Instrument Panel and Interior Lights” below for setting the instrument panel lights to full daytime intensity.

SmartBeams — If Equipped

The SmartBeam system provides increased forward lighting at night by automating high beam control through the use of a digital camera mounted on the inside rearview mirror. This camera detects vehicle specific light and automatically switches from high beams to low beams until the approaching vehicle is out of view.

NOTE: If the windshield or SmartBeam mirror is replaced, the SmartBeam mirror must be re-aimed to ensure proper performance. See your local authorized dealer.

To Activate

1. Select “Auto Headlamp Low/High Beams? — Low/High Beam.” Refer to “EVIC — Customer Programmable Features” in Section 4 of this manual.
2. Turn the end of the multi-function control lever to the A (Auto) headlight position.

NOTE: This system will not activate until the vehicle is at or above 20 mph (32 km/h).

To Deactivate

1. Pull back on the multi-function control lever to manually deactivate the system (normal operation of high beams).

2. Pull back on the multi-function control lever once again to re-activate the system.

NOTE: Broken, muddy, or obstructed headlights and taillights of vehicles in the field of view will cause headlights to remain on longer (closer to the vehicle). Also, dirt, film, and other obstructions (sticker, toll box, etc.) on the windshield or camera lens will cause the system to function improperly.

Instrument Panel and Interior Lights

When the multi-function control lever is in the parklight, headlight, or A (Auto) position (if equipped), rotating the center portion of the lever up and down will increase and decrease the brightness (dimmer control) of the instrument panel lights. Full daytime brightness on all electronic displays (odometer, overhead console, radio, and Automatic Climate Control (if equipped)) is obtained by rotating the center portion of the control to the first detent above the dimmer range. Rotating the control to

the second detent above the dimmer range turns the interior lights on. Rotating the control to the “Off” (extreme bottom) position disables all the interior lights, even when the doors and liftgate are open. While in the “Off” position the instrument panel lighting is at the lowest light level and may not be suitable for night driving.

Daytime Running Lights — If Equipped

The high beam headlights come on at a low intensity level whenever the engine is running, and the transmission is not in the P (Park) position. The lights remain on until the ignition switch is turned OFF or the parking brake is engaged. The headlight switch must be used for normal night time driving.

Lights-On Reminder

If the headlights or parking lights are on after the ignition is turned OFF, a chime will sound when the driver’s door is opened.

Fog Lights — If Equipped

#0 The fog light switch is located in the multi-function control lever. To activate the fog lights, turn on the park/turn lights, low beam headlights, or “Auto” headlights and pull out the end of the multi-function control lever. A light in the instrument cluster shows when the fog lights are on.

NOTE: Turning on the high beam headlights turns off the fog lights.

A front fog light is a lighting device providing illumination forward of the vehicle under conditions of fog, rain, snow, or dust. Principally, the front fog light supplements the lower beam of a standard headlight system.

NOTE: Proper aim and adjustments of the front fog lights should be made to prevent excessive glare for other drivers.

Turn Signals

Move the multi-function control lever up or down and the arrows on each side of the instrument cluster will flash to show proper operation of the front and rear turn signal lights. You can signal a lane change by moving the lever partially up or down.

Turn Signal Auto-Mode

Tap the multi-function control lever once and the turn signal (left or right) will flash 3 times, and automatically turn off.

High Beam Switch

Push the multi-function control lever away from you to switch the headlights to high beam. Pull the lever towards you to switch the headlights back to low beam.

Passing Light

You can signal another vehicle with your headlights by lightly pulling the multi-function control lever toward the steering wheel. This will cause the headlights to turn on at high beam and remain on until the lever is released.

Headlight Time Delay

There is also a feature that delays turning off the vehicle lights for 30, 60, or 90 seconds after the ignition switch is turned OFF. To activate the headlight delay, the multi-function control lever must be rotated to the “Off” position after the ignition switch is turned OFF. Only the headlights will illuminate during this time. Refer to “EVIC- Customer Programmable Features” in Section 4 to turn this feature “On/Off” or set the time interval.

Interior Lights

The interior lighting consists of courtesy lights mounted below the instrument panel, an overhead console light assembly which contains both driver and passenger reading lights, reading lights located above the rear doors, and a rear cargo light. Opening a door or turning the center of the multi-function control lever to the extreme up position will activate all interior courtesy lights.

Courtesy/Reading Lights

Each light can be turned on by pressing the recessed area of the lens. To turn these lights off, press the recessed area of the lens a second time. There are also reading lights located above the rear doors. Each light can be turned on by pressing the front recessed area of the lens. To turn these lights off, press the recessed area of the lens a second time.

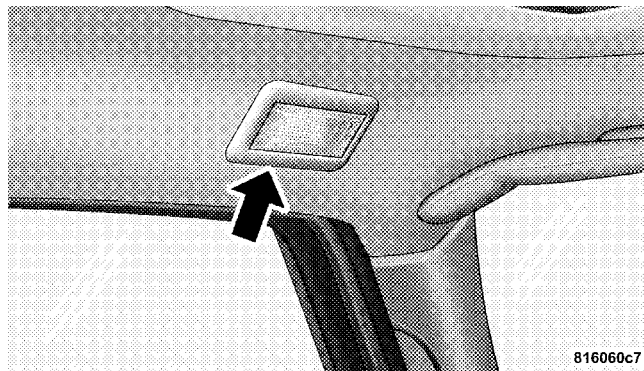

Courtesy/Reading Lights

WINDSHIELD WIPERS AND WASHERS

The front and rear wipers and washers are operated by a switch in the right side control lever. Turn the end of the control lever to select “Lo,” “Hi,” or one of the five speed sensitive intermittent windshield wiper speeds. Refer to “Speed Sensitive Intermittent Wiper System” in this section. For information on the rear wiper and washer refer to “Rear Window Features” in this section.

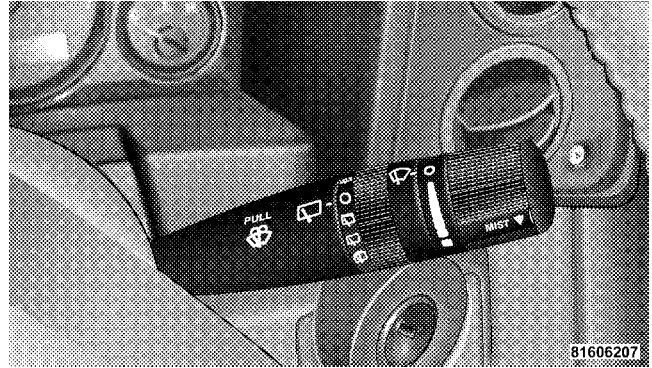

3

Windshield Wiper/Washer Switch

NOTE: Always remove any build-up of snow that prevents the windshield wiper blades from returning to the OFF position. If the windshield wiper switch is turned off and the blades cannot return to the OFF position, damage to the wiper motor may occur.

To use the washer, pull the lever toward you and hold while spray is desired. If the lever is pulled while in the delay range, the wiper will operate for several seconds after the lever is released, and then resume the intermittent interval previously selected.

If the lever is pulled while in the OFF position, the wipers will operate for several wipe cycles, then turn off.

WARNING!

Sudden loss of visibility through the windshield could lead to an accident. You might not see other vehicles or other obstacles. To avoid sudden icing of the windshield during freezing weather, warm the windshield with the defroster before and during windshield washer use.

Mist

Use this feature when weather conditions make occasional usage of the wipers necessary. Pull down and release the control lever for a single wiping cycle.

Speed Sensitive Intermittent Wiper System

Use one of the five intermittent wiper speeds when weather conditions make a single wiping cycle, with a variable pause between cycles, desirable. Turn the end of the lever to one of the five delay positions for the desired delay interval. The delay can be regulated from a maximum of approximately 18 seconds between cycles, to a cycle every 1/2 second.

NOTE: The wiper delay times depend on vehicle speed. If the vehicle is moving less than 10 mph (16 km/h), delay times will be doubled.

Rain Sensing Wipers—If Equipped

This feature senses moisture on the windshield and automatically activates the wipers for the driver. The feature is especially useful for road splash or overspray from the windshield washers of the vehicle ahead. Rotate the end of the multi-function lever to one of five settings to activate this feature.

The sensitivity of the system can be adjusted with the multi-function lever. Wiper delay position 1 is the least sensitive, and wiper delay position 5 is the most sensitive. Setting 3 should be used for normal rain conditions. Settings 1 and 2 can be used if the driver desires less wiper sensitivity. Settings 4 and 5 can be used if the driver desires more sensitivity. Place the wiper switch in the OFF position when not using the system.

NOTE:

- The rain sensing feature will not operate when the wiper switch is in the LOW or HIGH speed position.

- The rain sensing feature may not function properly when ice, or dried salt water is present on the windshield.
- Use of Rain-X® or products containing wax or silicone may reduce rain sensor performance.
- A customer programmable feature in the Electronic Vehicle Information Center (EVIC) allows the Rain Sense feature to be turned off. Refer to “Electronic Vehicle Information Center (EVIC) — Customer Programmable Features” in Section 4 of this manual.

The rain sensing system has protection features for the wiper blades and arms, and will not operate under the following conditions:

- **Low Ambient Temperature** — When the ignition is first turned ON, the rain sensing system will not operate until the wiper switch is moved, vehicle speed is greater than 0 mph (0 km/h), or the outside temperature is greater than 32°F (0°C).

- **Transmission in N (Neutral) Position** — When the ignition is ON, and the transmission is in the N (Neutral) position, the rain sensing system will not operate until the wiper switch is moved, vehicle speed is greater than 5 mph (8 km/h), or the shift lever is moved out of the N (Neutral) position.

TILT/TELESCOPING STEERING COLUMN

This feature allows you to tilt the steering column upward or downward. It also allows you to lengthen or shorten the steering column. The tilt/telescoping control handle is located below the steering wheel at the end of the steering column.

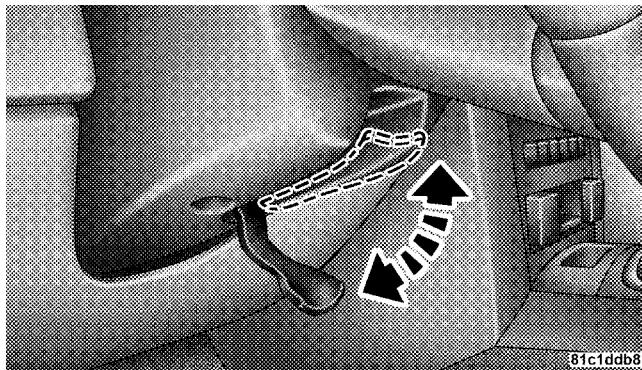

Tilt Steering Column

To unlock the steering column, push the control handle downward (toward the floor). To tilt the steering column, move the steering wheel upward or downward as desired. To lengthen or shorten the steering column, pull the steering wheel outward or push it inward as desired. To lock the steering column in position, push the control handle upward until fully engaged.

WARNING!

Do not adjust the steering wheel while driving. The telescoping adjustment must be locked while driving. Adjusting the steering wheel while driving or driving without the telescoping adjustment locked could cause the driver to lose control of the vehicle.

ADJUSTABLE PEDALS — IF EQUIPPED

This feature allows both the brake and accelerator pedals to move toward the driver to provide improved position with the steering wheel. The adjustable pedal system is designed to allow a greater range of driver comfort for steering wheel tilt and seat position. The position of the brake and accelerator pedals can be adjusted without compromising safety or comfort in actuating the pedals.

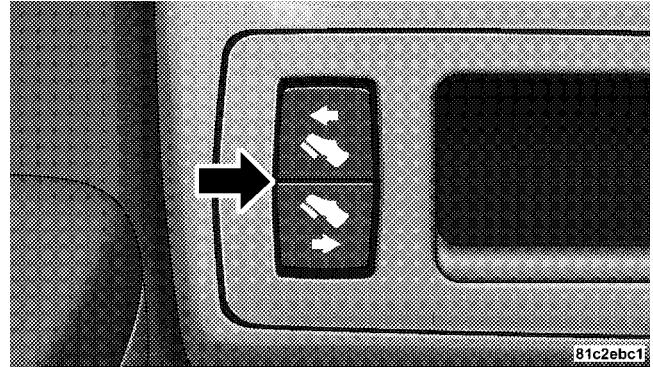

3

Adjustable Pedal Switch

Press the bottom of the switch to move the pedals rearward (toward the driver).

Press the top of the switch to move the pedals forward (away from the driver).

- The pedals can be adjusted with the ignition OFF.
- The pedals can be adjusted while driving.
- The pedals **cannot** be adjusted when the vehicle is in R (Reverse) or when the Speed Control is ON. A message will be displayed in the Electronic Vehicle Information Center (EVIC) if the pedals are attempted to be adjusted when the system is locked out (“Adjustable Pedal Disabled — Cruise Control Engaged” or “Adjustable Pedal Disabled — Vehicle In Reverse”). Refer to Electronic Vehicle Information Center (EVIC) in Section 4 for more information.

CAUTION!

Do not place any article under the adjustable pedal's or impede its ability to move as it may cause damage to the pedal controls. Pedal travel may become limited if movement is stopped by an obstruction in the adjustable pedal's path.

ELECTRONIC SPEED CONTROL — IF EQUIPPED

When engaged, this device takes over accelerator operations at speeds greater than 30 mph (48 km/h) for 3.7L/4.7L engines, and 25 mph (40 km/h) for 5.7L engines.

Electronic Speed Control Operation

The speed control lever is located on the right side of the steering wheel.

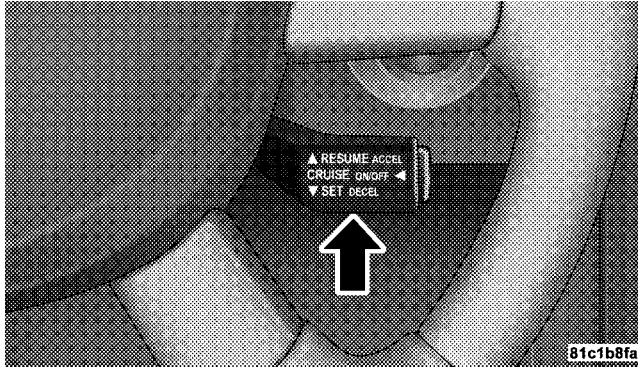

Electronic Speed Control Switch

To Activate

Push the ON/OFF button. The CRUISE indicator in the instrument cluster will illuminate. To turn the system OFF, push the ON/OFF button a second time. The CRUISE indicator will turn off. The system should be turned OFF when not in use.

WARNING!

Leaving the Speed Control system on when not in use is dangerous. You could accidentally set the system or cause it to go faster than you want. You could lose control and have an accident. Always leave the system OFF when you are not using it.

3

To Set At A Desired Speed

When the vehicle has reached the desired speed, press down on the lever and release. Release the accelerator and the vehicle will operate at the selected speed.

NOTE: The vehicle should be traveling at a steady speed and on level ground before pressing the SET lever.

To Deactivate

A soft tap on the brake pedal, pulling the speed control lever towards you “CANCEL”, or normal brake or clutch pressure while slowing the vehicle will deactivate speed control without erasing the set speed memory. Pressing the ON/OFF button or turning off the ignition switch erases the set speed memory.

To Resume Speed

To resume a previously set speed, push the “RESUME ACCEL” lever up and release. Resume can be used at any speed above 30 mph (48 km/h) for 3.7L/4.7L engines, and 25 mph (40 km/h) for 5.7L engines.

To Vary The Speed Setting

When the speed control is ON, speed can be increased by pushing up and holding “RESUME ACCEL”. Release the lever when the desired speed is reached, and the new speed will be set.

Tapping “RESUME ACCEL” once will result in a 2 mph (3 km/h) (3.7L/4.7L models) or a 1 mph (2 km/h) (5.7L models) speed increase. Each time the lever is tapped, speed increases so that tapping the lever three times will increase speed by 6 mph (10 km/h) (3.7L/4.7L models) or 3 mph (5 km/h) (5.7L models).

To decrease speed while speed control is ON, push down and hold “SET DECEL”. Release the lever when the desired speed is reached, and the new speed will be set.

Tapping the “SET DECEL” button once will result in a 1 mph (2 km/h) speed decrease. Each time the button is tapped, speed decreases.

NOTE: The Speed Control system has been designed to shut down if multiple speed control switch functions are operated simultaneously in order to ensure proper operation. If this occurs, the system can be reactivated by pushing the speed control switch ON/OFF button and re-setting the desired vehicle SET speed.

To Accelerate For Passing

Depress the accelerator as you would normally. When the pedal is released, the vehicle will return to the set speed.

Using Speed Control On Hills

The automatic transmission may downshift on hills to maintain the vehicle set speed.

NOTE: The speed control system maintains speed up and down hills. A slight speed change on moderate hills is normal.

On steep hills a greater speed loss or gain may occur so it may be preferable to drive without speed control.

ELECTRONIC BRAKE CONTROL SYSTEM

Your vehicle is equipped with an advanced electronic brake control system that includes ABS (Anti-Lock Brake System), TCS (Traction Control System), BAS (Brake Assist System), ERM (Electronic Roll Mitigation), and ESP (Electronic Stability Program). All five of these systems work together to enhance vehicle stability and control in various driving conditions.

Also, your vehicle is equipped with TSC (Trailer Sway Control) and, if it has 4WD with the NV245 two-speed transfer case, HSA (Hill Start Assist) and HDC (Hill Descent Control).

ABS (Anti-Lock Brake System)

This system aids the driver in maintaining vehicle control under adverse braking conditions. The system controls hydraulic brake pressure to prevent wheel lock-up and

help avoid skidding on slippery surfaces during braking. Refer to “Anti-Lock Brake System” in Section 5 of this manual for more information about ABS.

WARNING!

ABS (Anti-Lock Brake System) cannot prevent the natural laws of physics from acting on the vehicle, nor can it increase the traction afforded by prevailing road conditions. ABS cannot prevent accidents, including those resulting from excessive speed in turns, driving on very slippery surfaces, or hydroplaning. Only a safe, attentive, and skillful driver can prevent accidents. The capabilities of an ABS-equipped vehicle must never be exploited in a reckless or dangerous manner which could jeopardize the user’s safety or the safety of others.

TCS (Traction Control System)

This system monitors the amount of wheel spin of each of the driven wheels. If wheel spin is detected, brake pressure is applied to the slipping wheel(s) and engine power is reduced to provide enhanced acceleration and stability. A feature of the TCS system functions similar to a limited slip differential and controls the wheel spin across a driven axle. If one wheel on a driven axle is spinning faster than the other, the system will apply the brake of the spinning wheel. This will allow more engine torque to be applied to the wheel that is not spinning. This feature remains active even if TCS and ESP are in either the “Partial Off” or “Full Off” modes. Refer to “ESP (Electronic Stability Program)” in this section for more information.

BAS (Brake Assist System)

The BAS is designed to optimize the vehicle's braking capability during emergency braking maneuvers. The system detects an emergency braking situation by sensing the rate and amount of brake application and then applies optimum pressure to the brakes. This can help reduce braking distances. The BAS complements the anti-lock brake system (ABS). Applying the brakes very quickly results in the best BAS assistance. To receive the benefit of the system, you must apply **continuous** braking pressure during the stopping sequence (do not "pump" the brakes). Do not reduce brake pedal pressure unless braking is no longer desired. Once the brake pedal is released, the BAS is deactivated.

WARNING!

BAS (Brake Assist System) cannot prevent the natural laws of physics from acting on the vehicle, nor can it increase the traction afforded by prevailing road conditions. BAS cannot prevent accidents, including those resulting from excessive speed in turns, driving on very slippery surfaces, or hydroplaning. Only a safe, attentive, and skillful driver can prevent accidents. The capabilities of a BAS-equipped vehicle must never be exploited in a reckless or dangerous manner which could jeopardize the user's safety or the safety of others.

ERM (Electronic Roll Mitigation)

This system anticipates the potential for wheel lift by monitoring the driver's steering wheel input and the speed of the vehicle. When ERM determines that the rate of change of the steering wheel angle and vehicles speed are sufficient to potentially cause wheel lift, it then applies the brake of the appropriate wheel and may also reduce engine power to lessen the chance that wheel lift will occur. ERM will only intervene during very severe or evasive driving maneuvers.

ERM can only reduce the chance of wheel lift occurring during severe or evasive driving maneuvers. It cannot prevent wheel lift due to other factors such as road conditions, leaving the roadway or striking objects or other vehicles.

NOTE: Anytime the ESP system is in the "Full Off" mode, ERM is disabled. Refer to ESP (Electronic Stability Program) for a complete explanation of the available ESP modes.

WARNING!

Many factors, such as vehicle loading, road conditions and driving conditions, influence the chance that wheel lift or rollover may occur. ERM cannot prevent all wheel lift or rollovers, especially those that involve leaving the roadway or striking objects or other vehicles. Only a safe, attentive, and skillful driver can prevent accidents. The capabilities of an ERM-equipped vehicle must never be exploited in a reckless or dangerous manner which could jeopardize the user's safety or the safety of others.

ESP (Electronic Stability Program)

This system enhances directional control and stability of the vehicle under various driving conditions. ESP corrects for oversteering or understeering of the vehicle by applying the brake of the appropriate wheel to assist in counteracting the oversteer or understeer condition. Engine power may also be reduced to help the vehicle maintain the desired path.

ESP uses sensors in the vehicle to determine the vehicle path intended by the driver and compares it to the actual path of the vehicle. When the actual path does not match the intended path, ESP applies the brake of the appropriate wheel to assist in counteracting the oversteer or understeer condition.

- Oversteer - when the vehicle is turning more than appropriate for the steering wheel position.
- Understeer - when the vehicle is turning less than appropriate for the steering wheel position.

The "ESP/TCS Indicator Light" located in the instrument cluster, starts to flash as soon as the tires lose traction and the ESP system becomes active. The "ESP/TCS Indicator Light" also flashes when TCS is active. If the "ESP/TCS Indicator Light" begins to flash during acceleration, ease up on the accelerator and apply as little throttle as possible. Be sure to adapt your speed and driving to the prevailing road conditions.

WARNING!

ESP (Electronic Stability Program) cannot prevent the natural laws of physics from acting on the vehicle, nor can it increase the traction afforded by prevailing road conditions. ESP cannot prevent accidents, including those resulting from excessive speed in turns, driving on very slippery surfaces, or hydroplaning. Only a safe, attentive, and skillful driver can prevent accidents. The capabilities of an ESP-equipped vehicle must never be exploited in a reckless or dangerous manner which could jeopardize the user's safety or the safety of others.

The ESP system has 3 available operating modes in 4WD High Range, 2 available operating modes on 2WD vehicles, and 1 operating mode in 4WD Low Range.

High Range (4WD Models) or 2WD Models***On***

This is the normal operating mode for ESP in 4WD high range and in 2WD vehicles. Whenever the vehicle is started or the transfer case (if equipped) is shifted from 4WD low range or neutral back to 4WD high range, the ESP system will be in this "On" mode. This mode should be used for most driving situations. ESP should only be turned to "Partial Off" or "Full Off" mode for specific reasons as noted below.

Partial Off

This mode is entered by momentarily depressing the "ESP OFF" switch. When in "Partial Off" mode, the TCS portion of ESP, except for the "limited slip" feature described in the TCS section, has been disabled and the "ESP/TCS Indicator Light" will be illuminated. All other stability features of ESP function normally. This mode is intended to be used if the vehicle is in deep snow, sand,

or gravel conditions and more wheel spin than ESP would normally allow is required to gain traction. To turn ESP on again, momentarily depress the "ESP OFF" switch. This will restore the normal "ESP On" mode of operation.

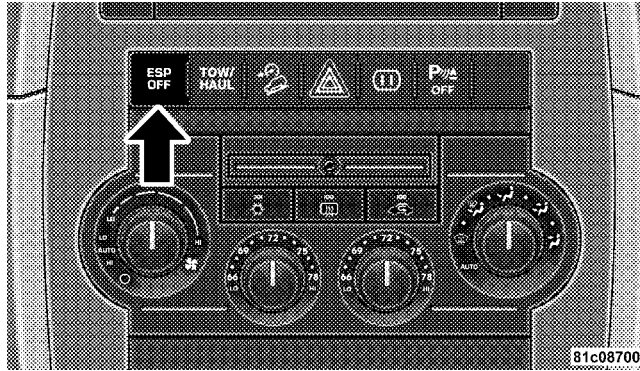

ESP OFF Switch

NOTE: To improve the vehicle's traction when driving with snow chains, or starting off in deep snow, sand, or gravel, it may be desirable to switch to the "Partial Off" mode by pressing the ESP switch. Once the situation requiring ESP to be switched to the "Partial Off" mode is overcome, turn ESP back on by momentarily depressing the "ESP OFF" switch. This may be done while the vehicle is in motion.

Full Off (4WD Models Only)

This mode is intended for off-highway or off-road use when ESP stability features could inhibit vehicle maneuverability due to trail conditions. This mode is entered by depressing and holding the "ESP OFF" switch for 5 seconds when the vehicle is stopped and the engine is running. After 5 seconds, the "ESP/TCS Indicator Light" will illuminate, and the "ESP OFF" message will appear in the Electronic Vehicle Information Center (EVIC). Refer to "Electronic Vehicle Information Center (EVIC)" in Section 4 of this manual for more information.

In this mode, ESP and TCS, except for the “limited slip” feature described in the TCS section, are turned off until the vehicle reaches a speed of 40 mph (64 km/h). At 40 mph (64 km/h) the system returns to “Partial Off” mode, described above. When the vehicle speed drops below 35 mph (56 km/h) the ESP system shuts off. ESP is deactivated at low vehicle speeds so that it will not interfere with off-road driving but ESP function returns to provide the stability feature at speeds above 40 mph (64 km/h). The “ESP/TCS Indicator Light” will always be illuminated when ESP is off. To turn ESP on again, momentarily depress the “ESP OFF” switch. This will restore the normal “ESP On” mode of operation.

NOTE: The “ESP OFF” message will display and the audible chime will sound when the gear selector is placed into the “P” (Park) position from any other position, and then moved out of the “P” (Park) position. This will occur even if the message was previously cleared.

WARNING!

With the ESP switched off, the enhanced vehicle stability offered by ESP and ERM are unavailable. In an emergency evasive maneuver, the ESP and ERM systems will not engage to assist in maintaining stability. The “Full Off” ESP mode is intended for off-road use only.

4WD Low Range

Full Off

This is the normal operating mode for ESP in 4WD low range. Whenever the vehicle is started in 4WD low range, or the transfer case (if equipped) is shifted from 4WD high range or neutral to 4WD low range, the ESP system will be in this “Full Off” mode. In 4WD low range, ESP and TCS, except for the “limited slip” feature described in the TCS section, are turned off until the vehicle reaches

a speed of 40 mph (64 km/h). At 40 mph (64 km/h), the normal ESP stability function returns but TCS remains off. When the vehicle speed drops below 35 mph (56 km/h), the ESP system shuts off. ESP is deactivated at low vehicle speeds in 4WD low range so that it will not interfere with off-road driving but ESP function returns to provide the stability feature at speeds above 40 mph (64 km/h). The "ESP/TCS Indicator Light" will always be illuminated in 4WD low range when ESP is off.

NOTE: The "ESP OFF" message will display and the audible chime will sound when the gear selector is placed into the "P" (Park) position from any other position, and then moved out of the "P" (Park) position. This will occur even if the message was previously cleared

WARNING!

With the ESP switched off, the enhanced vehicle stability offered by ESP and ERM are unavailable. In an emergency evasive maneuver, the ESP and ERM systems will not engage to assist in maintaining stability. The "Full Off" mode is intended for off-road use only.

3

TSC (Trailer Sway Control)

TSC uses sensors in the vehicle to recognize an excessively swaying trailer and will take the appropriate actions to attempt to stop the sway. The system may reduce engine power and apply the brake of the appropriate wheel(s) to counteract the sway of the trailer. TSC will become active automatically once an excessively swaying trailer is recognized. No driver action is required. Note that TSC cannot stop all trailers from

swaying. Always use caution when towing a trailer and follow the tongue weight recommendations. Refer to “Trailer Towing” in Section 5 of this manual for more information on towing a trailer with your vehicle. When TSC is functioning, the “ESP/TCS Indicator Light” will flash, the engine power may be reduced and you may feel the brakes being applied to individual wheels to attempt to stop the trailer from swaying. TSC is disabled when the ESP system is in the Partial Off or Full Off modes.

WARNING!

If TSC activates while driving, slow the vehicle down, stop at the nearest safe location, and adjust the trailer load to eliminate trailer sway.

HSA (Hill Start Assist) (4WD Models with NV245 Two-Speed Transfer Case Only)

The HSA system is designed to assist the driver when starting a vehicle from a stop on a hill. HSA will maintain the level of brake pressure the driver applied for a short period of time after the driver takes their foot off of the brake pedal. If the driver does not apply the throttle during this short period of time, the system will release brake pressure and the vehicle will roll down the hill. The system will release brake pressure in proportion to amount of throttle applied as the vehicle starts to move in the intended direction of travel.

HSA Activation Criteria

The following criteria must be met in order for HSA to activate:

- Vehicle must be stopped.
- Vehicle must be on a 8% grade or greater hill.
- Gear selection matches vehicle uphill direction (i.e., vehicle facing uphill is in forward gear; vehicle backing uphill is in R (Reverse) gear).

HSA will work in R (Reverse) and all forward gears when the activation criteria have been met. The system will not activate if the vehicle is placed in N (Neutral) or P (Park).

WARNING!

There may be situations on minor hills (i.e., less than 8%), with a loaded vehicle, or while pulling a trailer, when the system will not activate and slight rolling may occur. This could cause a collision with another vehicle or object. Always remember the driver is responsible for braking the vehicle.

3

Towing with HSA

HSA will provide assistance when starting on a grade when pulling a trailer.

WARNING!

- **If you use a trailer brake controller with your trailer, your trailer brakes may be activated and deactivated with the brake switch. If so, when the brake pedal is released there may not be enough brake pressure to hold the vehicle and trailer on a hill and this could cause a collision with another vehicle or object behind you. In order to avoid rolling down the hill while resuming acceleration, manually activate the trailer brake prior to releasing the brake pedal. Always remember the driver is responsible for braking the vehicle.**
- **HSA is not a parking brake. If you stop the vehicle on a hill without putting the transmission in P (Park) and using the parking brake, it will roll down the hill and could cause a collision with another vehicle or object. Always remember to use the parking brake while parking on a hill, and that the driver is responsible for braking the vehicle.**

HSA Off

If you wish to turn off the HSA system, it can be done using the Customer Programmable Features in the Electronic Vehicle Information Center (EVIC). Refer to “Electronic Vehicle Information Center (EVIC)” in Section 4 of this manual.

HDC (Hill Descent Control) (4WD Models with NV245 Two-Speed Transfer Case Only)

HDC maintains vehicle speed while descending hills during off-road driving situations and is available in 4 LOW range only. To enable HDC (transfer case must be in 4 LOW range), press the HDC switch. If the HDC switch is pressed when the vehicle is not in 4 LOW range, the light in the switch will flash for 5 seconds and HDC will not be enabled.

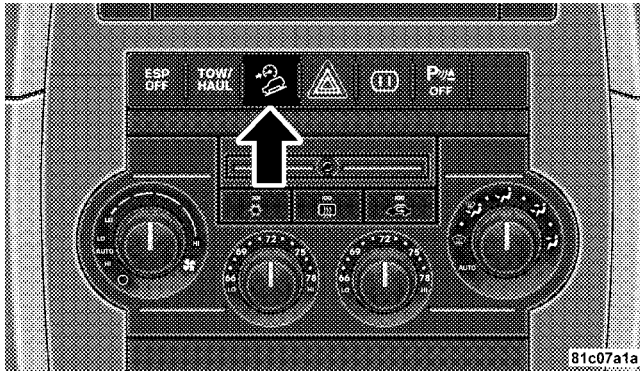

Hill Descent Switch

When HDC is enabled properly, the message “HILL DESCENT CONTROL” will appear in the EVIC and the light in the switch will be illuminated. HDC will automatically apply the brakes to control downhill speed when necessary. HDC has the capability to sense terrain

and will only activate when the vehicle is descending a hill. It will usually not activate on level ground.

The HDC speed may be adjusted by the driver to suit the driving conditions. The speed corresponds to the transmission gear selected.

- 1st = 1 mph (1.6 km/h)
- 2nd = 2.5 mph (4 km/h)
- 3rd = 4 mph (6 km/h)
- 4th = 5.5 mph (9 km/h)
- 5th = 7.5 mph (12 km/h)
- Reverse (R) = 1 mph (1.6 km/h)
- Neutral (N) = 2.5 mph (4 km/h)
- Park (P) — HDC will not function

HDC also has the capability to sense rough terrain, and will automatically adjust to a slightly slower set speed (about .3 mph (.5 km/h) than normal.

HDC operation can be overridden with brake application to slow the vehicle down below the HDC control speed. Conversely, if more speed is desired during HDC control, the accelerator pedal will increase vehicle speed in the usual manner. When either the brake or the accelerator is released, HDC will control the vehicle back to the original set speed.

HDC is intended for low speed off-road driving only. At vehicle speeds above 30 mph (48 km/h), HDC will no longer function. When the vehicle speed drops below 30 mph (48 km/h), HDC function will automatically resume and the vehicle speed will return to the chosen set speed.

WARNING!

HDC is only intended to assist the driver in controlling vehicle speed when descending hills. The driver must remain attentive to the driving conditions and is responsible for maintaining a safe vehicle speed.

ESP/BAS Warning Lamp and ESP/TCS Indicator Light

**ESP
BAS**

The malfunction indicator lamp for the ESP is combined with the BAS indicator. The yellow “ESP/BAS Warning Lamp” and the yellow “ESP/TCS Indicator Light” in the instrument cluster both come on when the ignition switch is turned to the “ON” position. They should both go out with the engine running.



If the “ESP/BAS Warning Lamp” comes on continuously with the engine running, a malfunction has been detected in either the ESP or the BAS system, or both. If this light remains on after several ignition cycles, and the vehicle has been driven several miles at speeds greater than 30 mph (48 km/h), see your authorized dealer as soon as possible to have the problem diagnosed and corrected.

NOTE:

- “The “ESP/TCS Indicator Light” and the “ESP/BAS Warning Lamp” come on **momentarily** each time the ignition switch is turned ON.
- Each time the ignition is turned ON, the ESP System will be ON even if it was turned off previously.
- The ESP Control System will make buzzing or clicking sounds when it is active. This is normal; the sounds will stop when ESP becomes inactive following the maneuver that caused the ESP activation.

REAR PARK ASSIST SYSTEM— IF EQUIPPED

The Rear Park Assist System provides visual and audible indications of the distance between the rear fascia and the detected obstacle when backing up. Refer to the Warning Section and Note Section for limitations of this system and recommendations.

The Rear Park Assist System will remember the last system state (enabled or disabled) from the last ignition cycle when the ignition is changed to the RUN/ON position.

The Rear Park Assist System can be active only when the shifter is in R (Reverse). If the Rear Park Assist System is enabled at this shifter position, the system will be active until the vehicle speed is increased to approximately 11 mph (18 km/h) or above. The system will be active again if the vehicle speed is decreased to speeds less than approximately 10 mph (16 km/h).

Rear Park Assist Sensors

The four Rear Park Assist Sensors, located in the rear fascia, monitor the area behind the vehicle that is within the sensors' field of view. The monitored area seems oval in shape.

The sensors can detect obstacles from approximately 11.8 inches (30 cm) up to 59 inches (150 cm) from the rear fascia in the horizontal direction, depending on the location and orientation of the obstacle and the type of obstacle.

Rear Park Assist Warning Display

The Rear Park Assist Warning Display, located in the headliner near the flipper glass, provides both visual and audible warnings to indicate the distance between the rear fascia and the detected obstacle.

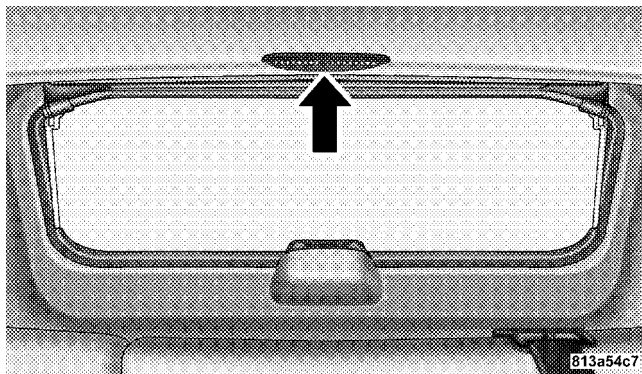

Rear Park Assist Display

When the ignition is changed to the RUN/ON position, the warning display will turn ON all of its LEDs for about 1 second. Each side of the warning display has 6 yellow and 2 red LEDs. The vehicle is close to the obstacle when the red LED is ON.

The system dimly illuminates the two outer most yellow LED's when it is ON and detecting no obstacles. The following chart shows the warning display operation when the system is detecting an obstacle:

WARNING DISPLAY DISTANCES

DISPLAY LED	OBSTACLE DISTANCE FROM:		LED COLOR	AUDIBLE SIGNAL
	REAR CORNERS	REAR CENTER		
1st LED		59 in. (150 cm)	Yellow	None
2nd LED		51 in. (130 cm)	Yellow	None
3rd LED		45 in. (115 cm)	Yellow	None
4th LED	31.5 in. (80 cm)	39 in. (100 cm)	Yellow	None
5th LED	25.5 in. (65 cm)	33.5 in. (85 cm)	Yellow	None
6th LED	20 in. (50 cm)	28 in. (70 cm)	Yellow	None
7th LED	16 in. (40 cm)	20 in. (50 cm)	Red	Yes, Intermittent
8th LED	6 in. (15 cm)	12 in. (30 cm)	Red	Yes, Continuous

NOTE: The Rear Park Assist system will MUTE the radio, if on, when the system is sounding an audio tone.

Enable/Disable the Rear Park Assist System

The Rear Park Assist System can be enabled and disabled with a switch located on the upper switch bank of the instrument panel.

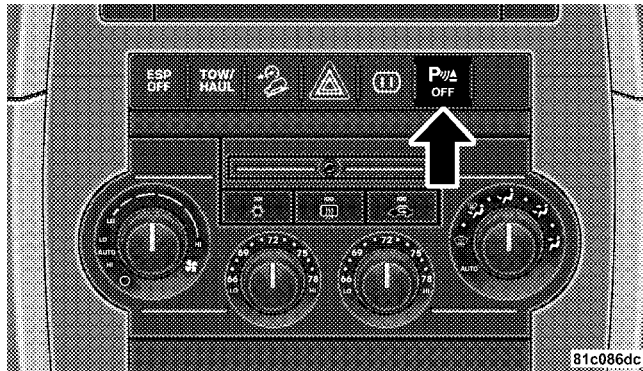

Rear Park Assist Switch

When the switch is pressed to disable the system, the instrument cluster will display the "PARK ASSIST DISABLED" message. Refer to "Electronic Vehicle Information Center (EVIC)" in Section 4 of this manual. When the shifter is changed to R (Reverse) and the system is disabled, the instrument cluster will actuate a single chime, once per ignition cycle, and it will display the message.

The Rear Park Assist Switch LED will be ON when the Rear Park Assist System is disabled or defective. The Rear Park Assist Switch LED will be OFF when the system is enabled.

Service the Rear Park Assist System

When the Rear Park Assist System is defective, the instrument cluster will actuate a single chime, once per ignition cycle, and it will display the "SERVICE PARK ASSIST SYSTEM" message. Refer to "Electronic Vehicle Information Center (EVIC)" in Section 4 of this manual.

Cleaning the Rear Park Assist System

Clean the Rear Park Assist Sensors with water, car wash soap and a soft cloth. Do not use rough or hard cloths. Do not scratch or poke the sensors. Otherwise, you could damage the sensors.

REAR CAMERA — IF EQUIPPED

Vehicles with a Navigation radio may be equipped with a rear view camera (located on the rear liftgate) that allows you to see an on-screen image (on the navigation radio screen) of the rear of your vehicle whenever the vehicle is put into R (Reverse).

WARNING!

Drivers must be careful when backing up even when using the rear camera system. Always check carefully behind your vehicle, and be sure to check for pedestrians, animals, other vehicles, obstructions, or blind spots before backing up. Failure to do so can result in serious injury or death.

3

If snow, ice, mud, or anything else builds up on the camera lens. Clean the lens, rinse with water, and dry with a soft cloth.

Turning the Rear Camera On

1. To access the rear camera mode, select “Rear Camera” at the Systems Settings screen and press ENTER. Refer to your “Navigation User’s Manual” for detailed operating instructions.

2. Select “ON” at the “Rear Camera” screen. Highlight “DONE” and press ENTER. The rear camera is now enabled.
3. When the vehicle is shifted into R (Reverse), the CAUTION screen will appear, followed by an image of the rear of the vehicle.
4. When the vehicle is shifted out of R (Reverse), the rear camera mode is exited and the Navigation or Audio screen appears again.

Turning the Rear Camera Off

1. To turn the rear camera off, select “Rear Camera” at the Systems Settings screen and press ENTER. Refer to your “Navigation User’s Manual” for detailed operating instructions.
2. Select “OFF” at the “Rear Camera” screen. Highlight “DONE” and press ENTER. The rear camera is now disabled.

OVERHEAD CONSOLE — IF EQUIPPED

The overhead console contains an optional universal garage door opener (HomeLink®), storage for sunglasses, and optional power sunroof switches.

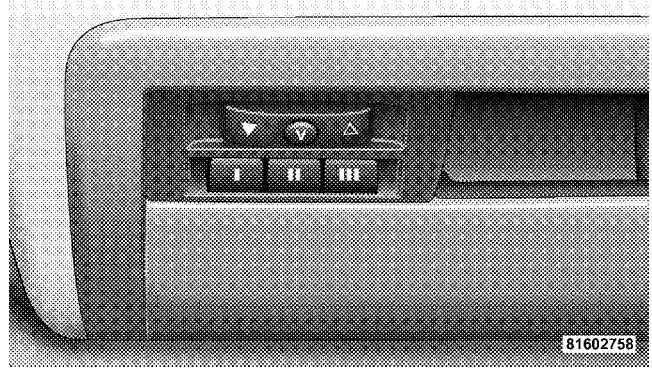

Overhead Console

GARAGE DOOR OPENER — IF EQUIPPED

HomeLink® replaces up to three remote controls (hand held transmitters) that operate devices such as garage door openers, motorized gates, lighting, or home security systems. The HomeLink® unit operates off of your vehicle's battery.

NOTE: HomeLink® is disabled when the Vehicle Security Alarm is active.

WARNING!

Your motorized door or gate will open and close while you are training the Universal Transceiver. Do not train the transceiver if people or pets are in the path of the door or gate. Only use this transceiver with a garage door opener that has a “stop and reverse” feature as required by federal safety standards. This includes most garage door opener models manufactured after 1982. Do not use a garage door opener without these safety features. Call toll-free 1-800-355-3515 or, on the Internet at www.HomeLink.com for safety information or assistance.

WARNING!

Vehicle exhaust contains carbon monoxide, a dangerous gas. Do not run your vehicle in the garage while training the transceiver. Exhaust gas can cause serious injury or death.

Programming HomeLink®**Before You Begin**

If you have not trained any of the HomeLink® buttons, erase all channels before you begin training.

To do this, press and hold the two outside buttons for 20 seconds. The EVIC will display “CLEARING CHANNELS.” Release the buttons when the EVIC message states “CHANNELS CLEARED.”

It is recommended that a new battery be placed in the hand-held transmitter of the device being programmed to HomeLink® for more efficient training and accurate transmission of the radio-frequency signal.

Your vehicle should be parked outside of the garage while training.

1. Turn the ignition switch to the ON/RUN position.
2. Place the hand-held transmitter 1–3 inches (3–8 cm) from the HomeLink® buttons while keeping the EVIC display in view.

For optimal training, point the battery end of the hand-held transmitter away from the HomeLink®.

3. Simultaneously press and hold both the chosen HomeLink® button and the hand-held transmitter button until the EVIC display changes from “CHANNEL # TRAINING” to “CHANNEL # TRAINED.”

Then release both the HomeLink® and hand-held transmitter buttons.

If the EVIC display states “DID NOT TRAIN” repeat Step 3. If the signal is too weak, replace the battery in the original hand-held transmitter.

It may take up to 30 seconds, or longer in rare cases. The garage door may open & close while you train.

NOTE: Some gate operators and garage door openers may require you to replace Step #3 with procedures noted in the “Gate Operator/Canadian Programming” section.

4. Press and hold the just-trained HomeLink® button. If the channel has been trained, the EVIC display will now state “CHANNEL # TRANSMIT.”

If the EVIC display still states “CHANNEL # TRAINING” repeat Step 3.

NOTE: After training a HomeLink® channel, if the garage door does not operate with HomeLink® and the garage door opener was manufactured after 1995, the garage door opener may have rolling code. If so, proceed to the heading “Programming A Rolling Code System.”

5. PROGRAMMING A ROLLING CODE SYSTEM

At the garage door opener motor (in the garage), locate the “learn” or “training” button.

162 UNDERSTANDING THE FEATURES OF YOUR VEHICLE

This can usually be found where the hanging antenna wire is attached to the garage door opener motor (it is NOT the button normally used to open & close the door).

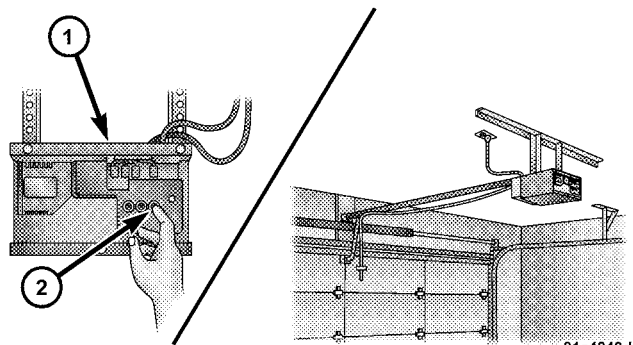

- 1 — Garage Door Opener
2 — Training Button

6. Firmly press and release the “learn” or “training” button. The name and color of the button may vary by manufacturer.

NOTE: There are 30 seconds in which to initiate the next step after the “Learn” button has been pressed.

7. Return to the vehicle and press the programmed HomeLink® button twice (holding the button for 2 seconds each time). If the device is plugged in and activates, programming is complete.

If the device does not activate, press the button a third time (for 2 seconds) to complete the training.

If you have any problems, or require assistance, please call toll-free 1-800-355-3515 or, on the Internet at www.HomeLink.com for information or assistance.

To program the remaining two HomeLink® buttons, repeat each step for each remaining button. DO NOT erase the channels.

Gate Operator/Canadian Programming

Canadian radio-frequency laws require transmitter signals to “time-out” (or quit) after several seconds of transmission – which may not be long enough for HomeLink® to pick up the signal during programming. Similar to this Canadian law, some U.S. gate operators are designed to “time-out” in the same manner.

It may be helpful to unplug the device during the cycling process to prevent possible overheating of the garage door or gate motor.

If you are having difficulties programming a garage door opener or a gate operator, replace “Programming HomeLink” Step 3 with the following:

3. Continue to press and hold the HomeLink® button while you press and release - every two seconds (“cycle”) your hand-held transmitter until HomeLink®

has successfully accepted the frequency signal. The EVIC display will change from “CHANNEL # TRAINING” to “CHANNEL # TRAINED.”

If you unplugged the device for training, plug it back in at this time.

Then proceed with Step 4 under “Programming HomeLink.” earlier in this section.

Using HomeLink®

To operate, simply press and release the programmed HomeLink® button. Activation will now occur for the trained device (i.e. garage door opener, gate operator, security system, entry door lock, home/office lighting, etc. The hand-held transmitter of the device may also be used at any time.

Reprogramming a Single HomeLink® Button

To re-program a channel that has been previously trained, follow these steps:

1. Turn the ignition switch to the ON/RUN position.
2. Press and hold the desired HomeLink® button for 20 seconds until the EVIC display states “CHANNEL # TRAINING.” **Do not release the button.**
3. **Without releasing the button**, proceed with PROGRAMMING HOMELINK Step #2 and follow all remaining steps.

Security

It is advised to erase all channels before you sell or turn in your vehicle.

To do this, press and hold the two outside buttons for 20 seconds until the EVIC message states “CHANNELS CLEARED.” Note that all channels will be erased. Individual channels cannot be erased.

The HomeLink® Universal Transceiver is disabled when the Vehicle Security Alarm is active.

Troubleshooting Tips

If you are having trouble programming HomeLink®, here are some of the most common solutions:

- Replace the battery in the original transmitter.
- Press the Learn Button on the Garage Door Opener to complete the training for Rolling Code.
- Did you unplug the device for training, and remember to plug it back in?

If you have any problems, or require assistance, please call toll-free 1-800-355-3515 or, on the Internet at www.HomeLink.com for information or assistance.

General Information

This device complies with FCC rules part 15 and Industry Canada RSS-210. Operation is subject to the following two conditions:

1. This device may not cause harmful interference
2. This device must accept any interference that may be received including interference that may cause undesired operation

NOTE: The transmitter has been tested and it complies with FCC and IC rules. Changes or modifications not expressly approved by the party responsible for compliance could void the user's authority to operate the device.

The term "IC:" before the certification/registration number only signifies that Industry Canada technical specifications were met.

POWER SUNROOF — IF EQUIPPED

The power sunroof switch is located on the overhead console.

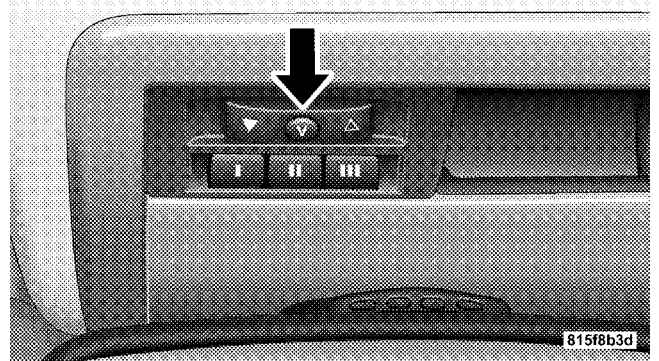

Power Sunroof Switch

WARNING!

- **Never leave children in a vehicle, with the keys in the ignition switch. Occupants, particularly unattended children, can become entrapped by the power sunroof while operating the power sunroof switch. Such entrapment may result in serious injury or death.**
- **In an accident, there is a greater risk of being thrown from a vehicle with an open sunroof. You could also be seriously injured or killed. Always fasten your seat belt properly and make sure all passengers are properly secured too.**
- **Do not allow small children to operate the sunroof. Never allow fingers or other body parts, or any object to project through the sunroof opening. Injury may result.**

Opening Sunroof - Express

Press the switch rearward and release, and the sunroof will open automatically from any position. The sunroof will open fully, then stop automatically. This is called Express Open. During Express Open operation, any movement of the sunroof switch will stop the sunroof.

Closing Sunroof - Express

Press the switch forward and release, and the sunroof will close automatically from any position. The sunroof will close fully and stop automatically. This is called Express Close. During Express Close operation, any movement of the switch will stop the sunroof.

Pinch Protect Feature

This feature will detect an obstruction in the opening of the sunroof during Express Close operation. If an obstruction in the path of the sunroof is detected, the

sunroof will automatically retract. Remove the obstruction if this occurs. Next, press the switch forward and release to Express Close.

Pinch Protect Override

If a known obstruction (ice, debris, etc.) prevents closing, press the switch forward and hold for two seconds after the reversal occurs. This allows the sunroof to move towards the closed position.

NOTE: Pinch protection is disabled while the switch is pressed.

Venting Sunroof - Express

Press and release the "V" button, and the sunroof will open to the vent position. This is called Express Vent, and will occur regardless of sunroof position. During Express Vent operation, any movement of the switch will stop the sunroof.

Sunshade Operation

The sunshade can be opened manually. However, the sunshade will open automatically as the sunroof opens.

NOTE: The sunshade cannot be closed if the sunroof is open.

Wind Buffeting

Wind buffeting can be described as the perception of pressure on the ears or a helicopter type sound in the ears. Your vehicle may exhibit wind buffeting with the windows down, or the sunroof (if equipped) in certain open or partially open positions. This is a normal occurrence and can be minimized. If the buffeting occurs with the rear windows open, open the front and rear windows together to minimize the buffeting. If the buffeting occurs with the sunroof open, adjust the sunroof opening to minimize the buffeting or open any window.

Sunroof Maintenance

Use only a non-abrasive cleaner and a soft cloth to clean the glass panel.

Ignition Off Operation

The power sunroof switches remain active for 10 minutes after the ignition switch has been turned off. Opening either front door will cancel this feature.

Sunroof Fully Closed

Press the switch forward and release to ensure that the sunroof is fully closed.

COMMAND-VIEW™ SKYLIGHTS — IF EQUIPPED

The two fixed skylights are above the second row seats. The glass is tinted to shield the second row occupants from the sun and glare. Each skylight includes a roller shade that is concealed in the assembly to block out more light when desired.

NOTE: Hold onto shade handle until shade is completely open or closed.

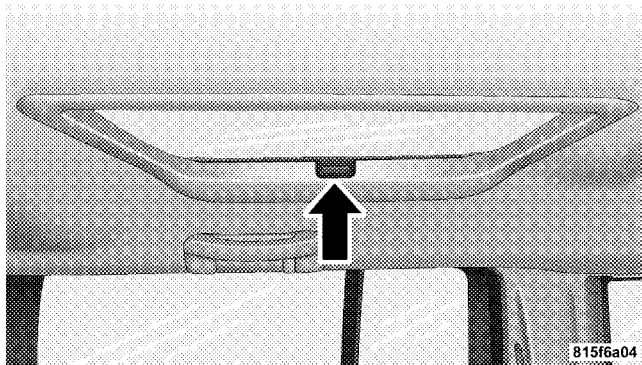

Roller Shade

POWER OUTLET

Front Power Outlet

To the left and right of the convenience tray (lower center of instrument panel) is an outlet for electrically powered accessories. Pull lightly on the tab of the plastic cover to access the outlet.

Rear Power Outlet — If Equipped

The rear power outlet (if equipped) is located in the left rear cargo area.

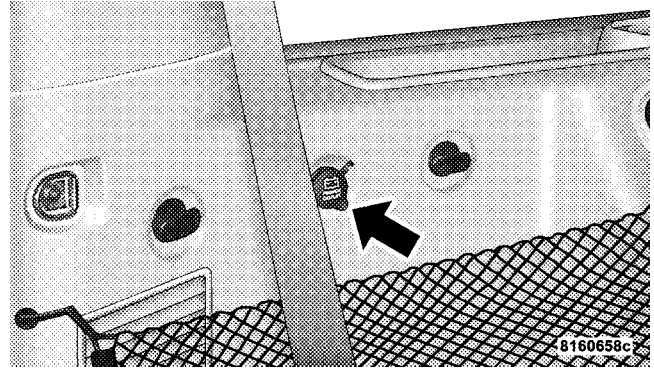

Rear Power Outlet

All accessories connected to this outlet should be removed or turned off when the vehicle is not in use to protect the battery against discharge.

CAUTION!**Electrical Outlet Use With Engine Off**

- Many accessories that can be plugged in draw power from the vehicle's battery, even when not in use (i.e., cellular phones, etc.). Eventually, if plugged in long enough, the vehicle's battery will discharge sufficiently to degrade battery life and/or prevent engine starting.
- Accessories that draw higher power (i.e., coolers, vacuum cleaners, lights, etc.) will degrade the battery even more quickly. Only use these intermittently and with greater caution.
- After the use of high power draw accessories, or long periods of the vehicle not being started (with accessories still plugged in), the vehicle must be driven a sufficient length of time to allow the generator to recharge the vehicle's battery.

POWER INVERTER — IF EQUIPPED

There is a 110-volt, 150-watt inverter outlet located on the back of the center console to convert DC current to AC current. This outlet can be used to power small appliances and electronics.

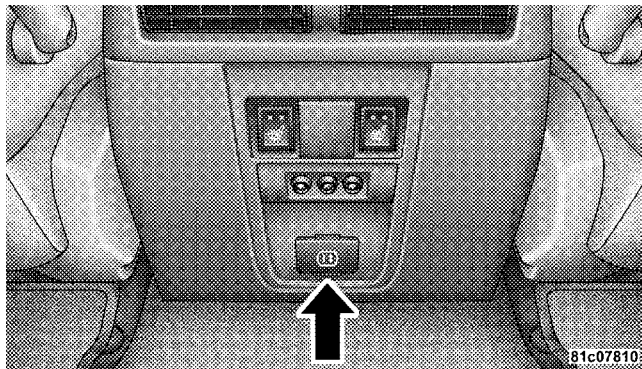
**Power Inverter**

Press the power inverter switch (located on the upper switch bank) to turn the power on to the outlet. Press the switch again to turn the power off.

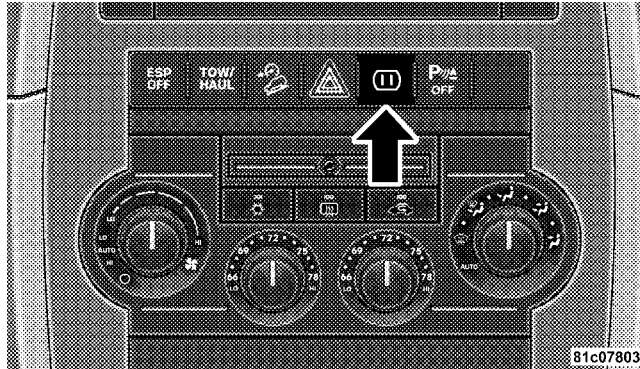

Power Inverter Switch

NOTE: When the power inverter switch is pressed, there will be a delay of approximately 1 second before the

inverter status indicator turns ON. The status indicator of the AC power inverter indicates whether the inverter is producing AC power.

NOTE: Due to built in overload protection, the inverter will shut down if the power rating is exceeded.

3

WARNING!

To Avoid Serious Injury or Death:

- Do not use a 3—Prong Adaptor.
- Do not insert any objects into the receptacles.
- Do not touch with wet hands.
- Close the lid when not in use.
- If this outlet is mishandled it may cause an electric shock and failure.

CUP HOLDERS

Front Cup Holders

In the center console, there are two cup holders for the front seat passengers.

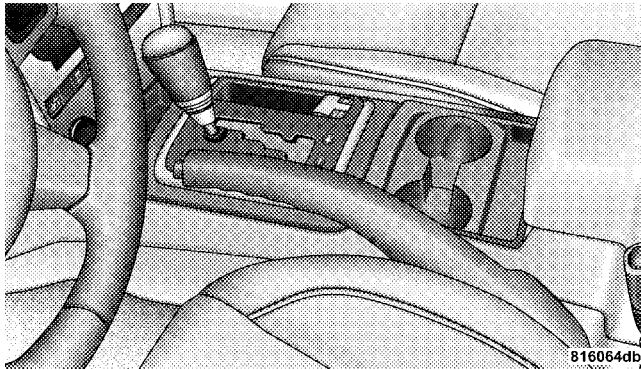

Front Cup Holders

NOTE: The cup holder insert is removable, from the console, for cleaning. It can be reinstalled with the larger cup depression towards the passenger seat, but the top surface will not be flush with the console surface.

Cup Holders (Second Row Seat)

The second row seat has two cup holders in the center armrest. Lower the center armrest. Refer to “Seats” in this section. Press the front of the cup holder, and the cup holder will come out of the armrest.

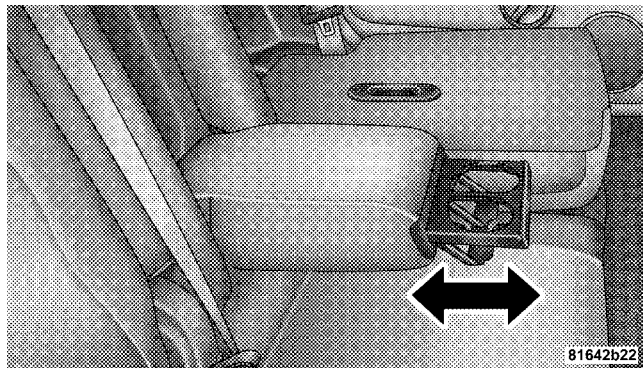

Cup Holders (Second Row Seat)

Cup Holders (Third Row Seat)

The third row seat passengers have cup holders on the left and right rear trim panels.

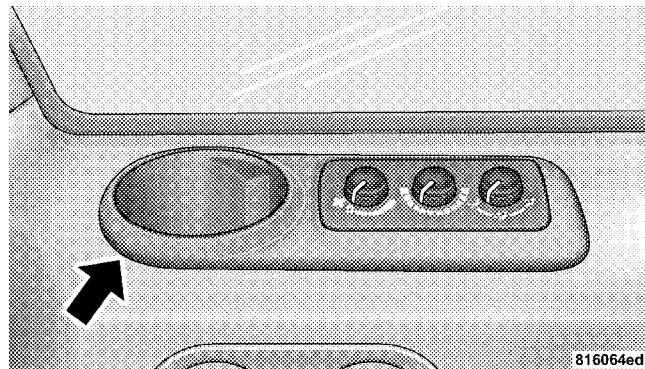

Cup Holders (Third Row Seat)

CARGO AREA FEATURES

Cargo Load Floor

The panel in the load floor is reversible for added utility. One side is carpeted and the other side features a plastic lined tray which holds a variety of items.

The cargo load floor is held by spring loaded latches. In order to use the cargo load floor, use the following procedure:

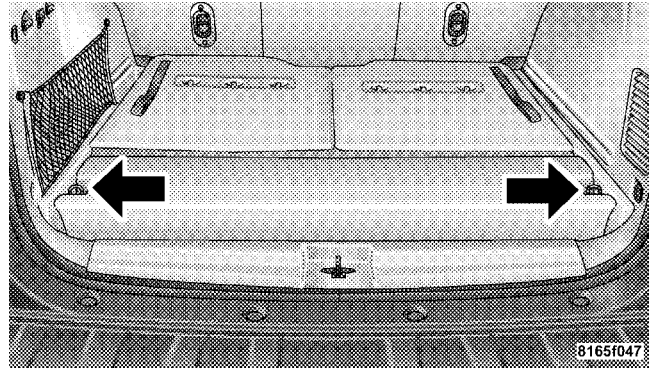

Rear Storage Cover

NOTE: The cargo load floor latches should not be used as cargo tie-downs.

1. Flip up pull loop(s) so they are perpendicular (straight up) to the top surface of the tray.

2. Pull up on loop(s) and twist 90 degrees, so they are parallel to the slotted hole in tray.
3. Lift tray over loop(s), and reposition tray.

4. Pull up on loop(s) and twist 90 degrees, so they are perpendicular (straight up) to the slotted hole in tray.
5. Push loop(s) back down, so they are parallel to the top of the tray.

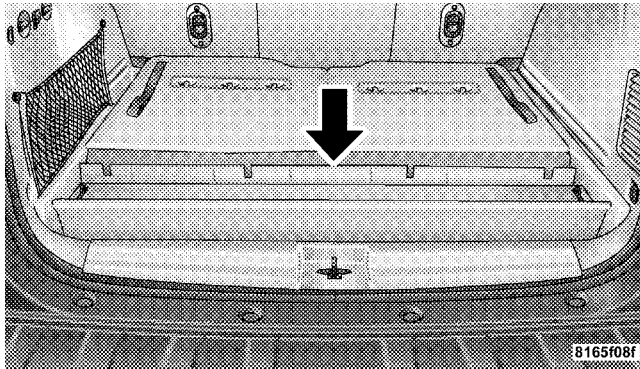

Cargo Load Floor

REAR WINDOW FEATURES

Rear Window Wiper/Washer

A switch on the right side of the steering column controls operation of the rear wiper/washer function. Rotating the center of the switch up to the DEL (Delay) position or the ON position will activate the wiper. Rotating the center of the switch all the way up or down will turn on the wash function. The wash pump will continue to operate as long as the button is pressed. Upon release, the wipers will cycle three times before returning to the set position.

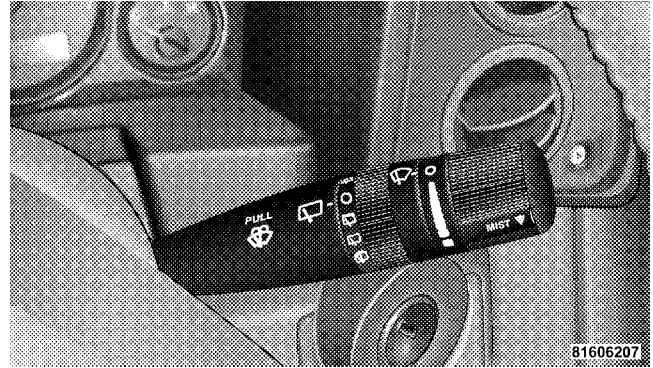

Rear Wiper/Washer Switch

If the rear wiper is operating when the ignition is turned OFF, the wiper will automatically return to the “Park” position.

If the liftgate flipper glass is open, connection to the rear window wiper is interrupted preventing activation of the rear wiper blade. When the liftgate flipper glass is closed,

the rear wiper switch or the ignition switch needs to be turned OFF and ON to restart the rear wiper.

Adding Washer Fluid

The fluid reservoir for the windshield washers and the rear window washer is shared. It is located in the front of the engine compartment on the passenger side and should be checked for fluid level at regular intervals. Fill the reservoir with windshield washer solvent (not radiator antifreeze) and operate the system for a few seconds to flush out the residual water.

Rear Window Defroster — If Equipped



Press this button (located on the Climate Control panel) to turn on the rear window defroster and the heated side mirrors (if equipped). An LED in the button will illuminate to indicate the rear window defroster is ON. The defroster automatically turns off after about 10 minutes of operation.

CAUTION!

To avoid damaging the electrical conductors of the rear window defroster, do not use scrapers, sharp instruments, or abrasive window cleaners on the interior surface of the window.

Labels can be peeled off after soaking with warm water.

3

ROOF LUGGAGE RACK — IF EQUIPPED

External racks do not increase the total load carrying capacity of the vehicle. Be sure that the total occupant and luggage load inside the vehicle, plus the load on the luggage rack, do not exceed the rated vehicle capacity.

This vehicle is not equipped with roof rack cross rails as built, unless ordered as optional equipment. Cross rails must be installed prior to carrying loads on the roof rack.

If not equipped, your authorized dealer can order and install Mopar® cross rails built specifically for this roof rack system or a number of after market rails that are tailored to your life-style or activities.

The optional cross rails have five specific locations identified by a feature on both the side rail and the cross rail. Cross rails must be secured in one of the five detent locations on the side rail to prevent movement with a sudden stop. The cross rails must also be installed using the correct orientation (the longer rail toward the front) with the wind trip toward the front of the vehicle as shown below. For improved windnoise performance when cross rails are not in use, place them in detent positions #1 (first detent from the front of the vehicle) and #4 (second detent from the rear of the vehicle) as indicated with a unique feature on the side rails. **The grab handles (A) on the back of the vehicle (if equipped) are not to be used as a towing feature.**

NOTE: If the rear cross rail (or any metallic object) is placed over the satellite radio antenna (if equipped), you may experience interruption of satellite radio reception. For improved satellite radio reception, place the rear cross rail in detent position #4 when not in use.

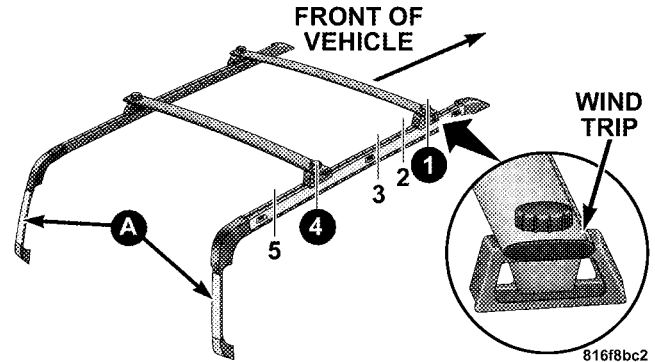

Cross Rail Positions

CAUTION!

- To prevent damage to the roof of your vehicle, **DO NOT** carry any loads on the roof rack without cross rails installed. The load should be secured and placed on top of the cross rails, not directly on the roof. If it is necessary to place the load on the roof, place a blanket or some other protection between the load and the roof surface.
- To avoid damage to the roof rack and vehicle, do not exceed the rated load capacity of your cross rail system or the roof rack system maximum load capacity of 150 lbs (68 kg). Always distribute heavy loads as evenly as possible and secure the load appropriately.
- Long loads which extend over the windshield, such as wood panels or surfboards, should be secured to both the front and rear of the vehicle.
- Travel at reduced speeds and turn corners carefully when carrying large or heavy loads on the roof rack. Wind forces, due to natural causes or nearby truck traffic, can add sudden upward loads. This is especially true on large flat loads and may result in damage to the cargo or your vehicle.

WARNING!

Cargo must be securely tied before driving your vehicle. Improperly secured loads can fly off the vehicle, particularly at high speeds, resulting in personal injury or property damage. Follow the roof rack “Cautions” when carrying cargo on your roof rack.

UNDERSTANDING YOUR INSTRUMENT PANEL

CONTENTS

■ Instrument Panel And Controls	185	□ Personal Settings (Customer Programmable Features)	205
■ Instrument Cluster	186	□ System Status	209
■ Instrument Cluster Description	187	■ Radio General Information	210
■ Electronic Vehicle Information Center (EVIC)	195	□ Radio Broadcast Signals	210
□ Electronic Vehicle Information Center (EVIC) Displays	197	□ Two Types Of Signals	211
□ Engine Oil Change Indicator System	200	□ Electrical Disturbances	211
□ Trip Functions	200	□ AM Reception	211
□ Compass Display	203	□ FM Reception	211

- Sales Code REQ — AM/FM Stereo Radio And 6-Disc CD/DVD Changer (MP3/WMA AUX Jack)212
 - Operating Instructions - Radio Mode212
 - Operation Instructions - (Disc Mode For CD And MP3/WMA Audio Play, DVD-Video)220
 - Notes On Playing MP3/WMA Files222
 - List Button (Disc Mode For MP3/WMA Play)225
 - Info Button (Disc Mode For MP3/WMA Play)225
- Sales Code RES — AM/FM Stereo Radio With CD Player (MP3 AUX Jack)227
 - Operating Instructions - Radio Mode227
 - Operation Instructions - CD Mode For CD And MP3 Audio Play233
 - Notes On Playing MP3 Files235
 - List Button (CD Mode For MP3 Play)238
 - Info Button (CD Mode For MP3 Play)238
- Sales Code REN — Multimedia System — If Equipped239
 - Operating Instructions — Satellite Radio (If Equipped)240
 - Operating Instructions — Hands-Free Communication (UConnect™) (If Equipped) . . .240
 - Clock Setting Procedure240
- Sales Code RER — AM/FM/CD/DVD Radio With Navigation System — If Equipped242
 - Operating Instructions — Satellite Radio243

□ Clock Setting Procedure	243	□ Reception Quality	250
■ Universal Consumer Interface (UCI) — If Equipped	244	□ Operating Instructions - Satellite Mode	250
□ Connecting The iPod®	245	□ Operating Instructions - Hands Free Phone (If Equipped)	253
□ Controlling The iPod® Using Radio Buttons	245	□ Operating Instructions - Video Entertainment System (VES®) (If Equipped)	253
□ Play Mode	245	■ Video Entertainment System (Sales Code XRV) — If Equipped	253
□ List Or Browse Mode	247	■ Remote Sound System Controls — If Equipped	254
■ Satellite Radio (RSC) — If Equipped (REQ And RES Radios Only)	249	□ Radio Operation	255
□ System Activation	249	□ CD Player	255
□ Electronic Serial Number/Sirius Identification Number (ENS/SID)	249	■ CD/DVD Disc Maintenance	256
□ Selecting Satellite Mode	250	■ Radio Operation And Cellular Phones	256
□ Satellite Antenna	250	■ Climate Controls	257

184 UNDERSTANDING YOUR INSTRUMENT PANEL

□ Manual Air Conditioning And Heating System — If Equipped	257	□ Rear Climate Control — If Equipped	267
□ Automatic Temperature Control — If Equipped	260	□ Operating Tips	269
		□ Operating Tips Chart	272

INSTRUMENT PANEL AND CONTROLS

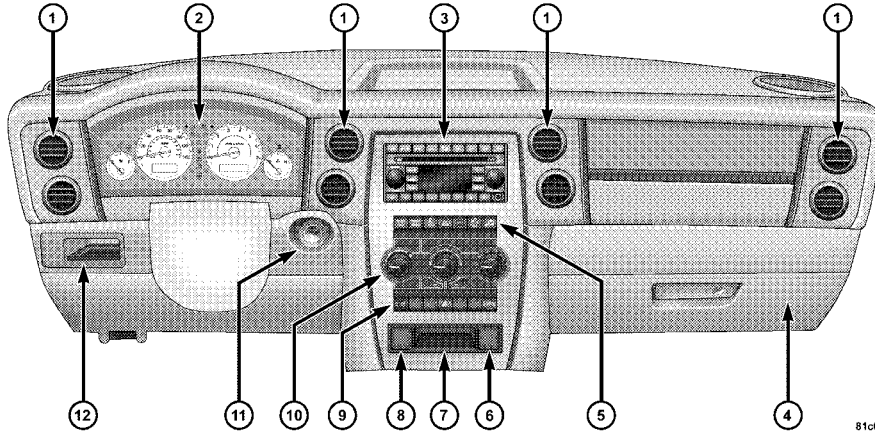

81c0b358

- 1 — Air Outlet
- 2 — Instrument Cluster
- 3 — Radio
- 4 — Glove Box

- 5 — Upper Switch Bank
- 6 — Power Outlet/Cigar Lighter
- 7 — Storage Bin
- 8 — Power Outlet

- 9 — Lower Switch Bank
- 10 — Climate Controls
- 11 — Ignition Switch
- 12 — Storage Bin

INSTRUMENT CLUSTER

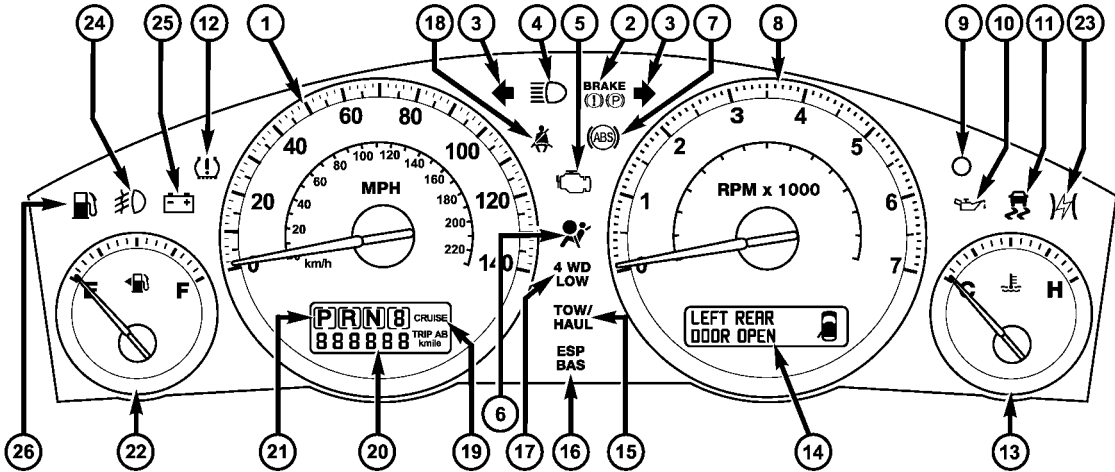

819e550f

INSTRUMENT CLUSTER DESCRIPTION

1. *Speedometer*

Indicates vehicle speed.

2. *Brake Warning Light*



The BRAKE warning light will come on when the ignition is first turned on, and stay on briefly as a bulb check. If the bulb does not come on during starting, have the bulb repaired promptly. If the light stays on longer, it may be an indication that the parking brake has not been released.

If the light remains on when the parking brake is off, it indicates a possible brake hydraulic system malfunction or low fluid level. In this case, the “Brake Warning Light” will remain on until the cause is corrected. If a brake malfunction is indicated, immediate repair is necessary and continued operation of the vehicle in this condition is dangerous.

3. *Turn Signal Indicator Light*



The arrow will flash with the exterior turn signal when the turn signal lever is operated.

If the vehicle electronics sense that the vehicle has traveled about one mile with the turn signals on, a chime will sound to alert you to turn the signals off. If either indicator flashes at a rapid rate, check for a defective outside light bulb.

4. *High Beam Indicator Light*



Indicates that headlights are on high beam.

5. *Malfunction Indicator Light*



This light is part of an onboard diagnostic system called OBD II that monitors engine and automatic transmission control systems. The light will illuminate when the key is in the ON position before

engine start. If the bulb does not come on when turning the key from OFF to ON, have the condition checked promptly.

Certain conditions such as a loose or missing gas cap, poor fuel quality, etc. may illuminate the light after engine start. The vehicle should be serviced if the light stays on through several of your typical driving cycles. In most situations the vehicle will drive normally and will not require towing.

The Malfunction Indicator Light flashes to alert you to serious conditions that could lead to immediate loss of power or severe catalytic converter damage. The vehicle should be serviced as soon as possible if this occurs.

6. *Airbag Warning Light*



This light turns on and remains on for 6 to 8 seconds as a bulb check when the ignition switch is first turned ON. If the light is not on

during starting, stays on, or turns on while driving, have the system inspected by an authorized dealer as soon as possible.

7. *Anti-Lock Brake Warning Light*



This light monitors the Anti-Lock Brake System. The light will turn on when the ignition switch is turned to the ON position and may stay on for as long as four seconds.

If the ABS light remains on or turns on while driving, it indicates that the Anti-Lock portion of the brake system is not functioning and that service is required. However, the conventional brake system will continue to operate normally if the BRAKE warning light is not on.

If the ABS light is on, the brake system should be serviced as soon as possible to restore the benefits of Anti-Lock brakes. If the ABS light does not turn on when the Ignition switch is turned to the ON position, have the light inspected by an authorized dealer.

8. Tachometer

The red segments indicate the maximum permissible engine revolutions-per-minute (r.p.m. x 1000) for each gear range. Before reaching the red area, ease up on the accelerator.

9. Security Alarm System Indicator Light — If Equipped

This light will flash rapidly for approximately 15 seconds when the vehicle theft alarm is arming. The light will flash at a slower speed continuously after the alarm is set. The security light will also come on for about three seconds when the ignition is first turned on.

10. Oil Pressure Warning Light

 This light shows low engine oil pressure. The light should turn on momentarily when the engine is started. If the light turns on while driving, stop the vehicle, and shut off the engine as soon as possible. A continuous chime will sound when this light turns on.

Do not operate the vehicle until the cause is corrected. This light does not show how much oil is in the engine. The engine oil level must be checked under the hood.

11. Electronic Stability Program (ESP) Indicator Light/Traction Control System (TCS) Indicator Light



This indicator light starts to flash as soon as the tires lose traction and the ESP system becomes active. The “ESP/TCS Indicator Light” also flashes when TCS is active. If the “ESP/TCS Indicator Light” begins to flash during acceleration, ease up on the accelerator and apply as little throttle as possible. Be sure to adapt your speed and driving to the prevailing road conditions. The “ESP/TCS Indicator Light” will flash any time the ESP or TCS is active and helping to improve vehicle stability. If the “ESP/TCS Indicator Light” is on solid, the ESP system has been turned off by the driver or a temporary condition exists that will not allow full ESP function.

12. *Tire Pressure Monitoring Telltale Light*



Each tire, including the spare (if provided), should be checked monthly when cold and inflated to the inflation pressure recommended by the vehicle manufacturer on the vehicle placard or tire inflation pressure label. (If your vehicle has tires of a different size than the size indicated on the vehicle placard or tire inflation pressure label, you should determine the proper tire inflation pressure for those tires.)

As an added safety feature, your vehicle has been equipped with a tire pressure monitoring system (TPMS) that illuminates a low tire pressure telltale when one or more of your tires are significantly under-inflated. Accordingly, when the low tire pressure telltale illuminates, you should stop and check your tires as soon as possible, and inflate them to the proper pressure. Driving on a significantly under-inflated tire causes the tire to over-heat and can lead to tire failure. Under-inflation also

reduces fuel efficiency and tire tread life, and may affect the vehicle's handling and stopping ability.

Please note that the TPMS is not a substitute for proper tire maintenance, and it is the driver's responsibility to maintain correct tire pressure, even if under-inflation has not reached the level to trigger illumination of the TPMS low tire pressure telltale.

Your vehicle has also been equipped with a TPMS malfunction indicator to indicate when the system is not operating properly. The TPMS malfunction indicator is combined with the low tire pressure telltale. When the system detects a malfunction, the telltale will flash for approximately one minute and then remain continuously illuminated. This sequence will continue upon subsequent vehicle start-ups as long as the malfunction exists. When the malfunction indicator is illuminated, the system may not be able to detect or signal low tire pressure as intended. TPMS malfunctions may occur for a variety

of reasons, including the installation of replacement or alternate tires or wheels on the vehicle that prevent the TPMS from functioning properly. Always check the TPMS malfunction telltale after replacing one or more tires or wheels on your vehicle to ensure that the replacement or alternate tires and wheels allow the TPMS to continue to function properly.

CAUTION!

The TPMS has been optimized for the original equipment tires and wheels. TPMS pressures and warning have been established for the tire size equipped on your vehicle. Undesirable system operation or sensor damage may result when using replacement equipment that is not of the same size, type, and/or style. After-market wheels can cause sensor damage. Do not use aftermarket tire sealants or balance beads if your vehicle is equipped with a TPMS, as damage to the sensors may result.

4

13. Temperature Gauge

The temperature gauge shows engine coolant temperature. Any reading within the normal range indicates that the engine cooling system is operating satisfactorily.

The gauge pointer will likely indicate a higher temperature when driving in hot weather, up mountain grades, or when towing a trailer. It should not be allowed to exceed the upper limits of the normal operating range.

CAUTION!

Driving with a hot engine cooling system could damage your vehicle. If temperature gauge reads (H), pull over and stop the vehicle. Idle the vehicle with the air conditioner turned off until the pointer drops back into the normal range. If the pointer remains on the “H”, and you hear continuous chimes, turn the engine off immediately, and call for service.

WARNING!

A hot engine cooling system is dangerous. You or others could be badly burned by steam or boiling coolant. If you decide to look under the hood yourself, refer to Section 7 of this manual. Follow the warnings under “Cooling System Pressure Cap.”

14. *Electronic Vehicle Information Center Display*

When the appropriate conditions exist, this display shows the Electronic Vehicle Information Center (EVIC) messages. Refer to “Electronic Vehicle Information Center” later in this section.

15. *TOW/HAUL Indicator Light*

**TOW/
HAUL**

This light will illuminate when the TOW/HAUL button has been selected. The TOW/HAUL button is located in the center of the instrument panel (below the climate controls).

16. Electronic Stability Program (ESP) Warning Light/Brake Assist System (BAS) Warning Light

ESP BAS

The ESP/BAS warning light in the instrument cluster comes on when the ignition switch is turned to the “ON” position. The light should go out with the engine running. If the ESP/BAS warning light comes on continuously with the engine running, a malfunction has been detected in either the ESP or the BAS system. If this light stays illuminated, have the ESP and BAS checked at your authorized dealer as soon as possible.

17. 4WD LOW Mode Indicator Light — If Equipped

4 WD LOW

This light alerts the driver that the vehicle is in the 4WD LOW mode. The front and rear drive-shafts are mechanically locked together forcing the front and rear wheels to rotate at the same speed.

18. Seat Belt Reminder Light



When the ignition switch is first turned ON, this light will turn on for 5 to 8 seconds as a bulb check. During the bulb check, if the driver’s seat belt is unbuckled, a chime will sound. After the bulb check or when driving, if the driver or front passenger seat belt remains unbuckled, the Seat Belt Warning Light will flash or remain on continuously. Refer to “Enhanced Driver Seat Belt Reminder System (BeltAlert)” in the Occupant Restraints section for more information.

19. Cruise Indicator Light

CRUISE This indicator lights when the speed control system is turned ON.

20. Odometer

The odometer shows the total distance the vehicle has been driven.

U.S. federal regulations require that upon transfer of vehicle ownership, the seller certify to the purchaser the correct mileage that the vehicle has been driven. Therefore, if the odometer reading is changed during repair or replacement, be sure to keep a record of the reading before and after the service so that the correct mileage can be determined.

21. Transmission Range Indicator

This display indicator shows the automatic transmission gear selection.

22. Fuel Gauge

The pointer shows the level of fuel in the fuel tank when the ignition switch is in the ON position.

23. Electronic Throttle Control (ETC) Warning Light — If Equipped



This light informs you of a problem with the Electronic Throttle Control system. If a problem is detected the light will come on while the

engine is running. Cycle the ignition key when the vehicle has completely stopped and the gear selector is placed in the P (Park) position. The light should turn off. If the light remains lit with the engine running your vehicle will usually be drivable, however, see your dealer for service as soon as possible. If the light is flashing when the engine is running, immediate service is required and you may experience reduced performance, an elevated/rough idle or engine stall and your vehicle may require towing. The light will come on when the ignition is first turned on and remain on briefly as a bulb check. If the light does not come on during starting, have the system checked by an authorized dealer.

24. Front Fog Light Indicator Light— If Equipped

 This light shows the front fog lights are ON.

25. Voltage Warning Light



This light monitors the electrical system voltage. The light should turn on momentarily as the engine is started. If the light stays on or turns on while driving, it indicates a problem with the charging system. Immediate service should be obtained.

26. Low Fuel Warning Light



When the fuel level reaches approximately 2.3 U.S. Gallons (8.7 Liters) this light will come on and remain on until fuel is added. The Low Fuel Warning Light may turn on and off again, especially during and after hard braking, accelerations, or turns. This occurs due to the shifting of the fuel in the tank. Also, a single chime will sound.

ELECTRONIC VEHICLE INFORMATION CENTER (EVIC)

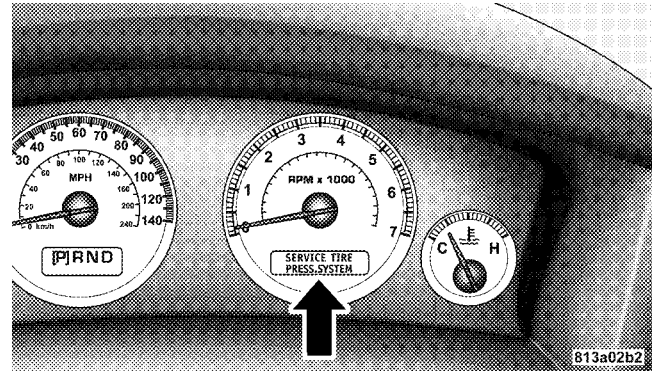

The Electronic Vehicle Information Center (EVIC) features a driver-interactive display. It is located on the bottom of the tachometer in the instrument cluster. The EVIC consists of the following:

- System Status

- Vehicle Information Warning Message Displays
- Personal Settings (Customer Programmable Features)
- Compass Display
- Outside Temperature Display
- Trip Computer Functions

The system allows the driver to select information by pressing the following buttons mounted on the steering wheel:

MENU Button



Press and release the MENU button and the mode displayed will change between Trip Functions, Personal Settings, and System Status.

FUNCTION SELECT Button



Press the FUNCTION SELECT button to select the displayed function (YES (Y) or NO (N)).

SCROLL Button



Press the SCROLL button to scroll through Trip Functions, Personal Settings (Customer Programmable Features), and System Status Messages.

COMPASS/TEMPERATURE Button



Press and release the COMPASS/TEMPERATURE button to display one of eight compass readings and the outside temperature.

Electronic Vehicle Information Center (EVIC)

Displays

When the appropriate conditions exist, the Electronic Vehicle Information Center (EVIC) displays the following messages:

- TURN SIGNAL ON
- PERFORM SERVICE
- KEY NOT PROGRAMMED — DAMAGED KEY
- KEY NOT PROGRAMMED — INVALID KEY
- KEY NOT PROGRAMMED — EXCEEDED KEY PROGRAM LIMIT
- PROGRAMMING ACTIVE — NEW KEY PROGRAMMED
- SERVICE SECURITY KEY
- INVALID KEY — TRY ALTERNATE KEY
- DRIVER/PASSENGER DOOR OPEN (with graphic)
- LEFT/RIGHT REAR DOOR OPEN (with graphic)
- X DOORS OPEN (with graphic)
- LIFTGATE OPEN (with graphic)
- LIFTGATE/DOOR OPEN (with graphic)
- LIFTGATE/DOORS OPEN (with graphic)
- LIFTGLASS OPEN (with graphic)
- HOOD OPEN (with graphic)
- HOOD/DOOR OPEN (with graphic)
- HOOD/DOORS OPEN (with graphic)
- LIFTGATE/HOOD OPEN (with graphic)
- HOOD/GLASS/DOOR OPEN (with graphic)
- HOOD/GLASS/DOORS OPEN (with graphic)

198 UNDERSTANDING YOUR INSTRUMENT PANEL

- HOOD/GATE/DOOR OPEN (with graphic)
- HOOD/GATE/DOORS OPEN (with graphic)
- LIFTGLASS/DOOR OPEN (with graphic)
- LIFTGLASS/DOORS OPEN (with graphic)
- LIFTGLASS/HOOD OPEN (with graphic)
- WASHER FLUID LOW (with graphic)
- COOLANT LOW (with graphic)
- OIL CHANGE REQUIRED
- OIL CHANGE RESET
- CHECK GAUGES
- AUTO HIGH BEAMS ON
- AUTO HIGH BEAMS OFF
- PARK ASSIST DISABLED
- SERVICE SUSPENSION
- SERVICE PARK ASSIST SYSTEM
- TRANSMISSION OVER TEMP
- CHECK SHIFT PROCEDURE
- SERVICE 4WD SYSTEM
- 4WD SYSTEM IN NEUTRAL
- LOW BRAKE FLUID LEVEL
- WARNING! LIMIT SPEED
- CHECK GASCAP
- ESP OFF
- IOD FUSE OUT
- HILL DESCENT CONTROL
- MEMORY #1 POSITIONS SET

- MEMORY #2 POSITIONS SET
- MEMORY SYSTEM DISABLED — SEATBELT BUCKLED (with graphic)
- MEMORY SYSTEM DISABLED — VEHICLE NOT IN PARK
- DRIVER 1 MEMORY
- DRIVER 2 MEMORY
- ADJ. PEDALS DISABLED — CRUISE CONTROL SET
- ADJ. PEDALS DISABLED — SHIFTER IN REVERSE
- TIRE LOW PRESSURE
- CHECK TPM SYSTEM
- LEFT FRONT LOW PRESSURE (Premium TPM System Only)
- RIGHT FRONT LOW PRESSURE (Premium TPM System Only)
- LEFT REAR LOW PRESSURE (Premium TPM System Only)
- RIGHT REAR LOW PRESSURE (Premium TPM System Only)
- SPARE LOW PRESSURE (Premium TPM System Only)
- UNLOCK TO OPERATE (Power Liftgate Models Only)
- PUT IN PARK TO OPERATE (Power Liftgate Models Only)
- FUNCTION DISABLED (Power Liftgate Models Only)
- CLOSE LIFTGLASS (Power Liftgate Models Only)
- OBSTACLE DETECTED (Power Liftgate Models Only)
- MANUAL CLOSE TO OPERATE (Power Liftgate Models Only)

Engine Oil Change Indicator System

Oil Change Required

Your vehicle is equipped with an engine oil change indicator system. The “Oil Change Required” message will flash in the EVIC display for approximately 10 seconds after a single chime has sounded to indicate the next scheduled oil change interval. The engine oil change indicator system is duty cycle based, which means the engine oil change interval may fluctuate dependent upon your personal driving style.

Unless reset, this message will continue to display each time you turn the ignition switch to the ON/RUN position. To turn off the message temporarily, press and release the MENU button. To reset the oil change indicator system (after performing the scheduled maintenance) refer to the following procedure.

1. Turn the ignition switch to the ON position (Do not start the engine).

2. Fully depress the accelerator pedal slowly three times within 10 seconds.

3. Turn the ignition switch to the OFF/LOCK position.

NOTE: If the indicator message illuminates when you start the vehicle, the oil change indicator system did not reset. If necessary repeat this procedure.

Trip Functions

Press and release the MENU button until one of the following Trip Functions displays in the EVIC:

- Average Fuel Economy/Fuel Saver Mode (5.7L Engine Only)
- Distance To Empty
- Trip A
- Trip B
- Elapsed Time

- Service Distance
- Display Units of Measure in

Press the SCROLL button to cycle through all the Trip Computer functions.

The Trip Functions mode displays the following information:

- ***Average Fuel Economy / Fuel Saver Mode (5.7L Engine Only)***

Shows the average fuel economy since the last reset. When the fuel economy is reset, the display will read “RESET” or show dashes for two seconds. Then, the history information will be erased, and the averaging will continue from the last fuel average reading before the reset.

Vehicles with the 5.7L Multi-Displacement System (MDS) are equipped with the FUEL SAVER MODE in the Trip Functions of the EVIC. The FUEL SAVER message will

display above the average fuel economy in the EVIC display. This message will appear whenever MDS allows the engine to operate on four cylinders, which will vary depending on driving habits and vehicle usage.

EXAMPLE ONLY



FUEL SAVER MODE
Average MPG
23.5 ▶ Reset
1148 mi

4 Cylinder Operation - MDS On

819793f8

This feature allows you to monitor when the MDS switches off the fuel on four of the eight cylinders and it can be used to modify driving habits in order to increase the time in which the fuel saver mode is active.

EXAMPLE ONLY



Average MPG
23.5 ▶ Reset
1148 mi

819793f4

8 Cylinder Operation - MDS Off

- ***Distance To Empty (DTE)***

Shows the estimated distance that can be traveled with the fuel remaining in the tank. This estimated distance is determined by a weighted average of the instantaneous and average fuel economy, according to the current fuel tank level. DTE cannot be reset through the FUNCTION SELECT button.

NOTE: Significant changes in driving style or vehicle loading will greatly affect the actual drivable distance of the vehicle, regardless of the DTE displayed value.

- When the DTE value is less than 30 miles (48 km) estimated driving distance, the DTE display will change to a text display of "LOW FUEL." This display will continue until the vehicle runs out of fuel. Adding a significant amount of fuel to the vehicle will turn off the "LOW FUEL" text and a new DTE value will display.

- **Trip A**

Shows the total distance traveled for trip A since the last reset.

- **Trip B**

Shows the total distance traveled for trip B since the last reset.

- **Elapsed Time**

Shows the total elapsed time of travel since the last reset when the ignition switch is in the ACC position. Elapsed time will increment when the ignition switch is in the ON or START position.

- **Display Units of Measure in:**

To make your selection, press and release the FUNCTION SELECT button until “US” or “METRIC” appears.

To Reset The Display

Reset will only occur while a resettable function is being displayed. Press and release the FUNCTION SELECT

button once to clear the resettable function being displayed. To reset all resettable functions, press and release the FUNCTION SELECT button a second time within 3 seconds of resetting the currently displayed function (>Reset ALL will display during this 3 second window).

Compass Display



The compass readings indicate the direction the vehicle is facing. Press and release the compass button to display one of eight compass readings and the outside temperature.

4

Automatic Compass Calibration

This compass is self-calibrating, which eliminates the need to manually reset the compass. When the vehicle is new, the compass may appear erratic and the EVIC will display “CAL” until the compass is calibrated. You may also calibrate the compass by completing one or more 360° turns (in an area free from large metal or metallic

objects) until the “CAL” indicator displayed in the EVIC turns off. The compass will now function normally.

Manual Compass Calibration

If the compass appears erratic and the “CAL” indicator does not appear in the EVIC display, you must put the compass into the Calibration Mode manually as follows:

1. Turn on the ignition switch.
2. Press the MENU button until Personal Settings (Customer Programmable Features) menu is reached.
3. Press the SCROLL button until “Calibrate Compass” is displayed in the EVIC.
4. Press and release the FUNCTION SELECT button to start the calibration. The “CAL” indicator will be displayed in the EVIC.

5. Complete one or more 360° turns (in an area free from large metal or metallic objects) until the “CAL” indicator turns off. The compass will now function normally.

Compass Variance

Compass Variance is the difference between magnetic North and Geographic North. In some areas of the country, the difference between magnetic and geographic North is great enough to cause the compass to give false readings. For the most accurate compass performance, the compass variance must be set using the following procedure:

NOTE: Magnetic materials should be kept away from the top of the right rear quarter window. This is where the compass sensor is located.

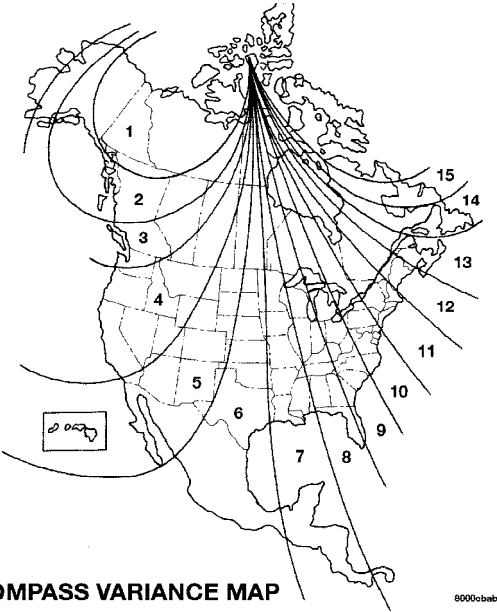

1. Turn the ignition switch ON.
2. Press and hold the compass button for approximately 2 seconds.
3. Press the SCROLL button until “Compass Variance” message and the last variance zone number displays in the EVIC.
4. Press and release FUNCTION SELECT button until the proper variance zone is selected according to the map.
5. Press and release the compass button to exit.

4

Personal Settings (Customer Programmable Features)

Personal Settings allows the driver to set and recall features when the transmission is in P (Park).

Press and release the MENU button until Personal Settings displays in the EVIC.

Use the SCROLL button to display one of the following choices:

Language

When in this display you may select one of three languages for all display nomenclature, including the trip functions and the navigation system (if equipped). Press the FUNCTION SELECT button while in this display to select English, Espanol, or Francais. Then, as you continue, the information will display in the selected language.

NOTE: The EVIC will not change the UConnect™ language selection. Please refer to “Language Selection” in the HANDS-FREE COMMUNICATION (UConnect™) section of this manual for details.

Auto Door Locks

When Y (YES) is selected, all of the doors will lock automatically when the vehicle reaches a speed of 15

mph (24 km/h). To make your selection, press and release the FUNCTION SELECT button until “Y (YES)” or “N (NO)” appears.

Auto Unlock On Exit

When Y (YES) is selected, all of the doors will unlock when the vehicle is stopped and the transmission is in the P (Park) or N (Neutral) position and the driver’s door is opened. To make your selection, press and release the FUNCTION SELECT button until “Y (YES)” or “N (NO)” appears.

Remote Key Unlock

When **Driver Door 1st Press** is selected, only the driver’s door will unlock on the first press of the remote keyless entry unlock button. When Driver Door 1st Press is selected, you must press of the remote keyless entry unlock button twice to unlock the passenger’s doors. When **All Doors 1st Press** is selected, all of the doors will unlock on the first press of the remote keyless entry

unlock button. To make your selection, press and release the FUNCTION SELECT button until “Driver Door 1st Press” or “All Doors 1st Press” appears.

Sound Horn with Lock

When Y (YES) is selected, a short horn sound will occur when the remote keyless entry “Lock” button is pressed. This feature may be selected with or without the flash lights on lock/unlock feature. To make your selection, press and release the FUNCTION SELECT button until “Y (YES)” or “N (NO)” appears.

Flash Lamps with Lock

When Y (YES) is selected, the front and rear turn signals will flash when the doors are locked or unlocked with the remote keyless entry transmitter. This feature may be selected with or without the sound horn on lock feature selected. To make your selection, press and release the FUNCTION SELECT button until “Y (YES)” or “N (NO)” appears.

Headlamp Off Delay

When this feature is selected, the driver can choose to have the headlights remain on for 0, 30, 60, or 90 seconds when exiting the vehicle. To make your selection, press and release the FUNCTION SELECT button until “0,” “30,” “60,” or “90” appears.

Automatic High Beams (Available with SmartBeam Only)

When this feature is selected, the high beam headlights will deactivate automatically under certain conditions. To make your selection, press and release the FUNCTION SELECT button until “Y (YES)” or “N (NO)” appears. Refer to “Lights/SmartBeams — If Equipped” in Section 3 of this manual for more information.

Headlights On with Wipers (Available with Auto Headlights Only)

When Y (YES) is selected, and the headlight switch is in the AUTO position, the headlights will turn on approximately 10 seconds after the wipers are turned on. The headlights will also turn off when the wipers are turned off if they were turned on by this feature. To make your selection, press and release the FUNCTION SELECT button until “Y (YES)” or “N (NO)” appears.

NOTE: Turning the headlights on during the daytime causes the instrument panel lights to dim. To increase the brightness, refer to “Lights” in Section 3 of this manual.

Rain Sensing Intermittent Wipers — If Equipped

When Y (YES) is selected, the system will automatically activate the windshield wipers if it senses moisture on the windshield. To make your selection, press and release the FUNCTION SELECT button until “Y (YES)” or “N

(NO)” appears. When N (NO) is selected, the system reverts to the standard intermittent wiper operation.

Easy Entry/Exit Seat (Available with Memory Seat Only)

This feature provides automatic driver seat positioning to enhance driver mobility when entering and exiting the vehicle. To make your selection, press and release the FUNCTION SELECT button until “Y (YES)” or “N (NO)” appears.

NOTE: The seat will return to the memorized seat location (if Recall Memory with Remote Key Unlock is set to ON) when the remote keyless entry transmitter is used to unlock the door. Refer to “Easy Entry/Exit Seat” under “Driver Memory Seat” in Section 3 of this manual for more information.

Key Off Power Delay

When this feature is selected, the power window switches, radio, hands-free system (if equipped), DVD video system (if equipped), power sunroof (if equipped), and power outlets will remain active for up to 60 minutes after the ignition switch is turned off. Opening a vehicle door will cancel this feature. To make your selection, press and release the FUNCTION SELECT button until “Off,” “45 sec.,” “5 min.,” or “10 min.” appears.

Illuminated Approach

When this feature is selected, the headlights will activate and remain on for up to 90 seconds when the doors are unlocked with the remote keyless entry transmitter. To make your selection, press and release the FUNCTION SELECT button until “OFF,” “30 sec.,” “60 sec.,” or “90 sec.” appears.

Hill Start Assist

To make your selection, press and release the FUNCTION SELECT button until “Y (YES)” or “N (NO)” appears.

Display Units of Measure in

The EVIC, odometer, and navigation system (if equipped) can be changed between English and Metric units of measure. To make your selection, press and release the FUNCTION SELECT button until “US” or “METRIC” appears.

System Status

Press and release the MENU button until one of the following System Status messages displays in the EVIC:

- System OK
- System Warnings Displayed (Will display all currently active System Warnings.)

210 UNDERSTANDING YOUR INSTRUMENT PANEL

- Tire Pressure Monitor System (Shows the current pressure of all 4 road tires.) For additional information, refer to “Tire Pressure Monitor System” in Section 5 of this manual.

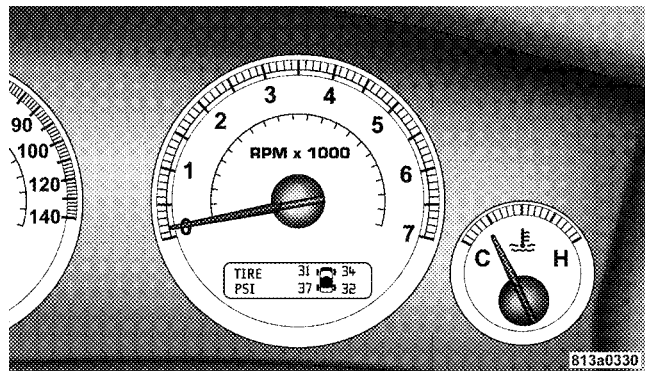

Tire Pressure Display

NOTE: Tires heat up during normal driving conditions. Heat will cause the tire pressure to increase from 2 to 6 psi (14 to 41 kPa) during normal driving conditions. Refer to “Tire Inflation Pressures” in Section 5 for additional information.

NOTE: Your system can be set to display pressure units in PSI, kPa, or BAR.

RADIO GENERAL INFORMATION

Radio Broadcast Signals

Your new radio will provide excellent reception under most operating conditions. Like any system, however, car radios have performance limitations, due to mobile operation and natural phenomena, which might lead you to believe your sound system is malfunctioning. To help you understand and save you concern about these “apparent” malfunctions, you must understand a point or two about the transmission and reception of radio signals.

Two Types of Signals

There are two basic types of radio signals... AM or Amplitude Modulation, in which the transmitted sound causes the amplitude, or height, of the radio waves to vary... and FM or Frequency Modulation, in which the frequency of the wave is varied to carry the sound.

Electrical Disturbances

Radio waves may pick up electrical disturbances during transmission. They mainly affect the wave amplitude, and thus remain a part of the AM reception. They interfere very little with the frequency variations that carry the FM signal.

AM Reception

AM sound is based on wave amplitude, so AM reception can be disrupted by such things as lightning, power lines and neon signs.

FM Reception

Because FM transmission is based on frequency variations, interference that consists of amplitude variations can be filtered out, leaving the reception relatively clear, which is the major feature of FM radio.

NOTE: The radio, steering wheel radio controls (if equipped), and 6 disc CD/DVD changer (if equipped) will remain active for up to 10 minutes after the ignition switch has been turned off. Opening a vehicle front door will cancel this feature.

SALES CODE REQ — AM/FM STEREO RADIO AND 6-DISC CD/DVD CHANGER (MP3/WMA AUX JACK)

NOTE: The radio sales code is located on the lower right side of your radio faceplate.

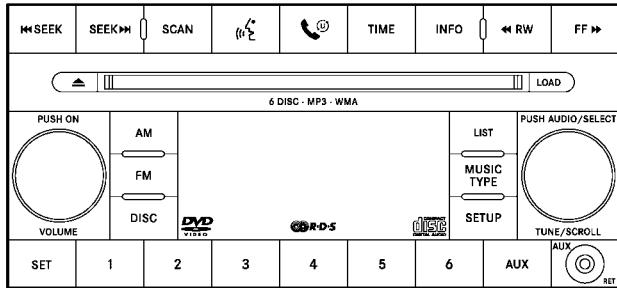

8189f8f9

REQ Radio

Operating Instructions - Radio Mode

NOTE: The ignition switch must be in the ON or ACC position to operate the radio.

Power Switch/Volume Control (Rotary)

Press the ON/VOL control to turn the radio ON. Press the ON/VOL a second time to turn OFF the radio.

Electronic Volume Control

The electronic volume control turns continuously (360 degrees) in either direction without stopping. Turning the volume control to the right increases the volume and to the left decreases it.

When the audio system is turned on, the sound will be set at the same volume level as last played.

SEEK Buttons (Radio Mode)

Press and release the SEEK buttons to search for the next listenable station in AM/FM mode. Press the right switch to seek up and the left switch to seek down. The radio

will remain tuned to the new station until you make another selection. Holding either button will bypass stations without stopping until you release it.

SCAN Button (Radio Mode)

Pressing the SCAN button causes the tuner to search for the next listenable station, in AM, FM or Satellite (if equipped) frequencies, pausing for 5 seconds at each listenable station before continuing to the next. To stop the search, press the SCAN button a second time.

Voice Recognition Button (UConnect™ Hands Free Phone) — If Equipped

Press this button to operate the Hand Free Phone (UConnect™) feature (if equipped). Refer to “Hands-Free Communication (UConnect™)” in Section 3 for more information.

If your vehicle is not equipped with or this feature is not available on your vehicle, a “UConnect™ System Not Available” message will display on the radio screen.

Phone Button (UConnect™ Hands Free Phone) — If Equipped

Press this button to operate the Hand Free Phone (UConnect™) feature (if equipped). Refer to “Hands-Free Communication (UConnect™)” in Section 3 for more information.

If your vehicle is not equipped with or this feature is not available on your vehicle, a “UConnect™ System Not Available” message will display on the radio screen.

TIME Button

Press the TIME button and the time of day will display. In AM or FM mode, pressing the TIME button will switch between the time and frequency displays.

Clock Setting Procedure

1. Press and hold the TIME button, until the hours blink.
2. Adjust the hours by turning the right side TUNE control knob.

3. After adjusting the hours, press the right side TUNE control knob to set the minutes. The minutes will begin to blink.
4. Adjust the minutes using the right side TUNE control knob. Press the TUNE control knob to save time change.
5. To exit, press any button/knob or wait 5 seconds.

The clock can also be set by pressing the SETUP button and selecting the “SET HOME CLOCK” entry. Once in this display follow the above procedure, starting at step 2.

INFO Button (Radio Mode)

Press the INFO button for an RDS station (one with call letters displayed). The radio will return a Radio Text message broadcast from an FM station (FM mode only).

RW/FF (Radio Mode)

Pressing the rewind or fast forward button causes the tuner to search for the next frequency in the direction of the arrows. This feature operates in either AM, FM or Satellite (if equipped) frequencies.

TUNE Control (Radio Mode)

Turn the right side rotary control clockwise to increase or counter-clockwise to decrease the frequency.

Setting the Tone, Balance, and Fade

Press the rotary TUNE control knob and BASS will display. Turn the TUNE control knob to the right or left to increase or decrease the Bass tones.

Press the rotary TUNE control knob a second time and MID will display. Turn the TUNE control knob to the right or left to increase or decrease the Mid Range tones.

Press the rotary TUNE control knob a third time and TREBLE will display. Turn the TUNE control knob to the right or left to increase or decrease the Treble tones.

Press the rotary TUNE control knob a fourth time and BALANCE will display. Turn the TUNE control knob to the right or left to adjust the sound level from the right or left side speakers.

Press the rotary TUNE control knob a fifth time and FADE will display. Turn the TUNE control knob to the left or right to adjust the sound level between the front and rear speakers.

Press the rotary TUNE control knob again to exit setting tone, balance, and fade.

MUSIC TYPE Button (Radio Mode)

Pressing this button once will turn on the Music Type mode for 5 seconds. Pressing the Music Type button or turning the TUNE control knob within 5 seconds will allow the

program format type to be selected. Many radio stations do not currently broadcast Music Type information.

Toggle the Music Type button to select the following format types:

Program Type	16 Digit-Character Display
No program type or undefined	None
Adult Hits	Adlt Hit
Classical	Classicl
Classic Rock	Cls Rock
College	College
Country	Country
Foreign Language	Language
Information	Inform
Jazz	Jazz
News	News

Program Type	16 Digit-Character Display
Nostalgia	Nostalgia
Oldies	Oldies
Personality	Persnlty
Public	Public
Rhythm and Blues	R & B
Religious Music	Rel Musc
Religious Talk	Rel Talk
Rock	Rock
Soft	Soft
Soft Rock	Soft Rck
Soft Rhythm and Blues	Soft R&B
Sports	Sports
Talk	Talk
Top 40	Top 40
Weather	Weather

By pressing the SEEK button when the Music Type icon is displayed, the radio will be tuned to the next frequency station with the same selected Music Type name. The Music Type function only operates when in the FM mode.

If a preset button is activated while in the Music Type (Program Type) mode, the Music Type mode will be exited and the radio will tune to the preset station.

SETUP Button

Pressing the SETUP button allows you to select between the following items:

NOTE: Use the Tune Control Knob to scroll through the entries. Push the Audio/Select button to select an entry and make changes.

- **DVD Enter** - When the disc is in DVD Menu mode, selecting DVD Enter will allow you to play the current highlighted selection. Use the remote control to scroll up and down the menu (If Equipped).



- **DISC Play/Pause** - You can toggle between playing the DVD and pausing the DVD by pushing the SELECT button (If Equipped).
- **DVD Play Options** - Selecting the DVD Play Options will display the following:
 - **Subtitle** - Repeatedly Pressing SELECT will switch subtitles to different subtitle languages that are available on the disc (If Equipped).
 - **Audio Stream** - Repeatedly Pressing SELECT will switch to different audio languages (if supported on the disc) (If Equipped).

- **Angle** - Repeatedly Pressing SELECT will change the viewing angle if supported by the DVD disc (If Equipped).

NOTE: The available selections for each of the above entries varies depending upon the disc.

NOTE: These selections can only be made while playing a DVD.

- **VES Power** - Allows you to turn VES ON and OFF (If Equipped).
- **VES Lock** - Locks out rear VES remote controls (If Equipped).
- **VES CH1/CH2** - Allows the user to change mode of either the IR1 or IR2, wireless headphones, by pressing the Audio/Select button (If Equipped).

- **Set Home Clock** - Pressing the SELECT button will allow user to set the clock. Turn the TUNE control knob to adjust the hours and then press and turn the TUNE control knob to adjust the minutes. Press the TUNE control knob again to save changes.
- **Player Defaults** - Selecting this item will allow the user to scroll through the following items, and set defaults according to customer preference.

Menu Language — If Equipped

Selecting this item will allow the user to choose the default startup DVD menu language (effective only if language supported by disc). If customer wishes to select a language not listed, then scroll down and select "other." Enter the 4-digit country code using the TUNE control knob to scroll up and down to select the # and then push to select.

Audio Language — If Equipped

Selecting this item will allow the user to choose a default audio language (effective only if language supported by disc). If customer wishes to select a language not listed, then scroll down and select "other." Enter the country code using the TUNE control knob to scroll up and down to select the # and then push to select.

Subtitle Language — If Equipped

Selecting this item will allow the user to choose a default subtitle language (effective only if language supported by disc). If customer wishes to select a language not listed, then scroll down and select "other." Enter the country code using the TUNE control knob to scroll up and down to select the # and then push to select.

Subtitles — If Equipped

Selecting this item will allow the user to choose between subtitle OFF or ON.

Audio DRC — If Equipped

Selecting this item will allow the user to limit maximum audio dynamic range - The default is set to "High," and under this setting, dialogues will play at 11 db higher than if the setting is "Normal."

Aspect Ratio — If Equipped

Selecting this item will allow the user to choose between wide screen, pan scan, and letter box.

AutoPlay — If Equipped

When this is set to ON and a DVD video is inserted, it will bypass the DVD menu screen and automatically play the movie. In some rare cases, the DVD player may not auto play the main title. In such cases, use the menu button on the remote control to select desired title to play.

NOTE: The user will have to set these defaults before loading a disc. If changes are made to these settings after

a disc is loaded, changes will not be effective. Also, the defaults are effective only if the disc supports the customer-preferred settings.

AM and FM Buttons (Radio Mode)

Press the buttons to select AM or FM Modes.

SET Button (Radio Mode) — To Set the Push-Button Memory

When you are receiving a station that you wish to commit to push-button memory, press the SET button. The symbol SET 1 will now show in the display window. Select the button (1-6) you wish to lock onto this station and press and release that button. If a button is not selected within 5 seconds after pressing the SET button, the station will continue to play but will not be stored into push-button memory.

You may add a second station to each push-button by repeating the above procedure with this exception: Press the SET button twice and SET 2 will show in the display

window. Each button can be set for SET 1 and SET 2 in both AM and FM. This allows a total of 12 AM, 12 FM, and 12 Satellite (if equipped) stations to be stored into push-button memory. The stations stored in SET 2 memory can be selected by pressing the push-button twice.

Every time a preset button is used, a corresponding button number will display.

Buttons 1 - 6 (Radio Mode)

These buttons tune the Radio to the stations that you commit to push-button memory {12 AM, 12 FM, and 12 Satellite (if equipped) stations}.

DISC Button

Pressing the DISC button will allow you to switch from AM/FM modes to Disc modes.

Operation Instructions - (DISC MODE for CD and MP3/WMA Audio Play, DVD-VIDEO)

The radio DVD player and many DVD discs are coded by geographic region. These region codes must match in order for the disc to play. If the region code for the DVD disc does not match the region code for the radio DVD player, it will not play the disc. Customers may take their vehicle to an authorized dealer to change the region code of the player a maximum of 5 times.

CAUTION!

The radio may shut down during extremely hot conditions. When this occurs, the radio will indicate "Disc Hot" and shut off until a safe temperature is reached. This shutdown is necessary to protect the optics of the DVD player and other radio internal components.

NOTE: The ignition switch must be in the ON or ACC position to operate the radio.

LOAD Button — Loading Compact Disc(s)

Press the LOAD button and the push-button with the corresponding number (1-6) where the CD is being loaded. The radio will display PLEASE WAIT and prompt when to INSERT DISC. After the radio displays "INSERT DISC," insert the CD into the player.

Radio display will show "LOADING DISC" when the disc is loading and "READING DISC" when the radio is reading the disc.

CAUTION!

- **This CD player will accept 4 3/4 inch (12 cm) discs only. The use of other sized discs may damage the CD player mechanism.**

Eject Button — Ejecting Compact Disc(s)



Press the eject button and the push-button with the corresponding number (1-6) where the CD was loaded and the disc will unload and move to the entrance for easy removal. Radio display will show "EJECTING DISC" when the disc is being ejected and prompt the user to remove the disc.

Press and hold the eject button for 5 seconds and all CDs will be ejected from the radio.

The disc can be ejected with the radio and ignition OFF.

SEEK Button (CD MODE)

Press the right SEEK button for the next selection on the CD. Press the left SEEK button to return to the beginning of the current selection, or return to the beginning of the previous selection if the CD is within the first second of the current selection. Pressing and holding the SEEK button will allow to scroll through tracks faster in CD, MP3/MWA modes.

SCAN Button (CD MODE)

Press the Scan button to scan through each track on the CD currently playing.

TIME Button (CD MODE)

Press this button to change the display from a large CD playing time display to a small CD playing time display.

RW/FF (CD MODE)

Press and hold FF (Fast Forward) and the CD player will begin to fast forward until FF is released or RW or another CD button is pressed. The RW (Reverse) button works in a similar manner.

AM or FM Button (CD MODE)

Switches the Radio to the Radio mode.

Notes On Playing MP3/WMA Files

The radio can play MP3/WMA files; however, acceptable MP3/WMA file recording media and formats are limited. When writing MP3/WMA files, pay attention to the following restrictions.

Supported Media (Disc Types)

The MP3/WMA file recording media supported by the radio are CDDA, CD-R, CD-RW, MP3,WMA, DVD Video, DVD-R, DVD-RW, DVD+R, DVD+RW, and CDDA+MP3.

Supported Medium Formats (File Systems)

The medium formats supported by the radio are ISO 9660 Level 1 and Level 2 and includes the Joliet extension. When reading discs recorded using formats other than ISO 9660 Level 1 and Level 2, the radio may fail to read files properly and may be unable to play the file normally. UDF and Apple HFS formats are not supported.

The radio uses the following limits for file systems:

- Maximum number of directory levels: 8
- Maximum number of files: 255
- Maximum number of folders: 100
- Maximum number of characters in file/folder names:
 - Level 1: 12 (including a separator "." and a 3-character extension)
 - Level 2: 31 (including a separator "." and a 3-character extension)

Multisession disc formats are supported by the radio. Multisession discs may contain combinations of normal CD audio tracks and computer files (including MP3/WMA files). Discs created with an option such as "keep disc open after writing" are most likely multisession discs. The use of multisession for CD audio or MP3/WMA playback may result in longer disc loading times.

If a disc contains multi formats, such as CD audio and mp3/wma tracks, the radio will only play the mp3/wma tracks on that disc.

Supported MP3/WMA File Formats

The radio will recognize only files with the *.MP3/WMA extension as MP3/WMA files. Non-MP3/WMA files named with the *.MP3/WMA extension may cause playback problems. The radio is designed to recognize the file as an invalid MP3/WMA and will not play the file.

When using the MP3/WMA encoder to compress audio data to an MP3/WMA file, the bit rate and sampling frequencies in the following table are supported. In addition, variable bit rates (VBR) are also supported. The majority of MP3/WMA files use a 44.1 kHz sampling rate and a 192, 160, 128, 96 or VBR bit rates.

MPEG Specification	Sampling Frequency (kHz)	Bit rate (kbps)
MPEG-1 Audio Layer 3	48, 44.1, 32	320, 256, 224, 192, 160, 128, 112, 96, 80, 64, 56, 48
MPEG-2 Audio Layer 3	24, 22.05, 16	160, 128, 144, 112, 96, 80, 64, 56, 48

WMA Specification	Sampling Frequency (kHz)	Bit Rate (kbps)
WMA	44.1 and 48	48, 64, 96, 128, 160, 192 VBR

ID3 Tag information for artist, song title, and album title are supported for version 1 ID3 tags. ID3 version 2 is not supported by the radios.

Playlist files are not supported. MP3 Pro files are not supported.

Playback of MP3/WMA Files

When a medium containing MP3/WMA data is loaded, the radio checks all files on the medium. If the medium contains a lot of folders or files, the radio will take more time to start playing the MP3/WMA files.

Loading times for playback of MP3/WMA files may be affected by the following:

- Media - CD-RW media may take longer to load than CD-R media
- Medium formats - Multisession discs may take longer to load than non-multisession discs
- Number of files and folders - Loading times will increase with more files and folders

To increase the speed of disc loading, it is recommended to use CD-R media and single-session discs. To create a single-session disc, enable the Disc at Once option before writing to the disc.

LIST Button (DISC Mode for MP3/WMA Play)

Pressing the LIST button will bring up a list of all folders on the disc. Scrolling up or down the list is done by turning the TUNE control knob. Selecting a folder by pressing the TUNE control knob will begin playing the files contained in that folder (or the next folder in sequence if the selection does not contain playable files).

The folder list will time out after 5 seconds.

INFO Button (DISC Mode for MP3/WMA Play)

Pressing the INFO button repeatedly will scroll through the following TAG information: Song Title, Artist, File Name, and Folder Name (if available).

Press the INFO button once more to return to "elapsed time" priority mode.

Press and hold the INFO button for 3 seconds or more and radio will display song titles for each file.

Press and hold the INFO button again for 3 seconds to return to "elapsed time" display.

Operation Instructions - Auxiliary Mode

The auxiliary (AUX) jack is an audio input jack, which allows the user to plug in a portable device such as an MP3/WMA player, cassette player, or microphone and utilize the vehicle's audio system to amplify the source and play through the vehicle speakers.

Pushing the AUX button will change the mode to auxiliary device if the AUX jack is connected.

NOTE: The AUX device must be turned on and the device's volume set to proper level. If the AUX audio is not loud enough, turn the device's volume up. If the AUX audio sounds distorted, turn the device's volume down.

SEEK Button (Auxiliary Mode)

No function.

SCAN Button (Auxiliary Mode)

No function.

EJECT Button (Auxiliary Mode)

No function.



TIME Button (Auxiliary Mode)

Press this button to change the display from elapsed playing time to time of day. The time of day will display for 5 seconds.

RW/FF (Auxiliary Mode)

No function.

SET Button (Auxiliary Mode)

No function.

Operating Instructions - Hands Free Phone (UConnect™) (If Equipped)

Refer to “Hands-Free Communication (UConnect™)” in Section 3 of this manual.

Operating Instructions - Satellite Radio Mode (If Equipped)

Refer to “Satellite Radio” in this section.

Operating Instructions - Video Entertainment System (VES®) (If Equipped)

Refer to separate “Video Entertainment System (VES®) Guide.”

Dolby

Manufactured under license from Dolby Laboratories. “Dolby” and the double-D symbol are trademarks of Dolby Laboratories.

Macrovision

This product incorporates copyright protection technology that is protected by U.S. patents and other intellectual property rights. Use of this copyright protection technology must be authorized by Macrovision, and is intended for home and other limited viewing uses only unless otherwise authorized by Macrovision. Reverse engineering or disassembly is prohibited

DTS

"DTS" and "DTS 2.0" are trademarks of Digital Theater Systems, Inc.

SALES CODE RES — AM/FM STEREO RADIO WITH CD PLAYER (MP3 AUX JACK)

NOTE: The radio sales code is located on the lower right side of your radio faceplate.

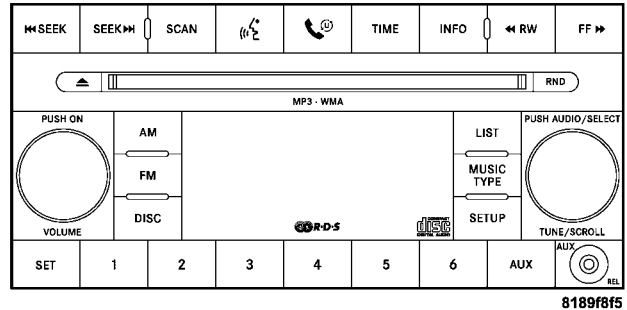

4

RES Radio (Non-Satellite Model Shown - With Satellite Similar)

Operating Instructions - Radio Mode

NOTE: The ignition switch must be in the ON or ACC position to operate the radio.

Power Switch/Volume Control (Rotary)

Press the ON/VOLUME control knob to turn on the radio. Press the ON/VOLUME control knob a second time to turn off the radio.

Electronic Volume Control

The electronic volume control turns continuously (360 degrees) in either direction without stopping. Turning the ON/VOLUME control knob to the right increases the volume and to the left decreases it.

When the audio system is turned on, the sound will be set at the same volume level as last played.

SEEK Buttons

Press and release the SEEK buttons to search for the next listenable station in AM/FM mode. Press the right switch to seek up and the left switch to seek down. The radio will remain tuned to the new station until you make another selection. Holding either button will bypass stations without stopping until you release it.

SCAN Button

Pressing the SCAN button causes the tuner to search for the next listenable station in AM or FM frequencies, pausing for 5 seconds at each listenable station before continuing to the next. To stop the search, press the SCAN button a second time.

Voice Recognition Button (UConnect™ Hands Free Phone) — If Equipped

Press this button to operate the Hand Free Phone (UConnect™) feature (if equipped). Refer to “Hands-Free Communication (UConnect™)” in Section 3 for more information.

If your vehicle is not equipped with or this feature is not available on your vehicle, a “Not Equipped With UConnect” message will display on the radio screen.

Phone Button (UConnect™ Hands Free Phone) — If Equipped

Press this button to operate the Hand Free Phone (UConnect™) feature (if equipped). Refer to “Hands-Free Communication (UConnect™)” in Section 3 for more information.

If your vehicle is not equipped with or this feature is not available on your vehicle, a “Not Equipped With UConnect” message will display on the radio screen.

TIME Button

Press the TIME button and the time of day will display. In AM or FM mode, pressing the TIME button will switch between the time and frequency displays.

Clock Setting Procedure

1. Press and hold the TIME button, until the hours blink.
2. Adjust the hours by turning the right side TUNE control knob.

3. After adjusting the hours, press the right side TUNE control knob to set the minutes. The minutes will begin to blink.

4. Adjust the minutes using the right side TUNE control knob. Press the TUNE control knob to save time change.

5. To exit, press any button/knob or wait 5 seconds.

The clock can also be set by pressing the SETUP button. For vehicles equipped with satellite radio, press the SETUP button, use the TUNE control to select SET CLOCK, and then follow the above procedure, starting at Step 2. For vehicles not equipped with satellite radio, press the SETUP button and then follow the above procedure, starting at Step 2.

INFO Button

Press the INFO button for an RDS station (one with call letters displayed). The radio will return a Radio Text message broadcast from an FM station (FM mode only).

RW/FF

Pressing the RW (Rewind) or FF (Fast Forward) buttons causes the tuner to search for the next frequency in the direction of the arrows. This feature operates in either AM or FM frequencies.

TUNE Control

Turn the right side rotary control clockwise to increase or counter-clockwise to decrease the frequency.

Setting the Tone, Balance, and Fade

Press the rotary TUNE control knob and BASS will display. Turn the TUNE control knob to the right or left to increase or decrease the Bass tones.

Press the rotary TUNE control knob a second time and MID will display. Turn the TUNE control knob to the right or left to increase or decrease the Mid Range tones.

Press the rotary TUNE control knob a third time and TREBLE will display. Turn the TUNE control knob to the right or left to increase or decrease the Treble tones.

Press the rotary TUNE control knob a fourth time and BALANCE will display. Turn the TUNE control knob to the right or left to adjust the sound level from the right or left side speakers.

Press the rotary TUNE control knob a fifth time and FADE will display. Turn the TUNE control knob to the left or right to adjust the sound level between the front and rear speakers.

Press the rotary TUNE control knob again to exit setting tone, balance, and fade.

MUSIC TYPE Button

Pressing this button once will turn on the Music Type mode for 5 seconds. Pressing the Music Type button or turning the TUNE control knob within 5 seconds will allow the

program format type to be selected. Many radio stations do not currently broadcast Music Type information.

Toggle the Music Type button to select the following format types:

Program Type	16 Digit-Character Display
No program type or undefined	None
Adult Hits	Adlt Hit
Classical	Classicl
Classic Rock	Cls Rock
College	College
Country	Country
Foreign Language	Language
Information	Inform
Jazz	Jazz
News	News

Program Type	16 Digit-Character Display
Nostalgia	Nostalgia
Oldies	Oldies
Personality	Persnlty
Public	Public
Rhythm and Blues	R & B
Religious Music	Rel Musc
Religious Talk	Rel Talk
Rock	Rock
Soft	Soft
Soft Rock	Soft Rck
Soft Rhythm and Blues	Soft R&B
Sports	Sports
Talk	Talk
Top 40	Top 40
Weather	Weather

By pressing the SEEK button when the Music Type icon is displayed, the radio will be tuned to the next frequency station with the same selected Music Type name. The Music Type function only operates when in the FM mode.

If a preset button is activated while in the Music Type (Program Type) mode, the Music Type mode will be exited and the radio will tune to the preset station.

SETUP Button

Pressing the SETUP button allows you to select between the following items:

- **Set Clock** — Pressing the SELECT button will allow user to set the clock. Turn the TUNE control knob to adjust the hours and then press and turn the TUNE control knob to adjust the minutes. Press the TUNE control knob again to save changes.

AM and FM Buttons

Press the buttons to select AM or FM Modes.

SET Button — To Set the Push-Button Memory

When you are receiving a station that you wish to commit to push-button memory, press the SET button. The symbol SET 1 will now show in the display window. Select the button (1-6) you wish to lock onto this station and press and release that button. If a button is not selected within 5 seconds after pressing the SET button, the station will continue to play but will not be stored into push-button memory.

You may add a second station to each push-button by repeating the above procedure with this exception: Press the SET button twice and SET 2 will show in the display window. Each button can be set for SET 1 and SET 2 in both AM and FM. This allows a total of 12 AM and 12 FM

stations to be stored into push-button memory. The stations stored in SET 2 memory can be selected by pressing the push-button twice.

Every time a preset button is used, a corresponding button number will display.

Buttons 1 - 6

These buttons tune the radio to the stations that you commit to push-button memory {12 AM and 12 FM stations}.

DISC Button

Pressing the DISC button will allow you to switch from AM/FM modes to Disc modes.

Operation Instructions - CD MODE for CD and MP3 Audio Play

NOTE: The ignition switch must be in the ON or ACC position to operate the radio.

NOTE: This Radio is capable of playing compact discs (CD), recordable compact discs (CD-R), rewritable compact discs (CD-RW) compact discs with MP3 tracks and multisession compact discs with CD and MP3 tracks.

Inserting Compact Disc(s)

Gently insert one CD into the CD player with the CD label facing up. The CD will automatically be pulled into the CD player and the CD icon will illuminate on the radio display. If a CD does not go into the slot more than an inch, a disc may already be loaded and must be ejected before a new disc can be loaded.

If you insert a disc with the ignition ON and the radio ON, the unit will switch from radio to CD mode and begin to play when you insert the disc. The display will show the disc number, the track number, and index time in minutes and seconds. Play will begin at the start of track 1.

CAUTION!

- **This CD player will accept 4 3/4 inch (12 cm) discs only. The use of other sized discs may damage the CD player mechanism.**
- **Do not use adhesive labels. These labels can peel away and jam the player mechanism.**
- **RES is a single CD player. Do not attempt to insert a second CD if one is already loaded.**
- **Dual-media disc types (one side is a DVD, the other side is a CD) should not be used, and they can cause damage to the player.**

EJECT Button - Ejecting a CD

Press the EJECT button to eject the CD.



If you have ejected a disc and have not removed it within 10 seconds, it will be reloaded. If the CD is not removed, the radio will reinsert the CD but will not play it.

A disc can be ejected with the radio and ignition OFF.

NOTE: Ejecting with ignition OFF is not allowed on convertible or soft-top models (if equipped).

SEEK Button

Press the right SEEK button for the next selection on the CD. Press the left SEEK button to return to the beginning of the current selection, or return to the beginning of the previous selection if the CD is within the first second of the current selection. Pressing and holding the SEEK button will allow to scroll through tracks faster in CD, MP3 modes.

SCAN Button

Press the Scan button to scan through each track on the CD currently playing.

TIME Button

Press this button to change the display from a large CD playing time display to a small CD playing time display.

RW/FF

Press the RW button to stop the CD at the beginning of the current CD track/title.

Press and hold FF (Fast Forward) and the CD player will begin to fast forward until FF is released or RW or another CD button is pressed. The RW (Reverse) button works in a similar manner.

AM or FM Button

Switches the Radio to the Radio mode.

RND Button (Random Play Button)

Press this button while the CD is playing to activate Random Play. This feature plays the selections on the compact disc in random order to provide an interesting change of pace.

Press the right SEEK button to move to the next randomly selected track.

Press the RND button a second time to stop Random Play.

Notes On Playing MP3 Files

The radio can play MP3 files; however, acceptable MP3 file recording media and formats are limited. When writing MP3 files, pay attention to the following restrictions.

Supported Media (Disc Types)

The MP3 file recording media supported by the radio are CDDA, CD-R, CD-RW, MP3, and CDDA+MP3.

Supported Medium Formats (File Systems)

The medium formats supported by the radio are ISO 9660 Level 1 and Level 2 and includes the Joliet extension. When reading discs recorded using formats other than ISO 9660 Level 1 and Level 2, the radio may fail to read

files properly and may be unable to play the file normally. UDF and Apple HFS formats are not supported.

The radio uses the following limits for file systems:

- Maximum number of folder levels: 8
- Maximum number of files: 255
- Maximum number of folders (The radio display of file names and folder names is limited. For large numbers of files and/or folders, the radio may be unable to display the file name and folder name and will assign a number instead. With a maximum number of files, exceeding 20 folders will result in this display. With 200 files, exceeding 50 folders will result in this display.
- Maximum number of characters in file/folder names:
 - Level 1: 12 (including a separator "." and a 3-character extension)
 - Level 2: 31 (including a separator "." and a 3-character extension)

Multisession disc formats are supported by the radio. Multisession discs may contain combinations of normal CD audio tracks and computer files (including MP3 files). Discs created with an option such as "keep disc open after writing" are most likely multisession discs. The use of multisession for CD audio or MP3 playback may result in longer disc loading times.

Supported MP3 File Formats

The radio will recognize only files with the *.MP3 extension as MP3 files. Non-MP3 files named with the *.MP3 extension may cause playback problems. The radio is designed to recognize the file as an invalid MP3 and will not play the file.

When using the MP3 encoder to compress audio data to an MP3 file, the bit rate and sampling frequencies in the following table are supported. In addition, variable bit

rates (VBR) are also supported. The majority of MP3 files use a 44.1 kHz sampling rate and a 192, 160, 128, 96 or VBR bit rates.

MPEG Specification	Sampling Frequency (kHz)	Bit Rate (kbps)
MPEG-1 Audio Layer 3	48, 44.1, 32	320, 256, 224, 192, 160, 128, 112, 96, 80, 64, 56, 48, 40, 32
MPEG-2 Audio Layer 3	24, 22.05, 16	160, 128, 144, 112, 96, 80, 64, 56, 48, 40, 32, 24, 16, 8

ID3 Tag information for artist, song title, and album title are supported for version 1 ID3 tags. ID3 version 2 is not supported by the radios.

Playlist files are not supported. MP3 Pro files are not supported.

Playback of MP3 Files

When a medium containing MP3 data is loaded, the radio checks all files on the medium. If the medium contains a lot of folders or files, the radio will take more time to start playing the MP3 files.

Loading times for playback of MP3 files may be affected by the following:

- Media - CD-RW media may take longer to load than CD-R media
- Medium formats - Multisession discs may take longer to load than non-multisession discs
- Number of files and folders - Loading times will increase with more files and folders

To increase the speed of disc loading, it is recommended to use CD-R media and single-session discs. To create a single-session disc, enable the Disc at Once option before writing to the disc.

LIST Button (CD Mode for MP3 Play)

Pressing the LIST button will bring up a list of all folders on the disc. Scrolling up or down the list is done by turning the TUNE control knob. Selecting a folder by pressing the TUNE control knob will begin playing the files contained in that folder (or the next folder in sequence if the selection does not contain playable files).

The folder list will time out after 5 seconds.

INFO Button (CD Mode for MP3 Play)

Pressing the INFO button repeatedly will scroll through the following TAG information: Song Title, Artist, File Name, and Folder Name (if available).

Press the INFO button once more to return to "elapsed time" priority mode.

Press and hold the INFO button for 3 seconds or more and radio will display song titles for each file.

Press and hold the INFO button again for 3 seconds to return to "elapsed time" display.

Operation Instructions - Auxiliary Mode

The auxiliary (AUX) jack is an audio input jack, which allows the user to plug in a portable device such as an MP3 player, or cassette player, and utilize the vehicle's audio system to amplify the source and play through the vehicle speakers.

Pushing the AUX button will change the mode to auxiliary device if the AUX jack is connected.

NOTE: The AUX device must be turned on and the device's volume set to proper level. If the AUX audio is not loud enough, turn the device's volume up. If the AUX audio sounds distorted, turn the device's volume down.

TIME Button (Auxiliary Mode)

Press this button to change the display to time of day. The time of day will display for 5 seconds (when ignition is off).

Operating Instructions - Hands Free Phone (UConnect™) (If Equipped)

Refer to “Hands-Free Communication (UConnect™)” in Section 3 of this manual.

Operating Instructions - Satellite Radio Mode (If Equipped)

Refer to “Satellite Radio” in this section.

Operating Instructions - Video Entertainment System (VES®) (If Equipped)

Refer to separate “Video Entertainment System (VES®) Guide.”

SALES CODE REN — MULTIMEDIA SYSTEM — IF EQUIPPED

NOTE: The sales code is located on the lower right side of the unit’s faceplate.

The REN multimedia system contains a radio, CD/DVD player, USB port, a 20 gigabyte Hard Drive (HDD), and a “JukeBox” (virtual CD changer). Sirius Satellite Radio is optional. The 6.5-inch touch screen allows for easy menu selection.

A 20 gigabyte Hard Drive (HDD) allows uploads of music and photos from CDs or through the USB port. While the Gracenote database finds the artist, track, and title for the music.

An auxiliary input jack permits passengers to listen to a portable MP3 player through the vehicle’s speakers. For vehicles equipped with the Vehicle Entertainment System (VES), separate audio outputs allow passengers to listen

to the car speakers while different audio tracks play through the system's wireless headphones. This means rear seat passengers can watch a DVD on the optional rear-seat entertainment system while the driver and front seat passenger listen to the radio.

Other special features include direct tune, music type selections, easy store presets, backup camera display for vehicles equipped with a backup camera, and on some models a dual display screen operation. Refer to your Radio Specific User's Manual for detailed operating instructions.

Operating Instructions — Satellite Radio (If Equipped)

Refer to your Radio Specific User's Manual for detailed operating instructions.

Operating Instructions — Hands-Free Communication (UConnect™) (If Equipped)

Refer to “Hands-Free Communication (UConnect™)” in Section 3 of this manual for detailed operating instructions.

Clock Setting Procedure

Setting the Clock

1. Turn on the system.
2. Touch the screen where the time is displayed. The clock setting menu will appear on the screen.
3. To move the hour forward, touch the screen where the word “Hour” with the arrow pointing upward is displayed. To move the hour backward, touch the screen where the word “Hour” with the arrow pointing downward is displayed.

4. To move the minute forward, touch the screen where the word “Min” with the arrow pointing upward is displayed. To move the minute backward, touch the screen where the word “Min” with the arrow pointing downward is displayed.
5. To save the new time setting, touch the screen where the word “Save” is displayed.

Changing Daylight Savings Time

When selected, this feature will display the time of day in daylight savings time. Proceed as follows to change the current setting:

1. Turn on the system.
2. Touch the screen where the time is displayed. The clock setting menu will appear on the screen.

3. When this feature is on, a check mark will appear in the box next to the words “Daylight Savings.” Touch the screen where the words “Daylight Savings” are displayed to change the current setting.

Show Time if Radio is Off

When selected, this feature will display the time of day on the touch screen when the system is turned off. Proceed as follows to change the current setting:

1. Turn on the system.
2. Touch the screen where the time is displayed. The clock setting menu will appear on the screen.
3. When this feature is on, a check mark will appear in the box next to the words “Show Time if Radio is Off.” Touch the screen where the words “Show Time if Radio is Off” are displayed to change the current setting.

Changing the Time Zone

1. Turn on the system.
2. Touch the screen where the time is displayed. The clock setting menu will appear on the screen.
3. Touch the screen where the words “Set Time Zone” are displayed. The time zone selection menu will appear on the screen.
4. Select a time zone by touching the screen where your selection appears. If you do not see a time zone that you want to select, touch the screen where the word “Page” is displayed to view additional time zones in the menu.
5. Touch the screen where the word “Save” is displayed.

SALES CODE RER — AM/FM/CD/DVD RADIO WITH NAVIGATION SYSTEM — IF EQUIPPED

NOTE: The radio sales code is located on the lower right side of your radio faceplate.

Satellite Navigation Radio with CD Player with MP3 Capability (RER) - combines a Global-Positioning System-based navigation system with an integrated color screen to provide maps, turn identification, selection menus, and instructions for selecting a variety of destinations and routes.

This radio has a hard drive. CD's can be ripped to the hard drive, and the map data comes loaded on the hard drive. Refer to your “Navigation User's Manual” for detailed operating instructions.

Operating Instructions — Satellite Radio

Refer to your “Navigation User’s Manual” for detailed operating instructions.

Clock Setting Procedure

The GPS receiver used in this system is synchronized to the time data being transmitted by the GPS satellite. The satellites’ clock is Greenwich Mean Time (GMT). This is the worldwide standard for time. This makes the system’s clock very accurate once the appropriate time zone and daylight savings information is set.

To Manually Set the Clock

1. Turn the ignition switch to the ON or ACC position.
2. If the radio is off, turn it on by pressing the ON/OFF Volume radio knob.
3. Press the **Time** soft key on the lower left side of the face of the radio.

4. Press the **HOUR** or **MIN** soft keys on the face of the radio.
5. The time setting will change each time you press the HOUR or MIN soft key.
6. Press the **SAVE** soft key on the face of the radio.

Changing the Time Zone

1. Press the **Time** soft key on the lower left side of the face of the radio.
2. Press the **Set Time Zone** soft key on the face of the radio.
3. Select the appropriate time zone for your location, and press the **SAVE** soft key to store your selection.

NOTE: When you are traveling and enter a new time zone, the clock must be reset manually for the new zone.

Changing Daylight Savings Time

1. Press the **Time** soft key on the lower left side of the face of the radio.
2. Press the **Daylight Savings** soft key when Daylight Savings Time is in effect.
3. Press the **SAVE** soft key on the face of the radio.

Press the **CANCEL** soft key to exit from the clock setting mode.

UNIVERSAL CONSUMER INTERFACE (UCI) — IF EQUIPPED

NOTE: This section is for sales code RES and REQ radios only with UConnect.TM For sales code REN touch screen radio, refer to the separate User's Manual.

This feature allows you to plug in an iPod® into the vehicle's sound system through a connector (UCI connector) using an optional connection cable (available through Mopar®). See your authorized dealer for details.

Using this feature,

- the iPod® audio can be played on the vehicle's sound system, providing metadata (Track Title, Artist, Album, etc.) information display on radio.
- the iPod® can be controlled using the radio buttons to Play, Browse and List the iPod® contents.
- the iPod® battery charges when plugged into the UCI connector.

Connecting the iPod®

Use the optional connection cable to connect an iPod® to the vehicle's UCI connector (which is located in the glove box on some vehicles. This location may vary with vehicle). Once the iPod® is connected and synchronized to the vehicle system (this may take a few seconds to connect), the vehicle brand logo appears on the iPod® display, and it starts charging and is ready for use by pressing radio switches as described below.

Controlling the iPod® using Radio Buttons

To get into the UCI (iPod®) mode and access a connected iPod®, press the "AUX" button on the radio faceplate. Once in the UCI (iPod®) mode, the iPod® audio track (if available from iPod®) will start playing over the vehicle audio system.

Play Mode

When switched to UCI mode the iPod® will be in **Play mode**. In this **Play mode**, you may use the following buttons on the radio faceplate to control the iPod® and display data:

TUNE/SCROLL Knob

Use the "TUNE/SCROLL" knob to go to the next or previous track.

The "TUNE/SCROLL" knob functions similar to the scroll wheel on the iPod®.

Turning it clockwise (forward) by one click while playing a track skips to the next track.

Turning it counterclockwise (backward) by one click during the first 2 seconds of the track will jump to the previous track in the list and turning this button at any other time in the track will jump to the beginning of the current track.

RW (Rewind) Button

Press and hold the “RW” button to move backward in the current track. Holding the “RW” button long enough will take you back to the beginning of the current track.

Pressing and releasing the “RW” button will go back 5 seconds of the current track.

FF (Fast Forward) Button

Press and hold the “FF” button to move forward in the current track.

Pressing and releasing the “FF” button will go forward 5 seconds of the current track.

SEEK Buttons

Use the “SEEK” buttons to move to the previous or the next track.

If the left (down) button is pressed during the first 2 seconds of the current track, it will go back to the previous track in the list, if you press this button at any other time in the current track it will go back to the beginning of the track.

If the right (up) button is pressed during **Play** mode, it will go to the next track in the list.

INFO Button

Press the “INFO” button while a track is playing to see the information (Track Title, Artist, Album, etc.) for that track. Each press the “INFO” button will take you to the next screen of data for that track. Once you have seen all of the screens, the last press of the “INFO” button will take you back to the play mode screen on the radio.

REPEAT Button

Press the “REPEAT” button to repeat the current playing track

SCAN Button

Pressing the “SCAN” button will play the first 5 seconds of each track in the current list and then forward to the next song. To stop the SCAN mode and start playing the desired track, press the “SCAN” button again.

During the SCAN mode, you can also press the SEEK button to the left or right to go to the previous or next tracks.

RND (Random) Button (RES Radios Only)

Pressing the “RND” button will switch between the shuffle on and shuffle off modes of the iPod®. If the “RND” icon is showing on the radio display then the shuffle mode is on.

List or Browse Mode

During **Play** mode, pressing any of the following buttons will take you to **List** mode. **List** mode enables you to scroll through the list of menus and tracks on the iPod®.

TUNE/SCROLL Knob

In the **List** mode, the “TUNE/SCROLL” knob functions in a similar manner as the scroll wheel on the iPod®.

Turning the “TUNE/SCROLL” knob clockwise (forward) and counter-clockwise (backward) scrolls through lists, displaying the track detail on the radio display. Once you have the track to be played highlighted on the radio display, press the “TUNE/SCROLL” knob to select and start playing the track. By turning the “TUNE/SCROLL” knob fast, you can jump through the list faster. During fast scroll, you may notice a slight delay in updating the information on the radio display.

During all List modes, the iPod® will display all lists in “wrap-around” mode. So if the track you wish to select is at the bottom of the list, you just turn the “TUNE/SCROLL” knob backwards (counter-clockwise) to get to the track faster.

Radio Preset Buttons

In the **List** mode, the radio preset buttons are used as shortcuts to the following lists on the iPod®.

- 1 – Playlists
- 2 – Artists
- 3 – Albums
- 4 – Genres
- 5 – Audiobooks
- 6 – Podcasts

After pressing a preset button, you will see the list you are in on the top line and the first item in that list on the second line.

To exit the **List** mode without selecting a track, press the same preset button again to go back to **Play** mode.

LIST Button

Pressing the “LIST” button will take to the top level menu of the iPod®. This takes you to the same top level menu as on your iPod®. Turn the “TUNE/SCROLL” knob to list the top menu item you wish to select and then press the “TUNE/SCROLL” knob. This will take you to the next sub menu list item of the iPod® and you can follow the same the same steps to go to the desired track in that list. Not all iPod® sub menu levels are available on this system.

MUSIC TYPE Button

The “MUSIC TYPE” button is another shortcut button to the genre listing on your iPod®.

SATELLITE RADIO (RSC) — IF EQUIPPED (REQ AND RES RADIOS ONLY)

Satellite radio uses direct satellite to receiver broadcasting technology to provide clear digital sound, coast to coast. The subscription service provider is Sirius™ Satellite Radio. This service offers up to 100 channels of music, sports, news, entertainment, and programming for children, directly from its satellites and broadcasting studios.

System Activation

Sirius Satellite Radio service is pre-activated, and you may begin listening immediately to the one year of SIRIUS audio service that is included with the factory-installed satellite radio system in your vehicle. Sirius will contact you to supply a welcome kit and to confirm subscription information, including the set up of your on-line listening account at no additional charge. For

further information, call the toll-free number 888-539-7474, or visit the Sirius web site at www.sirius.com. Please have the following information available when calling:

1. The Electronic Serial Number/Sirius Identification Number (ESN/SID).
2. Your Vehicle Identification Number.

Electronic Serial Number/Sirius Identification Number (ENS/SID)

The Electronic Serial Number/Sirius Identification Number is needed to activate your Sirius Satellite Radio system. To access the ESN/SID, refer to the following steps:

ESN/SID Access

With the ignition switch in the ON/RUN or ACCESSORY position and the radio ON, press the SETUP button and scroll using the TUNE control knob until Sirius ID is

selected. Press the TUNE control knob and the Sirius ID number will display. The Sirius ID number display will time out in 2 minutes. Press any button on the radio to exit this screen.

Selecting Satellite Mode

Press the SAT button until "SAT" appears in the display. A CD may remain in the radio while in the Satellite radio mode.

Satellite Antenna

To ensure optimum reception, do not place items on the roof around the rooftop antenna location or strap items to the trunk lid around the trunk lid antenna (if equipped). Metal objects placed within the line of sight of the antenna will cause decreased performance. Larger luggage items such as bikes should be placed as far rearward as possible, within the loading design of the rack. Do not place items directly on or above the antenna.

Reception Quality

Satellite reception may be interrupted due to one of the following reasons:

- The vehicle is parked in an underground parking structure or under a physical obstacle.
- Dense tree coverage may interrupt reception in the form of short audio mutes.
- Driving under wide bridges or along tall buildings can cause intermittent reception.
- Placing objects over or too close to the antenna can cause signal blockage.

Operating Instructions - Satellite Mode

NOTE: The ignition switch must be in the ON or ACC position to operate the radio.

SEEK Buttons

Press and release the SEEK buttons to search for the next channel in Satellite mode. Press the right switch to seek up and the left switch to seek down. The radio will remain tuned to the new channel until you make another selection. Holding either button will bypass channels without stopping until you release it.

SCAN Button

Pressing the SCAN button causes the tuner to search for the next channel, pausing for 8 seconds before continuing to the next. To stop the search, press the SCAN button a second time.

INFO Button

Pressing the INFO button will cycle between Artist, Song Title, and Composer (if available) information. Also, pressing and holding the INFO button for an additional

3 seconds will make the radio display the Song Title all of the time (press and hold again to return to normal display).

RW/FF

Pressing the RW (Rewind) or FF (Fast Forward) buttons causes the tuner to search for the next channel in the direction of the arrows.

TUNE Control (Rotary)

Turn the right side rotary control clockwise to increase or counter-clockwise to decrease the channel.

MUSIC TYPE Button

Pressing this button once will turn on the Music Type mode for 5 seconds. Pressing the MUSIC TYPE button or turning the TUNE control knob within 5 seconds will allow the program format type to be selected.

Toggle the MUSIC TYPE button again to select the music type.

By pressing the SEEK button when the Music Type function is active, the radio will be tuned to the next channel with the same selected Music Type name.

If a preset button is activated while in the Music Type (Program Type) mode, the Music Type mode will be exited and the radio will tune to the preset channel.

SETUP Button

Pressing the SETUP button allows you to select the following items:

- Display Sirius ID number — Press the SELECT button to display the Sirius ID number. This number is used to activate, deactivate, or change the Sirius subscription.

SET Button — To Set the Push-Button Memory

When you are receiving a channel that you wish to commit to push-button memory, press the SET button. The symbol SET 1 will now show in the display window.

Select the button (1-6) you wish to lock onto this channel and press and release that button. If a button is not selected within 5 seconds after pressing the SET button, the channel will continue to play but will not be stored into push-button memory.

You may add a second channel to each push-button by repeating the above procedure with this exception: Press the SET button twice and SET 2 will show in the display window. Each button can be set for SET 1 and SET 2. This allows a total of 12 Satellite channels to be stored into push-button memory. The channels stored in SET 2 memory can be selected by pressing the push-button twice.

Every time a preset button is used, a corresponding button number will display.

Buttons 1 - 6

These buttons tune the radio to the channels that you commit to push-button memory {12 Satellite stations}.

Operating Instructions - Hands Free Phone (If Equipped)

Refer to “Hands-Free Communication (UConnect™)” in Section 3 of this manual.

Operating Instructions - Video Entertainment System (VES®) (If Equipped)

Refer to separate “Video Entertainment System (VES®) Guide.”

VIDEO ENTERTAINMENT SYSTEM (SALES CODE XRV) — IF EQUIPPED

The optional VES™ (Video Entertainment System) consists of a LCD (liquid crystal display) screen, a battery-powered remote control, and two headsets. Refer to your VES™ User’s Manual for detailed operating instructions.

The LCD screen is located on the headliner behind the front seats.

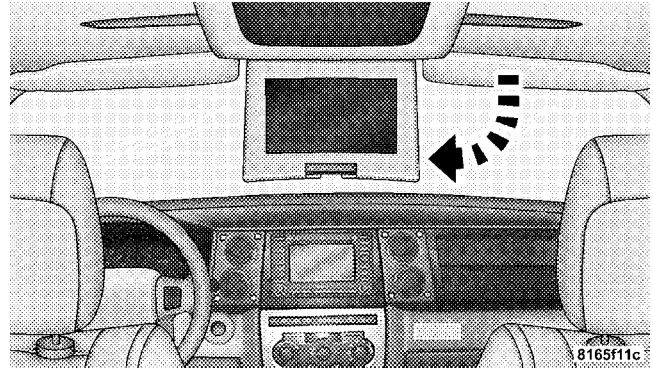

Lowering the Display Screen

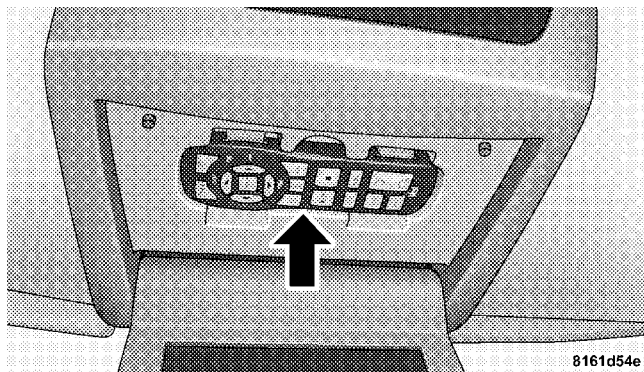

8161d54e

Remote Control Location

REMOTE SOUND SYSTEM CONTROLS — IF EQUIPPED

The remote sound system controls are located on the rear surface of the steering wheel. Reach behind the wheel to access the switches.

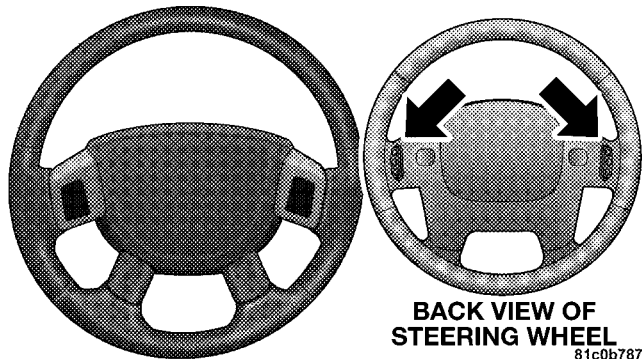

BACK VIEW OF STEERING WHEEL

81c0b787

The right hand control is a rocker type switch with a push-button in the center and controls the volume and mode of the sound system. Pressing the top of the rocker switch will increase the volume and pressing the bottom of the rocker switch will decrease the volume.

Pressing the center button will make the radio switch between the various modes available (AM/FM/TAPE/CD, Etc.).

The left hand control is a rocker type switch with a push-button in the center. The function of the left hand control is different depending on which mode you are in.

The following describes the left hand control operation in each mode.

Radio Operation

Pressing the top of the switch will “Seek” up for the next listenable station and pressing the bottom of the switch will “Seek” down for the next listenable station.

The button located in the center of the left hand control will tune to the next preset station that you have programmed in the radio preset push-button.

CD Player

Pressing the top of the switch once will go to the next track on the CD. Pressing the bottom of the switch once will go to the beginning of the current track or to the beginning of the previous track if it is within one second after the current track begins to play.

If you press the switch up or down twice it plays the second track, three times, it will play the third, etc.

The center button on the left side rocker switch has no function for a single disc CD player. However, when a multiple disc CD player is equipped on the vehicle, the center button will select the next available CD in the player.

CD/DVD DISC MAINTENANCE

To keep the CD/DVD discs in good condition, take the following precautions:

1. Handle the disc by its edge; avoid touching the surface.
2. If the disc is stained, clean the surface with a soft cloth, wiping from center to edge.
3. Do not apply paper, paper CD labels, or tape to the disc; avoid scratching the disc.
4. Do not use solvents such as benzine, thinner, cleaners, or antistatic sprays.

5. Store the disc in its case after playing.
6. Do not expose the disc to direct sunlight.
7. Do not store the disc where temperatures may become too high.

RADIO OPERATION AND CELLULAR PHONES

Under certain conditions, the cellular phone being On in your vehicle can cause erratic or noisy performance from your radio. This condition may be lessened or eliminated by relocating the cellular phone antenna. This condition is not harmful to the radio. If your radio performance does not satisfactorily “clear” by the repositioning of the antenna, it is recommended that the radio volume be turned down or off during cellular phone operation.

CLIMATE CONTROLS

Manual Air Conditioning and Heating System — If Equipped

The controls for the heating/air conditioning and ventilation system in this vehicle consist of a series of rotary knobs. These comfort controls can be set to obtain desired interior conditions.

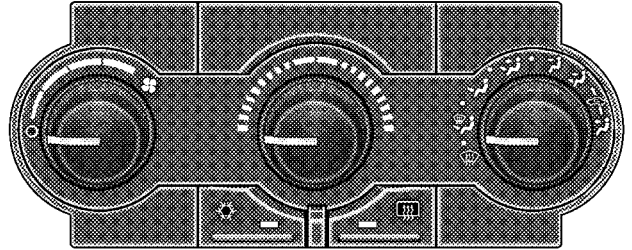

81350206

Manual Air Conditioning and Heating Controls

The instrument panel features four dual-vane airflow registers. Two registers are located on the outer ends of the instrument panel and two are located in the center of the instrument panel. These registers can be closed to partially block airflow, and they can be adjusted to direct airflow where the occupant desires.

Blower Control



812d1942

The rotary knob on the left controls the blower and can be set in one of four speeds and OFF. **The blower fan motor will remain on until the system is turned to the OFF position or the ignition is turned OFF.**

Temperature Control



812d193c

The temperature of air can be selected by rotating the center temperature control knob. The coldest temperature setting is on the extreme left and the warmest setting on the extreme right of the rotation. The knob can be positioned at any point on the dial.

Mode Control



812d192f

The mode selector (the right rotary knob) can be placed in several positions. Dots between each of the mode selections identify intermediate modes that allow the occupants to fine tune airflow distribution.

Defrost



Air is directed to the windshield through the outlets at the base of the windshield. Air is also directed to the front door windows through the side window demister grilles. Some airflow is delivered to the floor while in defrost so that comfort can be maintained.

Defrost/Floor



Air flows through the front and rear floor outlets and the outlets at the base of the windshield. Air is also directed to the front door windows through the

side window demister grilles. Some airflow is delivered to the floor while in defrost so that comfort can be maintained.

Floor

 Air flows through the floor outlets located under the instrument panel and into the rear seating area through vents under the front seats. Some airflow is delivered to defrost while in the floor mode so that comfort can be maintained.

Bi-Level

 Air flows both through the outlets located in the instrument panel and those located on the floor. Air flows through the registers in the back of the center console, and under the front seats to the rear seat passengers. These registers can be closed to partially block airflow. The center console outlets deliver conditioned air while the floor outlets deliver heated air.

Panel

 Air flows through the outlets located in the instrument panel. Air flows through the registers in the back of the center console to the rear seat passengers. These registers can be closed to block airflow.

Recirculation

 The recirculation feature can be selected with the mode control knob. You may choose between Bi-Level Recirculation and Panel Recirculation air outlets while in this mode. Normally, air enters from outside the vehicle. However, when in Recirculation mode air inside the vehicle is re-used. Use this mode to rapidly cool the inside of the vehicle. The Recirculation mode can also be used to temporarily block out outside odors, smoke, and dust.

Air Conditioning Operation

 To turn on the Air Conditioning, set the fan control at any speed and press the snowflake button

located on the control panel. Conditioned air will be directed through the outlets selected by the mode control. A light in the snowflake button shows that the air conditioning is on.

Slight changes in engine speed or power may be noticed when the air conditioning compressor is on. This is a normal occurrence as the compressor will cycle on and off to maintain comfort and increase fuel economy.

Automatic Temperature Control — If Equipped

The Infrared Dual-Zone Climate Control System automatically maintains the interior comfort level desired by the driver and passenger. This is accomplished by a dual sun-sensor in the top of the instrument panel, and an infrared sensor located in the face of the control unit. There are also various sensors monitored by this system which take account for vehicle speed, A/C pressure, outside temperature, and engine cooling temperature. The infrared sensor independently measures the surface

temperature of the driver and passenger. Based on the sensor input, the system automatically adjusts the air flow temperature, the air flow volume, and amount of outside air recirculation. This maintains a comfortable temperature even under changing conditions.

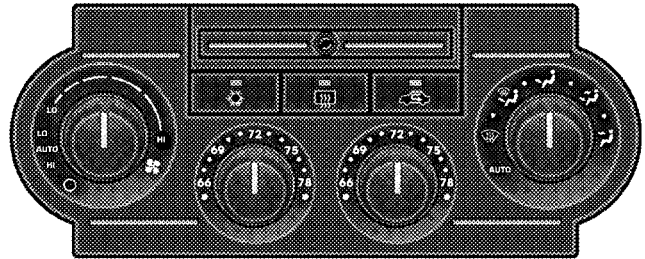

8135020a

Automatic Temperature Controls

NOTE: The numbers on the temperature dial represent a comfort setting when the Mode knob is set to Auto, and not the actual air temperature.

Operation of the system is quite simple. Begin by turning the right mode knob to AUTO, and place the blower control (left knob) to either LO AUTO or HI AUTO. The LO AUTO position should be used for front seat occupants only. The HI AUTO position should be used when more air flow is desired, or when rear seat occupants are present. Dial in the comfort setting you would like the system to maintain by rotating the driver's or passenger's control knob. Once the comfort level is selected the system will maintain that level automatically using the heating system. Should the desired comfort level require air conditioning, the system will automatically make the adjustment.

You will experience the greatest efficiency by simply allowing the system to function automatically. Selecting the OFF position on the fan control stops the system completely.

NOTE: The temperature setting can be adjusted at any time without affecting automatic control operation. However, if the driver and/or passenger temperature knobs are set to the full hot or full cold positions, the air temperature out of the ducts will be full hot or full cold respectively. With the temperature setting in these positions, the system does not attempt automatic comfort control.



The air conditioning in this system is automatic. Pressing this button while in AUTO mode will cause the LED to flash three times and remain off. This indicates that the system is in AUTO and requesting the air conditioning is not necessary.



The system will automatically control recirculation. However, pressing this button will temporarily put the system in recirculation mode.

This can be used when outside conditions such as smoke, odors, dust, or high humidity are present. This will cause the LED to illuminate.

NOTE:

- The surface of the climate control panel, and the top center of the instrument panel should be kept free of debris due to the climate control sensor's location. Mud on the windshield may also cause poor operation of this system.
- To provide you with maximum comfort in the automatic mode, during cold start-ups the blower fan will remain off until the engine warms up. However, the fan will engage immediately if the defrost mode is selected or if you manually select a blower speed.

- Under certain conditions (after the vehicle is turned off) the climate control system may recalibrate and a noise may be heard for 20 seconds. This is part of normal operation.
- Most of the time, when in Automatic operation, you can temporarily put the system into recirculation mode by pressing the Recirc button. However, under certain conditions in automatic the system is blowing air out of the defrost vents. When these conditions are present and the Recirc button is pressed the indicator will flash and remain off. This tells you that you are unable to go into recirculation mode at this time. If you would like to go to Recirculation mode, you must first move your mode knob to panel, panel/floor or floor, then hit the Recirc button. This feature will reduce the possibility of window fogging.

Manual Operation

This system offers a full complement of manual override features which consist of Blower Preferred Automatic, Mode Preferred Automatic with Manual Air Temperature Control and Manual. This means the customer can override the blower, mode and disable automatic temperature control completely.

NOTE: Please read the Automatic Temperature Control Operation Chart below for details.

264 UNDERSTANDING YOUR INSTRUMENT PANEL

Automatic Temperature Control Operation		The System will...				
Operation	How	Blower Control	Mode Control	Air Temperature Control	Air Recirculation Control	A/C Operation
Full Automatic Operation	Set blower knob to either Hi or Lo Auto. Set temperature knobs for Comfort.	Automatic	Automatic	Automatic	Automatic but can be overridden.	Automatic
Blower Preferred Automatic	Set blower knob to any desired airflow level other than Hi or Lo Auto. Set temperature knobs for Comfort.	User selectable to any speed.	Automatic	Automatic	Automatic but can be overridden.	Automatic
Mode Preferred and Manual Air Temperature Control	Set mode knob to any desired air delivery point. Adjust Temperature knobs to select the desired temperature.	Automatic. Although Auto Lo or Hi can be selected, a manually selected airflow level is recommend for the optimum comfort.	Manual	*Manual-automatic control of air temperature is disabled. User must adjust temperature knobs to obtain the desired temperature.	User selectable outside or recirculated.	User selectable A/C on or off.
Full Manual Operation	Set blower knob to any desired airflow level other than Hi or Lo Auto. Set mode knob to any desired air delivery point other than Auto. Adjust Temperature knobs to select the desired temperature.	Manual	Manual	*Manual-automatic control of air temperature is disabled. User must adjust temperature knobs to obtain the desired temperature.	User selectable outside or recirculated.	User selectable A/C on or off.

***Manual Air Temperature Control Operation:**

When the Mode knob is set to any position other than Auto, the Temperature knob operates in the non automatic comfort condition. The numbers on the Temperature dial are no longer valid in this mode. This mode allows the user to select any desired air temperature. When the temperature knob is in full counterclockwise position, the air temperature will be Cooler. As the knob is rotated clockwise, the temperature will increase gradually until the knob reaches the full clockwise position.

817dd45b

NOTE: Regardless of the type of operation, when a temperature knob is set to the full clockwise or full counterclockwise position, the system will deliver full hot or full cold air out of the ducts, respectively.

The operator can override the AUTO mode setting and select the direction of the air by rotating the right mode knob to one of the following positions. When the Mode is set to any position other than AUTO, The automatic control of air temperature is disabled. The user must adjust the temperature knobs to obtain the desired temperature.

- **Defrost**



Air is directed to the windshield through the outlets at the base of the windshield. Air is also directed to the front door windows through the side window demister grilles. Some airflow is delivered to the floor while in defrost so that comfort can be maintained.

NOTE: The defrost mode is not automatically selected. It must be manually selected, when desired.

- **Defrost/Floor**



Air flows through the front and rear floor outlets and the outlets at the base of the windshield. Air is also directed to the front door windows through the side window demister grilles. Some air-flow is delivered to the floor while in defrost so that comfort can be maintained.

- **Floor**



Air flows through the floor outlets located under the instrument panel and into the rear seating area through vents under the front seats. Some airflow is delivered to defrost while in floor mode, so that comfort can be maintained.

- **Bi-Level**



Air flows both through the outlets located in the instrument panel and those located on the floor.

Air flows through the registers in the back of the center console, and under the front seats to the rear seat passengers. These registers can be closed to block airflow. The center console outlets deliver conditioned air while the floor outlets deliver heated air.

- **Panel**



Air flows through the outlets located in the instrument panel. Air flows through the registers in the back of the center console to the rear seat passengers. These registers can be closed to block airflow.



Depress this button to turn on and off the air conditioning during manual operation only. Conditioned outside air is then directed through the outlets selected on the mode control dial. The button includes an LED that illuminates when manual operation is selected.

NOTE: To manually control the air conditioning the mode selector must be moved out of the AUTO position.



This button can be used to block out smoke, odors, dust, high humidity, or if rapid cooling is desired. The recirculation mode should only be used temporarily. The button includes an LED that illuminates, which indicates that the recirculation mode is active. You may use this feature separately.

NOTE: Extended use of recirculation may cause the windows to fog. If the interior of the windows begins to fog, press the “Recirculate” icon button to return to outside air. Some temp./humidity conditions will cause captured interior air to condense on windows and hamper visibility. For this reason, the system will not allow “Recirculate” to be selected while in the defrost or defrost/floor modes. Attempting to use the recirculation while in these modes will cause the LED in the button to blink and then turn off.

Rear Climate Control — If Equipped

The Manual Rear Climate Control system has one floor air outlet (passenger side), and two panel outlets in the rear quarter trim (on each side). The unit provides warm or cool air through the floor and upper outlets.

If rear heating/cooling is desired, press the “Rear On/Off Switch” (located in the upper switch bank above the controls) and select “Floor” “Bi-Level” or “Panel” from the Rear Control Panel (right knob located on the right rear quarter trim panel).

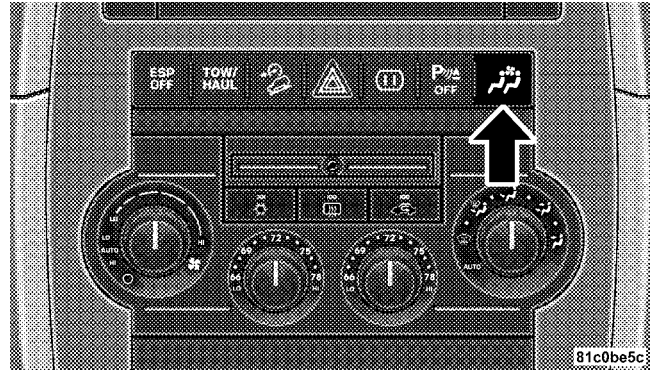

Rear On/Off Switch

The rear temperature, blower speed, and mode control can be adjusted as desired by the third row seat occupants.

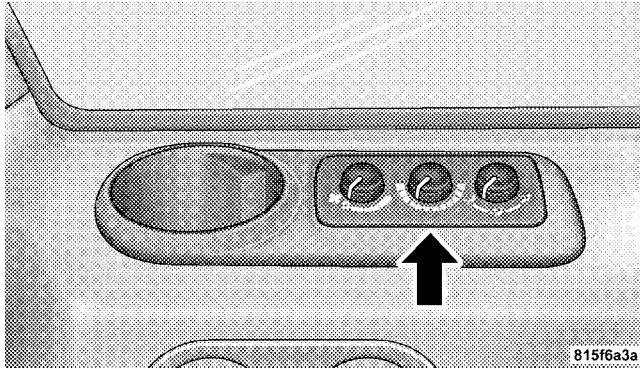

Rear Control Panel

NOTE: The rear climate control system cannot be controlled from the front seat; it can only be turned on and off. All control of the rear system must be performed by the rear occupants.

Rear Blower Control

The left knob on the Rear Control Panel has four positions, "Off", and a range of three blower speeds. This allows the third row seat occupants to control the volume of air circulated in the rear of the vehicle.

CAUTION!

Interior air enters the Manual Rear Zone Climate Control system through an intake grille located in the passenger side trim panel behind the third seat. The heater outlets are located in the passenger side trim panel just behind the sliding door. Do not block or place objects directly in front of the inlet grille or heater outlets. The electrical system could overload causing damage to the blower motor.

Rear Temperature Control

The center knob on the Rear Control Panel allows the third row seat occupants to have control of the rear temperature as follows:

- When the temperature knob is in the cold (Blue) position, cold air will be delivered from the outlets. As the temperature knob is turned towards the hot (Red) position, the air will get warmer.

Rear Mode Control

- **Floor**

 Air flows through the floor outlet located on the right side of the rear floor into the rear seating area.

- **Bi-Level**

 Air flows through both the outlets located in the rear quarter trim panels, and the one located on the floor. The rear quarter trim panel outlets can be closed to block airflow.

- **Panel**

 Air flows through the outlets located in the rear quarter trim panels. These registers can be closed to block airflow.

Operating Tips

Window Fogging

Windows will fog on the inside when the humidity inside the vehicle is high. This often occurs in mild or cool temperatures when it's rainy or humid. In most cases turning on the Air-conditioning (pressing the snowflake button) will clear the fog. Adjust the temperature control, air direction and blower speed to maintain comfort.

As the temperature gets colder it may be necessary to direct air onto the windshield. Adjust the temperature control and blower speed to maintain comfort. Higher blower speeds will reduce fogging. Interior fogging on the windshield can be quickly removed by selecting the defrost mode.

Regular cleaning of the inside of the windows with a non-filming cleaning solution (vinegar and water works very well) will help prevent contaminants (cigarette smoke, perfumes, etc.) from sticking to the windows. Contaminates increase the rate of window fogging.

Summer Operation

Air conditioned vehicles must be protected with a high quality antifreeze coolant during summer to provide proper corrosion protection and to raise the boiling point of the coolant for protection against overheating. A 50 % concentration is recommended. Refer to Recommended Fluids and Genuine Parts for the proper coolant type.

When using the air conditioner in extremely heavy traffic in hot weather especially when towing a trailer, additional engine cooling may be required. If this situation is encountered, operate the transmission in a lower gear to increase engine RPM, coolant flow and fan speed. When stopped in heavy traffic, it may be necessary to shift into

N (Neutral) and depress the accelerator slightly for fast idle operation to increase coolant flow and fan speed.

Your air conditioning system is also equipped with an automatic recirculation system. When the system senses a heavy load or high heat conditions, it may use partial Recirculation A/C mode to provide additional comfort.











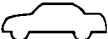





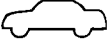

Winter Operation

When operating the system during the winter months, make sure the air intake, located directly in front of the windshield, is free of ice, slush, snow, or other obstructions.

Vacation Storage

Anytime you store your vehicle, or keep it out of service (i.e. vacation) for two weeks or more, run the air conditioning system at idle for about five minutes in the fresh air and high blower setting. This will insure adequate system lubrication to minimize the possibility of compressor damage when the system is started again.

Operating Tips Chart

WEATHER	CONTROL SETTINGS
<p>HOT WEATHER AND VEHICLE INTERIOR IS VERY HOT</p>  	<p>Open the windows, start the vehicle, set the Mode control to Panel  or Bi-Level , and turn on A/C. Set the Fan control to the High position (full clockwise). Set the temperature control to full cool. After the hot air is flushed from the vehicle, set the Mode control to Recirculate  with A/C on and roll up the windows. Once you are comfortable, set the Mode control to Panel  or Bi-Level  with A/C on.</p>
<p>WARM WEATHER</p>  	<p>If it's sunny, set the Mode control to Panel  and turn on A/C. If it's cloudy or dark, set the Mode control to Bi-Level  with A/C on. Adjust Temperature control for comfort.</p>
<p>COOL OR COLD HUMID CONDITIONS</p>  	<p>Set the Mode control to Defrost/Floor  or Defrost . Set the Fan Control to the High position (full clockwise). Adjust Fan and Temperature control for comfort if windows are clear.</p>
<p>COLD DRY CONDITIONS</p>  	<p>Set the Mode control to Floor . If it's sunny, you may want more upper air. In this case, set the Mode control to Bi-Level . In very cold weather, if you need extra heat at the windshield, set the Mode control to Defrost/Floor  or Defrost  as needed. Adjust Fan and Temperature control for comfort.</p>

81352266

STARTING AND OPERATING

CONTENTS

■ Starting Procedures	277	□ Brake/Transmission Interlock System	283
□ Normal Starting	278	□ 5-Speed Automatic Transmission	283
□ Extremely Cold Weather (Below -20°F Or -29°C)	278	□ Gear Ranges	283
□ If Engine Fails To Start	279	□ Rocking The Vehicle	289
□ After Starting	280	■ Four-Wheel Drive Operation	290
■ Engine Block Heater — If Equipped	280	□ Quadra-Trac I® Operating Instructions/ Precautions — If Equipped	290
■ Automatic Transmission	281	□ Quadra-Trac II® Operating Instructions/Precautions — If Equipped	291
□ Shift Lock Manual Override — If Equipped	281	□ Shift Positions	292

274 STARTING AND OPERATING

- Shifting Procedures293
- Quadra-Drive II® System — If Equipped295
- On-Road Driving Tips296
- Off-Road Driving Tips296
 - When To Use 4WD Low Range —
If Equipped296
 - Driving Through Water296
 - Driving In Snow, Mud And Sand298
 - Hill Climbing298
 - Traction Downhill299
 - After Driving Off-Road299
- Parking Brake300
- Anti-Lock Brake System302
- Power Steering305
- Multi Displacement System (MDS) — 5.7L Engine
Only306
- Tire Safety Information306
 - Tire Markings306
 - Tire Identification Number (TIN)310
 - Tire Loading And Tire Pressure311
- Tires — General Information315
 - Tire Pressure315
 - Tire Inflation Pressures316
 - Tire Pressures For High Speed Operation318
 - Radial-Ply Tires318
 - Tire Spinning318

- Tread Wear Indicators 319
- Life Of Tire 320
- Replacement Tires 320
- Alignment And Balance 321
- Tire Chains 322
- Tire Rotation Recommendations 322
- Tire Pressure Monitor System (TPMS) 323
 - Base System — If Equipped 326
 - Premium System — If Equipped 328
 - General Information 333
- Fuel Requirements 333
 - 3.7/4.7L Engines (If Equipped) 333
 - 5.7L Engines (If Equipped) 333
 - Reformulated Gasoline 334
 - Gasoline/Oxygenate Blends 335
 - MMT In Gasoline 335
 - Materials Added To Fuel 336
 - Fuel System Cautions 336
 - Carbon Monoxide Warnings 337
- Flexible Fuel (4.7L Engine Only) — If Equipped 337
 - E-85 General Information 337
 - Ethanol Fuel (E-85) 338
 - Fuel Requirements 339
 - Selection Of Engine Oil For Flexible Fuel Vehicles (E-85) And Gasoline Vehicles 340
 - Starting 340

276 STARTING AND OPERATING

- Cruising Range340
- Replacement Parts340
- Adding Fuel341
 - Fuel Filler Cap (Gas Cap)341
- Vehicle Loading344
 - Certification Label344
- Trailer Towing346
 - Common Towing Definitions346
 - Trailer Hitch Classification350
 - Trailer Towing Weights (Maximum Trailer Weight Ratings)350
 - Trailer And Tongue Weight352
 - Towing Requirements353
 - Towing Tips357
- Recreational Towing (Behind Motorhome, Etc.) . . .359
 - Towing – 2WD Models359
 - Towing — Quadra-Trac I (Single-Speed Transfer Case) 4WD Models359
 - Towing — Quadra-Trac II /Quadra-Drive II 4WD Models359
- Snow Plow363

STARTING PROCEDURES

Before starting your vehicle, adjust your seat, adjust the inside and outside mirrors, fasten your seat belt, and if present, instruct all other occupants to buckle their seat belts.

WARNING!

- **Never leave children alone in a vehicle. Leaving children in a vehicle unattended is dangerous for a number of reasons. A child or others could be seriously or fatally injured. Don't leave the keys in the ignition. A child could operate power windows, other controls, or move the vehicle.**
- **Do not leave animals or children inside parked vehicles in hot weather; interior heat build up may cause serious injury or death.**
- **Be sure to turn off the engine and remove the key from the ignition switch if you want to rest or sleep in your car. Accidents can be caused by inadvertently moving the gear selection lever. Accidents can also be caused by pressing the accelerator pedal. This may cause excessive heat in the exhaust system, resulting in overheating and vehicle fire, which may cause serious or fatal injuries.**

Normal Starting

The gear selector must be in the “N” (Neutral) or “P” (Park) position before you can start the engine. Apply the brakes before shifting into any driving gear.

NOTE: Normal starting of either a cold or a warm engine is obtained without pumping or depressing the accelerator pedal.

Do not press the accelerator. Use the Fob with Integrated Key to briefly turn the ignition switch to the START position and release it as soon as the starter engages. The starter motor will continue to run, and it will disengage automatically when the engine is running. If the engine fails to start, the starter will disengage automatically in 10 seconds. If this occurs, turn the ignition switch to the LOCK position, wait 10 to 15 seconds, then repeat the normal starting procedure.

Extremely Cold Weather (below –20°F or –29°C)

To insure reliable starting at these temperatures, use of an externally powered electric engine block heater (available from your dealer) is recommended.

If Engine Fails to Start

WARNING!

- **Never pour fuel or other flammable liquids into the throttle body air inlet opening in an attempt to start the vehicle. This could result in a flash fire causing serious personal injury.**
- **Do not attempt to push or tow your vehicle to get it started. Vehicles equipped with an automatic transmission cannot be started this way. Unburned fuel could enter the catalytic converter and once the engine has started, ignite and damage the converter and vehicle. If the vehicle has a discharged battery, booster cables may be used to obtain a start from a booster battery or the battery in another vehicle. This type of start can be dangerous if done improperly. Refer to Section 6 of this manual for proper jump starting procedures and follow them carefully.**

If the engine fails to start after you have followed the “Normal Starting” or “Extreme Cold Weather” procedures, it may be flooded. To clear any excess fuel, push the accelerator pedal all the way to the floor and hold it. Then, turn the ignition switch to the START position and release it as soon as the starter engages. The starter motor will disengage automatically in 10 seconds. Once this occurs, release the accelerator pedal, turn the ignition switch to the LOCK position, wait 10 to 15 seconds, then repeat the normal starting procedure.

CAUTION!

To prevent damage to the starter, wait 10 to 15 seconds before trying again.

After Starting

The idle speed is controlled automatically and it will decrease as the engine warms up.

ENGINE BLOCK HEATER — IF EQUIPPED

The engine block heater warms engine coolant and permits quicker starts in cold weather. Connect the heater cord to a ground-fault interrupter protected 110-115 volt AC electrical outlet with a grounded, three-wire extension cord.

Use the heater when temperatures below 0°F (-18°C) are expected to last for several days.

The block heater must be plugged in at least one hour to have an adequate warming effect on the coolant.

The engine block heater cord is located:

- 3.7L/4.7L Engine — coiled and strapped to the engine oil dipstick tube.
- 5.7L Engine — bundled and fastened to the injector harness.

WARNING!

Remember to disconnect the cord before driving. Damage to the 110-115 volt AC electrical cord could cause electrocution.

AUTOMATIC TRANSMISSION

CAUTION!

Damage to the transmission may occur if the following precautions are not observed:

- Shift into P (Park) only after the vehicle has come to a complete stop.
- Shift into or out of R (Reverse) only after the vehicle has come to a complete stop and the engine is at idle speed.
- Do not shift from R (Reverse), P (Park), or N (Neutral) into any forward gear when the engine is above idle speed.
- Before shifting into any gear, make sure your foot is firmly on the brake pedal.

WARNING!

It is dangerous to shift the selector lever out of P (Park) or N (Neutral) if the engine speed is higher than idle speed. If your foot is not firmly on the brake pedal, the vehicle could accelerate quickly forward or in reverse. You could lose control of the vehicle and hit someone or something. Only shift into gear when the engine is idling normally and when your foot is firmly on the brake pedal.

5

Shift Lock Manual Override — If Equipped

Your vehicle may be equipped with a shift lock manual override. The manual override may be used in the event that the shift lever should fail to move from Park with the key in the ON position and the brake pedal depressed. To operate the shift lock manual override, perform the following steps:

1. Firmly set the parking brake.
2. Using a flat blade screwdriver, carefully remove the shift lock manual override cover which is located on the PRNDL bezel.
3. Depress and maintain firm pressure on the brake pedal.
4. Using the screwdriver, reach into the manual override opening. Press and hold the shift lock lever down.

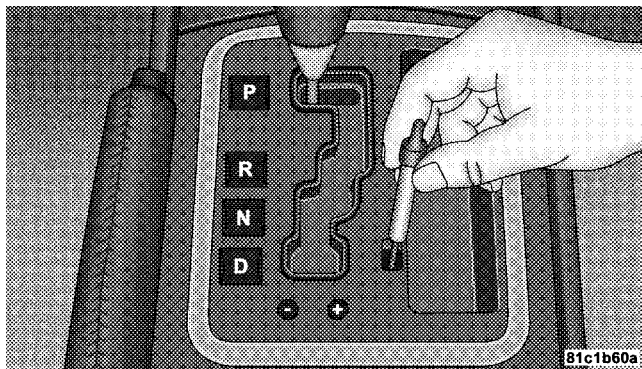

5. Move the shift lever into the N (Neutral) position.
6. The vehicle may then be started in N (Neutral).

Have your vehicle inspected by your local authorized dealer, if the shift lock manual override has been used.

Brake/Transmission Interlock System

This system prevents you from moving the gear shift out of P (Park) and into any gear unless the brake pedal is pressed. This system is active only while the ignition switch is in the ON position. Always depress the **brake pedal first**, before moving the gear selector out of P (Park).

5-Speed Automatic Transmission

The electronically controlled transmission provides a precise shift schedule. The transmission electronics are self-calibrating; therefore, the first few shifts on a new vehicle, may be somewhat abrupt. This is a normal condition, and precision shifts will develop within a few hundred miles.

Gear Ranges

NOTE: After selecting any gear range, wait a moment to allow the selected gear to engage before accelerating. This is especially important when the engine is cold. If there is a need to restart the engine be sure to cycle the key to the LOCK position before restarting. Transmission gear engagement may be delayed after restarting the engine if the key is not cycled to the LOCK position first.

P (Park)

This gear position supplements the parking brake by locking the transmission. The engine can be started in this range. Never use P (Park) while the vehicle is in motion. Apply the parking brake when leaving the vehicle in this range. Always apply parking brake first, then place the selector in P (Park) position.

WARNING!

Never use P (Park) position as a substitute for the parking brake. Always apply parking brake fully when parked to guard against vehicle movement and possible injury or damage.

WARNING!

It is dangerous to shift the selector lever out of P (Park) or N (Neutral) if the engine speed is higher than idle speed. If your foot is not firmly on the brake pedal, the vehicle could accelerate quickly forward or in reverse. You could lose control of the vehicle and hit someone or something. Only shift into gear when the engine is idling normally and when your right foot is firmly on the brake pedal.

R (Reverse)

Use this range only after the vehicle has come to a complete stop.

N (Neutral)

Shift into N (Neutral) when the vehicle is standing for prolonged periods with the engine running. The engine may be started in this range. Set the parking brake if you must leave the vehicle.

NOTE: Towing the vehicle, coasting, or driving for any other reason with selector lever in N (Neutral) can result in severe transmission damage. Refer to “Recreational Towing” in Section 5 and “Towing a Disabled Vehicle” in Section 6 of this manual.

D (Drive)

Shift into D (Drive) only when the vehicle is at a complete stop and the brakes are firmly applied. The transmission automatically upshifts through fifth gear. The D (Drive) position provides optimum driving characteristics under all normal operating conditions.

Electronic Range Select (ERS) Operation

The Electronic Range Select (ERS) shift control allows you to move the shifter left (-) or right (+) when the shifter is in the D (Drive) position, allowing the selection of the desired top gear. For example, if the driver shifts the transmission into 3 (third gear), the transmission will never shift above third gear, but can shift down to 2 (second) or 1 (first), when needed.

When in the D (Drive) position, the first tap to the left (-), will show the current gear. For example, if you are in D (Drive) and are in 3rd gear, when you tap the gear shift one time to the left (-), the display will show 3. Another tap to the left (-) will shift the transmission into 2nd gear. If you are in D (Drive) and are in 5th gear, the first tap to the left (-) will display 5. Another tap to the left (-) will shift the transmission into 4th gear.

On vehicles equipped with 4.7L or 5.7L engines, use of ERS (or Tow/Haul mode) also enables a additional underdrive gear which is not normally used during

through-gear accelerations. This additional gear improves vehicle performance and cooling capability when towing a trailer on certain grades. In ERS mode (on all transmissions), 1st through 3rd gear are underdrive gears and 4th gear is direct drive. ERS 5th gear (Overdrive) is the same as the normal 4th gear.

WARNING!

Do not downshift for additional engine braking on a slippery surface. The drive wheels could lose their grip and the vehicle could skid.

Screen Display	1	2	3	4	5*	D
Actual Gear(s) Allowed	1	1-2	1-3	1-4	1-5	1-5

*** Applies to vehicles equipped with 4.7L/5.7L engines only.**

NOTE: To select the proper gear position for maximum deceleration (engine braking), move the shift lever to the left “D(-)” and hold it there. The transmission will shift to the range from which the vehicle can best be slowed down.

Overdrive Operation

The automatic transmission includes an electronically controlled Overdrive (5th gear for 3.7L engine, 4th and 5th gears for 4.7L and 5.7L engines). The transmission will automatically shift from direct gear to Overdrive if the following conditions are present:

- the transmission selector is in D (Drive);
- the engine coolant has reached normal operating temperature;
- vehicle speed is above approximately 30 mph (48 km/h);
- the “TOW/HAUL” switch has not been activated;

- transmission has reached normal operating temperature.

NOTE: If the vehicle is started in extremely cold temperatures, the transmission may not shift into Overdrive and will automatically select the most desirable gear for operation at this temperature. Normal operation will resume when the transmission fluid temperature has risen to a suitable level. Refer also to the Note under torque converter clutch, later in this section.

During cold temperature operation you may notice delayed upshifts depending on engine and transmission temperature. This feature improves the warm up time of the engine and transmission.

If the transmission temperature gets extremely hot, the transmission will automatically select the most desirable gear for operation at this temperature. If the transmission temperature becomes hot enough, the “TRANSMISSION

OVER TEMP” message may display and the transmission may downshift out of Overdrive until the transmission cools down. After cool down, the transmission will resume normal operation.

In high ambient temperatures with sustained high engine speed and load, an upshift followed shortly thereafter by a downshift may occur. This is a normal part of the overheat protection strategy when operating in the “Tow/Haul” mode.

The transmission will downshift from Overdrive to the most desirable gear if the accelerator pedal is fully depressed at vehicle speeds above approximately 35 mph (56 km/h).

When To Use “TOW/HAUL” Mode — If Equipped

When driving in hilly areas, towing a trailer, carrying a heavy load, etc., and frequent transmission shifting occurs, press the “TOW/HAUL” switch. This will improve performance and reduce the potential for transmission

overheating or failure due to excessive shifting. When operating in “TOW/HAUL” mode, the transmission will shift to direct gear and Overdrive will be enabled under steady cruise conditions.

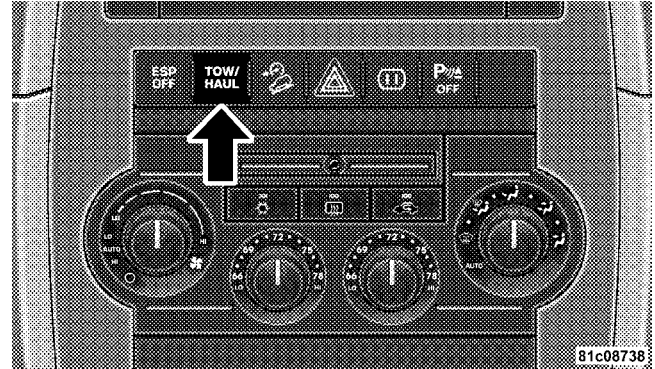

TOW/HAUL Switch

The “TOW/HAUL” light will illuminate in the instrument cluster to indicate when the switch has been

activated. Pressing the switch a second time restores normal operation. If the “TOW/HAUL” mode is desired, the switch must be pressed each time the engine is started.

Transmission Limp Home Mode

Transmission function is monitored for abnormal conditions. If a condition is detected that could result in transmission damage, the transmission limp home mode will be engaged. In this mode, the transmission will remain in the current gear (3.7L engine) or in direct gear (4.7L and 5.7L engines) until the vehicle is brought to a stop.

To reset the transmission, use the following procedure:

1. Stop the vehicle.
2. Move the shift lever to the P (Park) position.
3. Turn off the engine, be sure to turn the key to the LOCK position.

4. Wait approximately 10 seconds, then restart the engine.

5. Move the shift lever to the desired gear range.

If the problem is no longer detected, the transmission will return to normal operation. If the problem persists, P (Park), R (Reverse), and N (Neutral) will continue to operate. Only 2nd gear (3.7L engine) or 3rd gear (4.7L and 5.7L engines) will be available in the D (Drive) position. Have the transmission checked at your authorized dealer as soon as possible.

Torque Converter Clutch

A feature, designed to improve fuel economy, has been included in the automatic transmission on your vehicle. A clutch within the torque converter engages automatically at a calibrated speed at light throttle. It engages at higher speeds under heavier acceleration. This may result in a slightly different feeling or response during normal operation in high gear. When the vehicle speed

drops below a calibrated speed, or during acceleration, the clutch automatically and smoothly disengages. The feature is operational in Overdrive and in Drive.

NOTE: The torque converter clutch will not engage until the transmission fluid and engine coolant are warm [usually after 1-3 miles (1.6 - 4.8 km) of driving]. Because the engine speed is higher when the torque converter clutch is not engaged, it may seem as if the transmission is not shifting into Overdrive when cold. This is normal. Manually shifting (using the ERS shift control) between 4 (direct gear) and 5/D (Overdrive gear) positions will demonstrate that the transmission is able to shift into and out of Overdrive.

NOTE: If the vehicle has not been driven in several days, the first few seconds of operation after shifting the transmission into gear may seem sluggish. This is due to the fluid partially draining from the torque converter into the transmission. This condition is normal and will not

cause damage to the transmission. The torque converter will refill within five seconds of shifting from Park into any other gear position.

Rocking the Vehicle

If the vehicle becomes stuck in snow, sand, or mud, it can often be moved by a rocking motion. Move the gear selector rhythmically between D (Drive) and R (Reverse), while applying slight pressure to the accelerator.

NOTE: The Electronic Stability Program (ESP) and Traction Control (if equipped) should be turned OFF before attempting to rock the vehicle. Refer to “Electronic Brake Control System” in Section 3 of this manual.

The least amount of accelerator pedal pressure to maintain the rocking motion without spinning the wheels or racing the engine is most effective. Racing the engine or spinning the wheels, due to the frustration of not freeing the vehicle, may lead to transmission overheating and failure. Allow the engine to idle with the transmission

selector in N (Neutral) for at least one minute after every five rocking-motion cycles. This will minimize overheating and reduce the risk of transmission failure during prolonged efforts to free a stuck vehicle.

CAUTION!

When “rocking” a stuck vehicle by moving between “First” and R (Reverse), do not spin the wheels faster than 15 mph (24 km/h), or drivetrain damage may result.

FOUR-WHEEL DRIVE OPERATION

Quadra-Trac I® Operating Instructions/Precautions — If Equipped

The Quadra-Trac I® is a single speed (HI range only) transfer case which provides convenient full-time 4-wheel drive. No driver interaction is required. This transfer case divides engine torque almost evenly with 48 percent of engine torque to the front axle and 52 percent of engine torque to the rear axle. The Brake Traction Control System (BTC), which combines standard ABS and Traction Control, provides resistance to any wheel that is slipping to allow additional torque transfer to wheels with traction.

NOTE: The Quadra-Trac I® system is not appropriate for conditions where LOW range is recommended. Refer to “Off-Road Driving Tips” in this section.

Quadra-Trac II® Operating Instructions/Precautions — If Equipped

The Quadra-Trac II® transfer case is fully automatic in the normal driving 4 HI mode. The Quadra-Trac II® transfer case provides three mode positions — four wheel drive high range, neutral, and four wheel drive low range.

This transfer case is fully automatic in the 4 HI mode. This transfer case divides engine torque almost evenly with 48 percent of engine torque to the front axle and 52 percent of engine torque to the rear axle. When speed differences are increased between the front and rear drive shafts, the transfer case can transmit up to 100 percent of available engine torque to the front or rear drive shafts.

When additional traction is required, the 4 LOW position can be used to lock the front and rear driveshafts together and force the front and rear wheels to rotate at the same speed. The 4 LOW position is intended for loose, slippery

road surfaces only. Driving in the 4 LOW position on dry hard surfaced roads may cause increased tire wear and damage to driveline components.

When operating your vehicle in 4 LOW, the engine speed is approximately three times that of the 4 HI position at a given road speed. Take care not to overspeed the engine and do not exceed 25 mph (40 km/h).

Proper operation of four wheel drive vehicles depends on tires of equal size, type, and circumference on each wheel. Any difference will adversely affect shifting and cause damage to the transfer case.

Because four wheel drive provides improved traction, there is a tendency to exceed safe turning and stopping speeds. Do not go faster than road conditions permit.

WARNING!

You or others could be injured if you leave the vehicle unattended with the transfer case in the N (Neutral) position without first fully engaging the parking brake. The transfer case N (Neutral) position disengages both the front and rear driveshafts from the powertrain and will allow the vehicle to move regardless of the transmission position. The parking brake should always be applied when the driver is not in the vehicle.

Shift Positions

For additional information on the appropriate use of each transfer case mode position, see the information below:

4 HI

Four Wheel Drive High Range — All roads surfaces such as ice, snow, gravel, sand, and dry hard pavement.

N (Neutral)

Neutral — Disengages both the front and rear driveshafts from the powertrain. To be used for flat towing behind another vehicle. Refer to “Recreational Towing” in Section 5 of this manual.

4 LOW

Four Wheel Drive Low Range — Low speed 4 wheel drive. Locks the front and rear driveshafts together. Forces the front and rear wheels to rotate at the same speed. Additional traction and maximum pulling power for loose, slippery road surfaces only. Do not exceed 25 mph (40 km/h).

Shifting Procedures

4 HI to 4 LOW

With the vehicle at speeds of 0 to 3 mph (0 to 5 km/h), key ON or engine running, shift the transmission into N (Neutral), and raise the transfer case T-handle. “The 4WD LOW Indicator Lamp” in the instrument cluster will begin to flash and remain on solid when the shift is complete. Release the T-handle.

NOTE: If shift conditions/interlocks are not met, or a transfer case motor temperature protection condition exists, a “CHECK SHIFT PROCEDURES” message will flash from the EVIC (Electronic Vehicle Information Center). Refer to “Electronic Vehicle Information Center (EVIC)” in Section 4 of this manual.

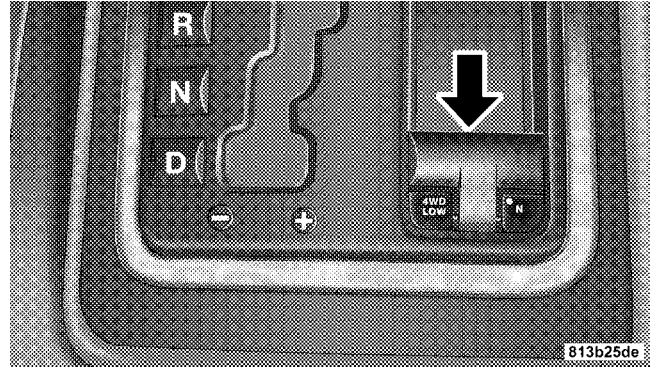

Shifter T-Handle

4 LOW to 4 HI

With the vehicle at speeds of 0 to 3 mph (0 to 5 km/h), key ON or engine running, shift the transmission into N (Neutral), and raise the transfer case T-handle. The “4WD

LOW Indicator Lamp” in the instrument cluster will flash and go out when the shift is complete. Release the T-handle.

NOTE: If shift conditions/interlocks are not met, or a transfer case motor temperature protection condition exists, a “CHECK SHIFT PROCEDURES” message will flash from the EVIC (Electronic Vehicle Information Center). Refer to “Electronic Vehicle Information Center (EVIC)” in Section 4 of this manual.

NOTE: Shifting into or out of 4WD LOW is possible with the vehicle completely stopped, however difficulty may occur due to the mating clutch teeth not being properly aligned. Several attempts may be required for clutch teeth alignment and shift completion to occur. The preferred method is with the vehicle rolling 0 to 3 mph (0 to 5 km/h). If the vehicle is moving faster than 3 mph (5 km/h), the transfer case will not allow the shift.

Neutral (N) Shift Procedure

1. Key ON, engine off.
2. Vehicle stopped, with foot on brake.
3. Place transmission in N (Neutral).
4. Hold down N (Neutral) “pin” switch (with a pen, etc.) for 4 seconds until the LED lamp by the switch starts to blink indicating shift in progress. Lamp will stop blinking (stay on solid) when Neutral shift is complete. A “4WD SYSTEM IN NEUTRAL” message will display on the EVIC (Electronic Vehicle Information Center). Refer to “Electronic Vehicle Information Center (EVIC)” in Section 4 of this manual.

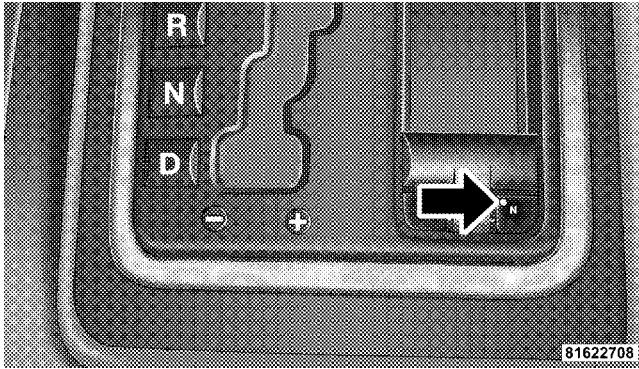

Neutral Switch

- Repeat Steps 1– 4 to shift out of Neutral.

NOTE: If shift conditions/interlocks are not met, a “CHECK SHIFT PROCEDURES” message will flash from the EVIC (Electronic Vehicle Information Center). Refer to “Electronic Vehicle Information Center (EVIC)” in Section 4 of this manual.

Quadra-Drive II® System — If Equipped

The optional Quadra-Drive II® System features three torque transfer couplings. The couplings include ELSD (Electronic Limited Slip Differential) front and rear axles and Quadra-Trac II® transfer case. The optional ELSD axles are fully automatic and require no driver input to operate. Under normal driving conditions the units function as standard axles balancing torque evenly between left and right wheels. With a traction difference between left and right wheels the coupling will sense a speed difference. As one wheel begins to spin faster than the other, torque will automatically transfer from the wheel that has less traction to the wheel that has traction. While the transfer case and axle couplings differ in design, their operation is similar. Follow the Quadra-Trac II® transfer case shifting information, preceding this section, for shifting this system.

ON-ROAD DRIVING TIPS

Utility vehicles have higher ground clearance and a narrower track to make them capable of performing in a wide variety of off-road applications. Specific design characteristics give them a higher center of gravity than ordinary cars.

An advantage of the higher ground clearance is a better view of the road, allowing you to anticipate problems. They are not designed for cornering at the same speeds as conventional 2-wheel drive vehicles any more than low-slung sports cars are designed to perform satisfactorily in off-road conditions. If at all possible, avoid sharp turns or abrupt maneuvers. As with other vehicles of this type, failure to operate this vehicle correctly may result in loss of control or vehicle rollover.

OFF-ROAD DRIVING TIPS

NOTE: Prior to off-road driving, remove the front air dam to prevent damage. The front air dam is attached to the lower front fascia with quarter turn fasteners, and can be removed by hand.

When To Use 4WD LOW Range — If Equipped

When off-road driving, shift to 4WD LOW for additional traction. This range should be limited to extreme situations such as deep snow, mud, or sand where additional low speed pulling power is needed. Vehicle speeds in excess of 25 mph (40 km/h) should be avoided when in 4WD LOW range.

Driving Through Water

Although your vehicle is capable of driving through water, there are a number of precautions that must be considered before entering the water:

CAUTION!

When driving through water, do not exceed 5 mph (8 km/h). Always check water depth before entering as a precaution, and check all fluids afterward. Driving through water may cause damage that may not be covered by the new vehicle limited warranty.

Driving through water more than a few inches deep will require extra caution to ensure safety and prevent damage to your vehicle. If you must drive through water, try to determine the depth and the bottom condition (and location of any obstacles) prior to entering. Proceed with caution and maintain a steady controlled speed less than 5 mph (8 km/h) in deep water to minimize wave effects.

Flowing Water

If the water is swift flowing and rising (as in storm run-off) avoid crossing until the water level recedes

and/or the flow rate is reduced. If you must cross flowing water avoid depths in excess of 9 inches. The flowing water can erode the streambed causing your vehicle to sink into deeper water. Determine exit point(s) that are downstream of your entry point to allow for drifting.

Standing Water

Avoid driving in standing water deeper than 20 inches, and reduce speed appropriately to minimize wave effects. Maximum speed in 20 inches of water is less than 5 mph (8 km/h).

Maintenance

After driving through deep water, inspect your vehicle fluids and lubricants (engine oil, transmission oil, axle, transfer case) to assure the fluids have not been contaminated. Contaminated fluid (milky, foamy in appearance) should be flushed/changed as soon as possible to prevent component damage.

Driving In Snow, Mud and Sand

In heavy snow, when pulling a load, or for additional control at slower speeds, shift the transmission to a low gear and shift the transfer case to 4WD LOW if necessary. Refer to “Four-Wheel Drive Operation” in this section. Do not shift to a lower gear than necessary to maintain forward motion. Over-revving the engine can spin the wheels and traction will be lost.

Avoid abrupt downshifts on icy or slippery roads, because engine braking may cause skidding and loss of control.

Hill Climbing

NOTE: Before attempting to climb a hill, determine the conditions at the crest and/or on the other side.

Before climbing a steep hill, shift the transmission to a lower gear and shift the transfer case to 4WD LOW. Use first gear and 4WD LOW for very steep hills.

If you stall or begin to lose forward motion while climbing a steep hill, allow your vehicle to come to a stop and immediately apply the brakes. Restart the engine and shift to R (Reverse). Back slowly down the hill allowing the compression braking of the engine to help regulate your speed. If the brakes are required to control vehicle speed, apply them lightly and avoid locking or skidding the tires.

WARNING!

If the engine stalls, you lose forward motion, or cannot make it to the top of a steep hill or grade, never attempt to turn around. To do so may result in tipping and rolling the vehicle. Always back carefully straight down a hill in R (Reverse) gear. Never back down a hill in N (Neutral) using only the brake.

Remember, never drive diagonally across a hill—always drive straight up or down.

If the wheels start to slip as you approach the crest of a hill, ease off the accelerator and maintain forward motion by turning the front wheels slowly. This may provide a fresh “bite” into the surface and will usually provide traction to complete the climb.

Traction Downhill

Shift the transmission into a low gear and the transfer case to 4WD LOW range. Let the vehicle go slowly down the hill with all four wheels turning against engine compression drag. This will permit you to control the vehicle speed and direction.

When descending mountains or hills, repeated braking can cause brake fade with loss of braking control. Avoid repeated heavy braking by downshifting the transmission whenever possible.

After Driving Off-Road

Off-road operation puts more stress on your vehicle than does most on-road driving. After going off-road it is always a good idea to check for damage. That way you can get any problems taken care of right away and have your vehicle ready when you need it.

- Completely inspect the underbody of your vehicle. Check tires, body structure, steering, suspension, and exhaust system for damage.
- Check threaded fasteners for looseness, particularly on the chassis, drivetrain components, steering, and suspension. Retighten them, if required, and torque to the values specified in the Service Manual.
- Check for accumulations of plants or brush. These things could be a fire hazard. They might hide damage to fuel lines, brake hoses, axle pinion seals, and propeller shafts.

- After extended operation in mud, sand, water, or similar dirty conditions, have brake rotors, wheels, brake linings, and axle yokes inspected and cleaned as soon as possible.

WARNING!

Abrasive material in any part of the brakes may cause excessive wear or unpredictable braking. You might not have full braking power when you need it to prevent an accident. If you have been operating your vehicle in dirty conditions, get your brakes checked and cleaned as necessary.

- If you experience unusual vibration after driving in mud, slush or similar conditions, check the wheels for impacted material. Impacted material can cause a wheel imbalance and freeing the wheels of it will correct the situation.

PARKING BRAKE

To set the parking brake, pull the lever up as firmly as possible. When the parking brake is applied with the ignition ON, the “Brake Warning Light” in the instrument cluster will light. To release the parking brake, pull up slightly, press the center button, then lower the lever completely.

NOTE: The instrument cluster “Brake Warning Light” indicates only that the parking brake is applied. It does not indicate the degree of brake application.

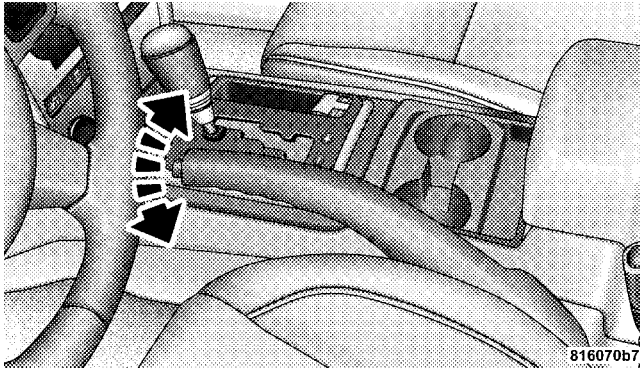

Parking Brake

Be sure the parking brake is firmly set when parked and the gear shift lever is in the P (Park) position. When parking on a hill, you should apply the parking brake before placing the gear shift lever in P (Park), otherwise the load on the transmission locking mechanism may make it difficult to move the selector out of P (Park).

WARNING!

- Always fully apply the parking brake when leaving your vehicle, or it may roll and cause damage or injury. Also, be certain to leave the transmission in P (Park). Failure to do so may allow the vehicle to roll and cause damage or injury.
- Leaving children in a vehicle unattended is dangerous for a number of reasons. A child or others could be injured. Children should be warned not to touch the parking brake or the gear selector lever. Don't leave the keys in the ignition. A child could operate power windows, other controls, or move the vehicle.
- Be sure the parking brake is fully disengaged before driving, failure to do so can lead to brake problems due to excessive heating of the rear brakes.

When parking on a hill, turn the front wheels toward the curb on a downhill grade and away from the curb on an uphill grade.

The parking brake should always be applied whenever the driver is not in the vehicle.

ANTI-LOCK BRAKE SYSTEM

The Anti-Lock Brake System (ABS) is designed to aid the driver in maintaining vehicle control under adverse braking conditions. The system operates with a separate computer to modulate hydraulic pressure to prevent wheel lock-up and help avoid skidding on slippery surfaces.

All vehicle wheels and tires must be the same size and type and tires must be properly inflated to produce accurate signals for the computer.

WARNING!

Significant over or under inflation of tires or mixing sizes of tires or wheels on the vehicle can lead to loss of braking effectiveness.

The Anti-Lock Brake System conducts a low-speed self-test at about 12 mph (20 km/h). If you have your foot lightly on the brake while this test is occurring, you may feel slight pedal movement. The movement can be more apparent on ice and snow. This is normal.

The Anti-Lock Brake System pump motor runs during the self-test at 12 mph (20 km/h) and during an ABS stop. The pump motor makes a low humming noise during operation, which is normal.

WARNING!

Pumping of the Anti-Lock Brakes will diminish their effectiveness and may lead to an accident. Pumping makes the stopping distance longer. Just press firmly on your brake pedal when you need to slow down or stop.

WARNING!

- **The Anti-Lock Brake System (ABS) cannot prevent the natural laws of physics from acting on the vehicle, nor can it increase braking or steering efficiency beyond that afforded by the condition of the vehicle brakes and tires or the traction afforded.**
- **The ABS cannot prevent accidents, including those resulting from excessive speed in turns, following another vehicle too closely, or hydroplaning. Only a safe, attentive, and skillful driver can prevent accidents.**
- **The capabilities of an ABS equipped vehicle must never be exploited in a reckless or dangerous manner, which could jeopardize the user's safety or the safety of others.**

CAUTION!

The Anti-Lock Brake System is subject to possible detrimental effects of electronic interference caused by improperly installed after-market radios or telephones.

NOTE: During severe braking conditions, a pulsing sensation may occur and a clicking noise will be heard. This is normal, indicating that the Anti-Lock Brake System is functioning.

WARNING!

To use your brakes and accelerator more safely, follow these tips:

- Do not “ride” the brakes by resting your foot on the pedal. This could overheat the brakes and result in unpredictable braking action, longer stopping distances, or brake damage.
- When descending mountains or hills, repeated braking can cause brake fade with loss of braking control. Avoid repeated heavy braking by downshifting the transmission or locking out overdrive whenever possible.
- Engines may idle at higher speeds during warm-up, which could cause rear wheels to spin and result in loss of vehicle control. Be especially careful while driving on slippery roads, in close quarter maneuvering, parking, or stopping.
- Do not drive too fast for road conditions, especially when roads are wet or slushy. A wedge of water can

build up between the tire tread and the road. This hydroplaning action can cause loss of traction, braking ability, and control.

- After going through deep water or a car wash, brakes may become wet, resulting in decreased performance and unpredictable braking action. Dry the brakes by gentle, intermittent pedal action while driving at very slow speeds.

POWER STEERING

The standard power steering system will give you good vehicle response and increased ease of maneuverability in tight spaces. The system will provide mechanical steering capability if power assist is lost.

If for some reason the power assist is interrupted, it will still be possible to steer your vehicle. Under these conditions, you will observe a substantial increase in steering effort, especially at very low vehicle speeds and during parking maneuvers.

NOTE: Increased noise levels at the end of the steering wheel travel are considered normal and do not indicate that there is a problem with the power steering system.

Upon initial start-up in cold weather, the power steering pump may make noise for a short amount of time. This is due to the cold, thick fluid in the steering system. This noise should be considered normal, and it does not in any way damage the steering system.

WARNING!

Continued operation with reduced power steering assist could pose a safety risk to yourself and others. Service should be obtained as soon as possible.

CAUTION!

Prolonged operation of the steering system at the end of the steering wheel travel will increase the steering fluid temperature and it should be avoided when possible. Damage to the power steering pump may occur.

MULTI DISPLACEMENT SYSTEM (MDS) — 5.7L Engine Only

This feature offers improved fuel economy by shutting off four of the engine's eight cylinders during light load and cruise conditions. The system is automatic with no driver inputs or additional driving skills required.

NOTE: The MDS system may take some time to return to full functionality after a battery disconnect.

TIRE SAFETY INFORMATION

Tire Markings

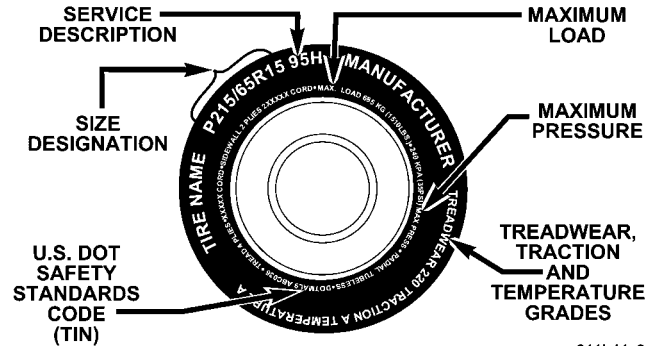

811b44e8

NOTE:

- P (Passenger)-Metric tire sizing is based on U.S. design standards. P-Metric tires have the letter "P" molded into the sidewall preceding the size designation. Example: P215/65R15 95H.

- European Metric tire sizing is based on European design standards. Tires designed to this standard have the tire size molded into the sidewall beginning with the section width. The letter "P" is absent from this tire size designation. Example: 215/65R15 96H
- LT (Light Truck)-Metric tire sizing is based on U.S. design standards. The size designation for LT-Metric tires is the same as for P-Metric tires except for the letters "LT" that are molded into the sidewall preceding the size designation. Example: LT235/85R16.
- Temporary Spare tires are high-pressure compact spares designed for temporary emergency use only. Tires designed to this standard have the letter "T" molded into the sidewall preceding the size designation. Example: T145/80D18 103M.
- High Flotation tire sizing is based on U.S. design standards and it begins with the tire diameter molded into the sidewall. Example: 31x10.5 R15 LT.

Tire Sizing Chart

EXAMPLE:	
Size Designation:	
P = Passenger car tire size based on U.S. design standards	
"...blank..." = Passenger car tire based on European design standards	
LT = Light Truck tire based on U.S. design standards	
T = Temporary Spare tire	
31 = Overall Diameter in Inches (in)	
215 = Section Width in Millimeters (mm)	
65 = Aspect Ratio in Percent (%)	
	—Ratio of section height to section width of tire.
10.5 = Section Width in Inches (in)	
R = Construction Code	
	—"R" means Radial Construction.
	—"D" means Diagonal or Bias Construction.
15 = Rim Diameter in Inches (in)	

EXAMPLE:**Service Description:****95** = Load Index

—A numerical code associated with the maximum load a tire can carry.

H = Speed Symbol

—A symbol indicating the range of speeds at which a tire can carry a load corresponding to its load index under certain operating conditions.

—The maximum speed corresponding to the Speed Symbol should only be achieved under specified operating conditions (i.e. tire pressure, vehicle loading, road conditions, and posted speed limits).

Load Identification:**"...blank..."** = Absence of any text on sidewall of the tire indicates a Standard Load (SL) Tire**Extra Load (XL)** = Extra Load (or Reinforced) Tire**Light Load** = Light Load Tire**C,D,E** = Load range associated with the maximum load a tire can carry at a specified pressure**Maximum Load** — Maximum Load indicates the maximum load this tire is designed to carry.**Maximum Pressure** — Maximum Pressure indicates the maximum permissible cold tire inflation pressure for this tire.

Tire Identification Number (TIN)

The TIN may be found on one or both sides of the tire; however, the date code may only be on one side. Tires with white sidewalls will have the full TIN including date code

located on the white sidewall side of the tire. Look for the TIN on the outboard side of black sidewall tires as mounted on the vehicle. If the TIN is not found on the outboard side then you will find it on the inboard side of the tire.

EXAMPLE:**DOT MA L9 ABCD 0301**

DOT = Department of Transportation

—This symbol certifies that the tire is in compliance with the U.S. Department of Transportation tire safety standards, and is approved for highway use.

MA = Code representing the tire manufacturing location. (2 digits)

L9 = Code representing the tire size. (2 digits)

ABCD = Code used by tire manufacturer. (1 to 4 digits)

03 = Number representing the week in which the tire was manufactured. (2 digits)

—03 means the 3rd week.

01 = Number representing the year in which the tire was manufactured. (2 digits)

—01 means the year 2001.

—Prior to July 2000, tire manufacturers were only required to have 1 number to represent the year in which the tire was manufactured. Example: 031 could represent the 3rd week of 1981 or 1991.

Tire Loading and Tire Pressure

Tire Placard Location

NOTE: The proper cold tire inflation pressure is listed on either the face of the driver's door or the driver's side "B" pillar.

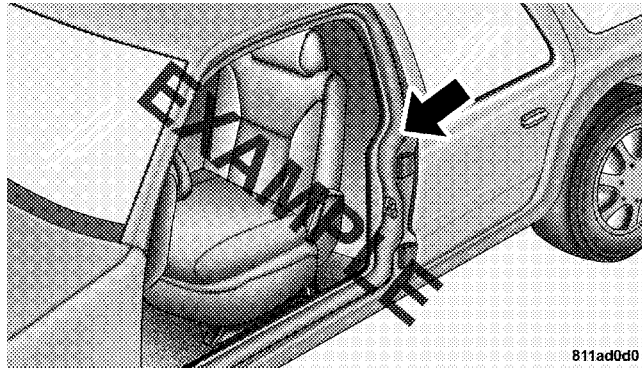

811ad0d0

Tire Placard Location

Tire and Loading Information Placard

TIRE AND LOADING INFORMATION

SEATING CAPACITY - TOTAL 5 FRONT 2 REAR 3

THE COMBINED WEIGHT OF OCCUPANTS AND CARGO SHOULD NEVER EXCEED XXX KG OR XXX LBS.

TIRE	FRONT	REAR	SPARE
ORIGINAL TIRE SIZE	P195/70R14	P195/70R14	T125/70D15
COLD TIRE INFLATION PRESSURE	200kPa, 29PSI	200kPa, 29PSI	420kPa, 60PSI

SEE OWNER'S MANUAL FOR ADDITIONAL INFORMATION

4N109268

5

811b5a9a

Tire and Loading Information

This placard tells you important information about the:

- 1) number of people that can be carried in the vehicle
- 2) the total weight your vehicle can carry
- 3) the tire size designed for your vehicle
- 4) the cold tire inflation pressures for the front, rear, and spare tires.

Loading

The vehicle maximum load on the tire must not exceed the load carrying capacity of the tire on your vehicle. You will not exceed the tire's load carrying capacity if you adhere to the loading conditions, tire size, and cold tire inflation pressures specified on the "Tire and Loading Information" placard and in the "Vehicle Loading" section of this manual.

NOTE: Under a maximum loaded vehicle condition, gross axle weight ratings (GAWR's) for the front and rear axles must not be exceeded. For further information on GAWR's, vehicle loading, and trailer towing, refer to the "Vehicle Loading" section of this manual.

To determine the maximum loading conditions of your vehicle, locate the statement "The combined weight of occupants and cargo should never exceed XXX kg or XXX lbs." on the Tire and Loading Information placard. The

combined weight of occupants, cargo/luggage and trailer tongue weight (if applicable) should never exceed the weight referenced here.

Steps for Determining Correct Load Limit

1. Locate the statement "The combined weight of occupants and cargo should never exceed XXX pounds" on your vehicle's placard.
2. Determine the combined weight of the driver and passengers that will be riding in your vehicle.
3. Subtract the combined weight of the driver and passengers from XXX kilograms or XXX pounds.
4. The resulting figure equals the available amount of cargo and luggage load capacity. For example, if "XXX" amount equals 1400 lbs. and there will be five 150 lb. passengers in your vehicle, the amount of available cargo and luggage load capacity is 650 lbs. (since $5 \times 150 = 750$, and $1400 - 750 = 650$ lbs.)

5. Determine the combined weight of luggage and cargo being loaded on the vehicle. That weight may not safely exceed the available cargo and luggage load capacity calculated in Step 4.
6. If your vehicle will be towing a trailer, load from your trailer will be transferred to your vehicle. Consult this manual to determine how this reduces the available cargo and luggage load capacity of your vehicle.

NOTE: The following table shows examples on how to calculate total load, cargo/luggage, and towing capacities of your vehicle with varying seating configurations and number and size of occupants. This table is for illustration purposes only and may not be accurate for the seating and load carry capacity of your vehicle.

NOTE: For the following example, the combined weight of occupants and cargo should never exceed 865 lbs. (392 kg).

314 STARTING AND OPERATING

Occupants			Combined weight of occupants and cargo from Tire Placard	MINUS	Combined Occupant's weight	=	AVAILABLE Cargo/Luggage and Trailer Tongue Weight
TOTAL	FRONT	REAR					
EXAMPLE 1			865 lbs	minus	670 lbs	=	195 lbs
5	2	3					
EXAMPLE 2			865 lbs	minus	540 lbs	=	325 lbs
3	2	1					
EXAMPLE 3			865 lbs	minus	400 lbs	=	465 lbs
2	2	0					

Occupant 1: 200 lbs
 Occupant 2: 130 lbs
 Occupant 3: 160 lbs
 Occupant 4: 100 lbs
 Occupant 5: 80 lbs
 TOTAL WEIGHT: 670 lbs

Occupant 1: 210 lbs
 Occupant 2: 180 lbs
 Occupant 3: 150 lbs
 TOTAL WEIGHT: 540 lbs

Occupant 1: 200 lbs
 Occupant 2: 200 lbs
 TOTAL WEIGHT: 400 lbs

EXAMPLE

811a4d11

WARNING!

Overloading of your tires is dangerous. Overloading can cause tire failure, affect vehicle handling, and increase your stopping distance. Use tires of the recommended load capacity for your vehicle. Never overload them.

TIRES — GENERAL INFORMATION**Tire Pressure**

Proper tire inflation pressure is essential to the safe and satisfactory operation of your vehicle. Three primary areas are affected by improper tire pressure:

1. Safety—**WARNING!**

- Improperly inflated tires are dangerous and can cause accidents.
- Under inflation increases tire flexing and can result in tire failure.
- Over inflation reduces a tire's ability to cushion shock. Objects on the road and chuckholes can cause damage that result in tire failure.
- Unequal tire pressures can cause steering problems. You could lose control of your vehicle.
- Over inflated or under inflated tires can affect vehicle handling and can fail suddenly, resulting in loss of vehicle control.
- Unequal tire pressures from one side of the vehicle to the other can cause the vehicle to drift to the right or left.
- Always drive with each tire inflated to the recommended cold tire inflation pressure.

2. *Economy*—

Improper inflation pressures can cause uneven wear patterns to develop across the tire tread. These abnormal wear patterns will reduce tread life resulting in a need for earlier tire replacement. Under inflation also increases tire rolling resistance and results in higher fuel consumption.

3. *Ride Comfort and Vehicle Stability*—

Proper tire inflation contributes to a comfortable ride. Over inflation produces a jarring and uncomfortable ride. Both under inflation and over inflation affect the stability of the vehicle and can produce a feeling of sluggish response or over responsiveness in the steering.

Unequal tire pressures can cause erratic and unpredictable steering response.

Unequal tire pressure from side to side may cause the vehicle to drift left or right.

Tire Inflation Pressures

The proper cold tire inflation pressure is listed on either the face of the driver's door or the driver's side "B" pillar.

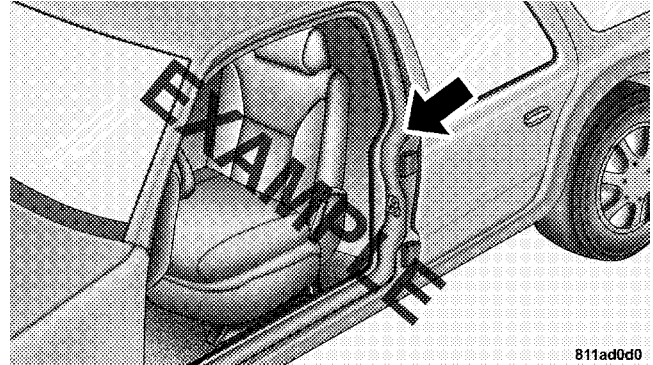

Tire Placard Location

The pressure should be checked and adjusted as well as inspecting for signs of tire wear or visible damage at least once a month. Use a good quality pocket-type gauge to

check tire pressure. Do not make a visual judgement when determining proper inflation. Radial tires may look properly inflated even when they are under inflated.

CAUTION!

After inspecting or adjusting the tire pressure, always reinstall the valve stem cap (if equipped). This will prevent moisture and dirt from entering the valve stem, which could damage the valve stem.

Inflation pressures specified on the placard are always “cold tire inflation pressure.” Cold tire inflation pressure is defined as the tire pressure after the vehicle has not been driven for at least 3 hours, or driven less than 1 mile (1 km) after a 3 hour period. The cold tire inflation pressure must not exceed the maximum inflation pressure molded into the tire sidewall.

Check tire pressures more often if subject to a wide range of outdoor temperatures, as tire pressures vary with temperature changes.

Tire pressures change by approximately 1 psi (7 kPa) per 12° F (7° C) of air temperature change. Keep this in mind when checking tire pressure inside a garage, especially in the winter.

Example: If garage temperature = 68° F (20° C) and the outside temperature = 32° F (0° C) then the cold tire inflation pressure should be increased by 3 psi (21 kPa), which equals 1 psi (7 kPa) for every 12° F (7° C) for this outside temperature condition.

Tire pressure may increase from 2 to 6 psi (13 to 40 kPa) during operation. DO NOT reduce this normal pressure build up or your tire pressure will be too low.

Tire Pressures for High Speed Operation

The manufacturer advocates driving at safe speeds within posted speed limits. Where speed limits or conditions are such that the vehicle can be driven at high speeds, maintaining correct tire inflation pressure is very important. Increased tire pressure and reduced vehicle loading may be required for high-speed vehicle operation. Refer to original equipment or an authorized tire dealer for recommended safe operating speeds, loading and cold tire inflation pressures.

WARNING!

High speed driving with your vehicle at or above maximum load is dangerous. The added strain on your tires could cause them to fail. You could have a serious accident. Don't drive a vehicle loaded to the maximum capacity at continuous speeds above 75 mph (120 km/h).

Radial-Ply Tires

WARNING!

Combining radial ply tires with other types of tires on your vehicle will cause your vehicle to handle poorly. The instability could cause an accident. Always use radial tires in sets of four. Never combine them with other types of tires.

Cuts and punctures in radial tires are repairable only in the tread area because of sidewall flexing. Consult your dealer for radial tire repairs.

Tire Spinning

When stuck in mud, sand, snow, or ice conditions, do not spin your vehicle's wheels above 35 mph (55 km/h).

WARNING!

Fast spinning tires can be dangerous. Forces generated by excessive wheel speeds may cause tire damage or failure. A tire could explode and injure someone. Do not spin your vehicle's wheels faster than 35 mph (55 km/h) when you are stuck, and do not let anyone near a spinning wheel no matter what the speed.

Tread Wear Indicators

Tread wear indicators are in the original equipment tires to help you in determining when your tires should be replaced.

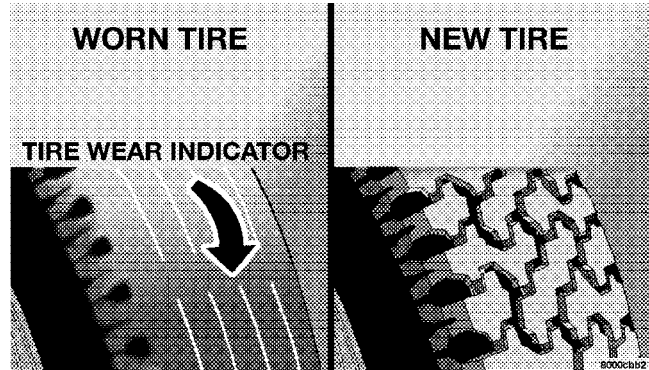

These indicators are molded into the bottom of the tread grooves. They will appear as bands when the tread depth becomes 1/16 inch (2 mm). When the indicators appear in 2 or more adjacent grooves, the tire should be replaced.

Many states have laws requiring tire replacement at this point.

Life of Tire

The service life of a tire is dependent upon varying factors including but not limited to:

- Driving style
- Tire pressure
- Distance driven

WARNING!

Tires and spare tire should be replaced after six years, regardless of the remaining tread. Failure to follow this warning can result in sudden tire failure. You could lose control and have an accident resulting in serious injury or death.

Keep dismantled tires in a cool, dry place with as little exposure to light as possible. Protect tires from contact with oil, grease, and gasoline.

Replacement Tires

The tires on your new vehicle provide a balance of many characteristics. They should be inspected regularly for wear and correct cold tire inflation pressure. The manufacturer strongly recommends that you use tires equivalent to the originals in size, quality and performance when replacement is needed (refer to the paragraph on “Tread Wear Indicators”). Refer to the “Tire and Loading Information” placard for the size designation of your tire. The service description and load identification will be found on the original equipment tire. Failure to use equivalent replacement tires may adversely affect the safety, handling, and ride of your vehicle. We recommend that you contact your original equipment or an authorized tire dealer with any questions you may have on tire specifications or capability.

WARNING!

- **Do not use a tire, wheel size or rating other than that specified for your vehicle. Some combinations of unapproved tires and wheels may change suspension dimensions and performance characteristics, resulting in changes to steering, handling, and braking of your vehicle. This can cause unpredictable handling and stress to steering and suspension components. You could lose control and have an accident resulting in serious injury or death. Use only the tire and wheel sizes with load ratings approved for your vehicle.**
- **Never use a tire with a smaller load index or capacity, other than what was originally equipped on your vehicle. Using a tire with a smaller load index could result in tire overloading and failure. You could lose control and have an accident.**
- **Failure to equip your vehicle with tires having adequate speed capability can result in sudden tire failure and loss of vehicle control.**

CAUTION!

Replacing original tires with tires of a different size may result in false speedometer and odometer readings.

Alignment and Balance

Poor suspension alignment may result in:

- Fast tire wear.
- Uneven tire wear, such as feathering and one-sided wear.
- Vehicle pull to right or left.

Tires may also cause the vehicle to pull left or right. Alignment will not correct this problem. See your authorized dealer for proper diagnosis.

Improper alignment will not cause vehicle vibration. Vibration may be a result of tire and wheel out-of-balance. Proper balancing will reduce vibration and avoid tire cupping and spotty wear.

TIRE CHAINS

Only models fitted with 235/65R17XL (extra load) tires have sufficient tire-to-body clearance to allow use of tire chains. **Install chains on rear tires only.** Follow these recommendations to guard against damage and excessive tire and chain wear:

- Do not install tire chains or traction devices on vehicles with larger than 235/65R17XL size tires. Tires larger than this may not provide sufficient body clearance with chains or other traction devices.
- Manufacturer recommends a cold inflation pressure of 38 psi (262 kPa) when using 235/65R17XL size tires for this vehicle.

- Use SAE class “S” tire chains or traction devices only.
- Follow tire chain manufacturer’s instructions for mounting chains.
- Install chains snugly and tighten after 1/2 mile (1 km) of driving.
- **Do not** exceed 30 mph (48 km/h), unless otherwise specified by the chain manufacturer.
- Drive cautiously, avoiding large bumps, potholes and extreme driving maneuvers.

TIRE ROTATION RECOMMENDATIONS

Tires on the front and rear axles of vehicles operate at different loads and perform different steering, handling, and braking functions. For these reasons, they wear at unequal rates, and develop irregular wear patterns.

These effects can be reduced by timely rotation of tires. The benefits of rotation are especially worthwhile with

aggressive tread designs such as those on On/Off Road type tires. Rotation will increase tread life, help to maintain mud, snow, and wet traction levels, and contribute to a smooth, quiet ride.

Follow the recommended tire rotation frequency for your type of driving found in the “Maintenance Schedules” Section of this manual. More frequent rotation is permissible if desired. The reasons for any rapid or unusual wear should be corrected prior to rotation being performed.

NOTE: The Premium Tire Pressure Monitor System will automatically locate the pressure values displayed in the correct vehicle position following a tire rotation.

The suggested rotation method is the “forward-cross” shown in the following diagram.

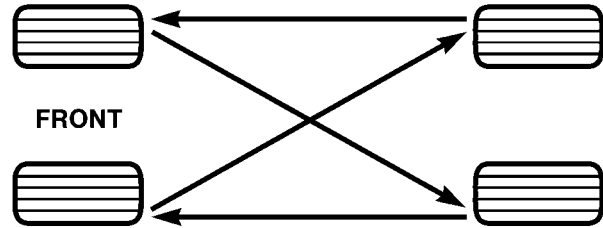

8031e864

TIRE PRESSURE MONITOR SYSTEM (TPMS)

The Tire Pressure Monitoring System (TPMS) will warn the driver of a low tire pressure based on the vehicle recommended cold tire pressure.

The tire pressure will vary with temperature by about 1 psi (7 kPa) for every 12°F (-11°C). This means that when the outside temperature decreases, the tire pressure will

decrease. Tire pressure should always be set based on cold inflation tire pressure. This is defined as the tire pressure after the vehicle has not been driven for at least 3 hours, or driven less than 1 mile (1 km) after a 3 hour period. **Refer to the “Tires – General Information” in this section for information on how to properly inflate the vehicle’s tires.** The tire pressure will also increase as the vehicle is driven - this is normal and there should be no adjustment for this increased pressure.

The TPM System will warn the driver of a low tire pressure if the tire pressure falls below the low pressure warning threshold for any reason, including low temperature effects, or natural pressure loss through the tire.

The TPM System will continue to warn the driver of low tire pressure as long as the condition exists, and will not turn off until the tire pressure is at or above recommended cold tire pressure. Once the low tire pressure warning has been illuminated, the tire pressure must be

increased to the recommended cold tire pressure in order for the “Tire Pressure Monitoring Telltale Light” to be turned off. The system will automatically update and the “Tire Pressure Monitoring Telltale Light” will extinguish once the updated tire pressures have been received. The vehicle may need to be driven for up to 10 minutes above 15 mph (24 km/h) to receive this information.

For example, your vehicle has a recommended cold (parked for more than 3 hours) tire pressure of 35 psi (241 kPa). If the ambient temperature is 68°F (20°C) and the measured tire pressure is 30 psi (207 kPa), a temperature drop to 20°F (-7°C) will decrease the tire pressure to approximately 26 psi (179 kPa). This tire pressure is sufficiently low enough to turn ON the “Tire Pressure Monitoring Telltale Light.” Driving the vehicle may cause the tire pressure to rise to approximately 30 psi (207 kPa), but the “Tire Pressure Monitoring Telltale Light” will still be ON. In this situation, the “Tire Pressure Monitoring

Telltale Light” will turn OFF only after the tires have been inflated to the vehicle’s recommended cold tire pressure value.

CAUTION!

The TPMS has been optimized for the original equipment tires and wheels. TPMS pressures have been established for the tire size equipped on your vehicle. Undesirable system operation or sensor damage may result when using replacement equipment that is not of the same size, type, and/or style. Aftermarket wheels can cause sensor damage. Do not use aftermarket tire sealants or balance beads if your vehicle is equipped with a TPMS, as damage to the sensors may result.

CAUTION!

After inspecting or adjusting the tire pressure always reinstall the valve stem cap. This will prevent moisture and dirt from entering the valve stem, which could damage the Tire Pressure Monitoring Sensor.

NOTE:

- The TPMS is not intended to replace normal tire care and maintenance, or to provide warning of a tire failure or condition.
- The TPMS should not be used as a tire pressure gauge while adjusting your tire pressure.
- Driving on a significantly under-inflated tire causes the tire to overheat and can lead to tire failure. Under-inflation also reduces fuel efficiency and tire tread life, and may affect the vehicle’s handling and stopping ability.

- The TPMS is not a substitute for proper tire maintenance, and it is the driver's responsibility to maintain correct tire pressure using an accurate tire gauge, even if under-inflation has not reached the level to trigger illumination of the "Tire Pressure Monitoring Telltale Light."
- Seasonal temperature changes will affect tire pressure, and the TPM system will monitor the actual tire pressure in the tire.

Base System — If Equipped

The Tire Pressure Monitor System (TPMS) uses wireless technology with wheel rim mounted electronic sensors to monitor tire pressure levels. Sensors, mounted to each wheel as part of the valve stem, transmit tire pressure readings to the Receiver Module.

NOTE: It is particularly important, for you to check the tire pressure in all of your tires regularly and to maintain the proper pressure.

The Tire Pressure Monitor System (TPMS) consists of the following components:

- Receiver Module
- 4 Tire Pressure Monitoring Sensors
- Tire Pressure Monitoring Telltale Light

A tire pressure monitoring sensor is located in the spare wheel if the vehicle is equipped with a matching full size spare wheel and tire assembly. The matching full size spare tire can be used in place of any of the four road tires. A low spare tire will not cause the "Tire Pressure Monitoring Telltale Light" to illuminate or the chime to sound.



The "Tire Pressure Monitoring Telltale Light" will illuminate in the instrument cluster, and an audible chime will be activated when one or more of the four active road tire pressures are low. Should this occur, you should stop as soon as possible, check the

inflation pressure of each tire on your vehicle, and inflate each tire to the vehicle's recommended cold placard pressure value. The system will automatically update and the "Tire Pressure Monitoring Telltale Light" will extinguish once the updated tire pressures have been received. The vehicle may need to be driven for up to 10 minutes above 15 mph (24 km/h) to receive this information.

The "Tire Pressure Monitoring Telltale Light" will flash on and off for 75 seconds, and remain on solid when a system fault is detected. The system fault will also sound a chime. If the ignition key is cycled, this sequence will repeat, providing the system fault still exists. The Tire Pressure Monitoring Telltale Lamp will turn off when the fault condition no longer exists. A system fault can occur by any of the following scenarios:

1. Jamming due to electronic devices or driving next to facilities emitting the same Radio Frequencies as the TPM sensors.
2. Installing some form of aftermarket window tinting that affects radio wave signals.
3. Lots of snow or ice around the wheels or wheel housings.
4. Using tire chains on the vehicle.
5. Using wheels/tires not equipped with TPM sensors.

NOTE: If your vehicle is equipped with a matching full size spare wheel and tire assembly, it has a tire pressure monitoring sensor, and can be monitored by the Tire Pressure Monitoring System (TPMS). In the event that the matching full size spare tire is swapped with a low pressure road tire, the next ignition key cycle will still show the "Tire Pressure Monitoring Telltale Light" to be ON, and a chime to sound. Driving the vehicle for up to

10 minutes above 15 mph (24 km/h) will turn OFF the “Tire Pressure Monitoring Telltale Light” as long as none of the road tires are below the low pressure warning threshold.

NOTE: If your vehicle is not equipped with a matching full size spare wheel and tire assembly, it does not have a tire pressure monitoring sensor in the spare tire. The TPMS will not be able to monitor the tire pressure. If you install the spare tire in place of a road tire that has a pressure below the low-pressure warning limit, upon the next ignition key cycle, a chime will sound and the “Tire Pressure Monitoring Telltale Light” will turn ON. After driving the vehicle for up to 10 minutes above 15 mph (25 km/h), the “Tire Pressure Monitoring Telltale Light” will flash on and off for 75 seconds and then remain on solid. For each subsequent ignition key cycle, a chime will sound and the “Tire Pressure Monitoring Telltale Light” will flash on and off for 75 seconds and then remain on solid. Once you repair or replace the original road tire,

and reinstall it on the vehicle in place of the spare tire, the TPMS will update automatically and the “Tire Pressure Monitoring Telltale Light” will turn OFF, as long as no tire pressure is below the low-pressure warning limit in any of the four active road tires. The vehicle may need to be driven for up to 10 minutes above 15 mph (24 km/h) in order for the TPMS to receive this information.

Premium System — If Equipped

The Tire Pressure Monitor System (TPMS) uses wireless technology with wheel rim mounted electronic sensors to monitor tire pressure levels. Sensors, mounted to each wheel as part of the valve stem, transmit tire pressure readings to the Receiver Module.

NOTE: It is particularly important, for you to check the tire pressure in all of your tires regularly and to maintain the proper pressure.

The Tire Pressure Monitor System (TPMS) consists of the following components:

- Receiver Module
- 4 Tire Pressure Monitoring Sensors
- 3 Trigger Modules (mounted in three of the four wheel wells)
- Various Tire Pressure Monitoring System Messages, which display in the Electronic Vehicle Information Center (EVIC), and a graphic displaying tire pressures
- Tire Pressure Monitoring Telltale Light

A tire pressure monitoring sensor is located in the spare wheel if the vehicle is equipped with a matching full size spare wheel and tire assembly. The matching full size spare tire can be used in place of any of the four road

tires. A low spare tire will set the “SPARE LOW PRESURE” textual message, but it will not cause the “Tire Pressure Monitoring Telltale Light” to illuminate or the chime to sound.

Tire Pressure Monitoring Low Pressure Warnings



The “Tire Pressure Monitoring Telltale Light” will illuminate in the instrument cluster, and an audible chime will be activated when one or more of the four active road tire pressures are low. In addition, the Electronic Vehicle Information Center (EVIC) will display one or more Low Pressure messages (Left Front, Left Rear, Right Front, Right Rear) for 3 seconds, and a graphic display of the pressure value(s) with the low tire(s) flashing. Refer to “Electronic Vehicle Information Center (EVIC)” in Section 4 of this manual.

NOTE: Your system can be set to display pressure units in PSI, kPa, or BAR.

TIRE	35		34
PSI	24		34

8197133c

Should a low tire condition occur on any of the four active road tire(s), you should stop as soon as possible, and inflate the low tire(s) that is flashing on the graphic display to the vehicle's recommended cold tire pressure.

The system will automatically update, the graphic display of the pressure value(s) will stop flashing, and the "Tire Pressure Monitoring Telltale Light" will extinguish once the updated tire pressure(s) have been received. The vehicle may need to be driven for up to 10 minutes above 15 mph (24 km/h) to receive this information.

Check TPM System Message

The "Tire Pressure Monitoring Telltale Light" will flash on and off for 75 seconds, and remain on solid when a system fault is detected. The system fault will also sound a chime. The EVIC will display a "CHECK TPM SYSTEM" message for 3 seconds. This text message is then followed by a graphic display, with "- -" in place of the pressure value(s) indicating which Tire Pressure Monitoring Sensor(s) is not being received.

NOTE: Your system can be set to display pressure units in PSI, kPa, or BAR.

TIRE 35 34
 PSI -- 34



81971362

If the ignition key is cycled, this sequence will repeat, providing the system fault still exists. If the system fault no longer exists, the Tire Pressure Monitoring Telltale Light will no longer flash, the "CHECK TPM SYSTEM" text message will not be present, and a pressure value will be displayed instead of dashes. A system fault can occur by any of the following scenarios:

1. Jamming due to electronic devices or driving next to facilities emitting the same Radio Frequencies as the TPM sensors.
2. Installing some form of aftermarket window tinting that affects radio wave signals.
3. Lots of snow or ice around the wheels or wheel housings.
4. Using tire chains on the vehicle.
5. Using wheels/tires not equipped with TPM sensors.

NOTE: If your vehicle is equipped with a matching full size spare wheel and tire assembly, it has a tire pressure monitoring sensor, and can be monitored by the Tire Pressure Monitoring System (TPMS). In the event that the matching full size spare tire is swapped with a low pressure road tire, the next ignition key cycle will still show the "Tire Pressure Monitoring Telltale Light" to be ON, a chime to sound, a Low Pressure message to appear

in the EVIC, and the graphic display will still show the low tire pressure value flashing. Driving the vehicle for up to 10 minutes above 15 mph (24 km/h) will turn OFF the “Tire Pressure Monitoring Telltale Light” as long as none of road tires are below the low pressure warning threshold. The EVIC will also display a “Spare Low Pressure” text message, and the graphic display will show a tire pressure value in place of the flashing low tire pressure value.

NOTE: If your vehicle is not equipped with a matching full size spare wheel and tire assembly, it does not have a tire pressure monitoring sensor in the spare tire. The TPMS will not be able to monitor the tire pressure. If you install the spare tire in place of a road tire that has a pressure below the low-pressure warning limit, upon the next ignition key cycle, the “Tire Pressure Monitoring Telltale Light” will remain ON, a chime will sound, and the EVIC will still display a flashing pressure value in the graphic display. After driving the vehicle for up to 10

minutes above 15 mph (24 km/h), the “Tire Pressure Monitoring Telltale Light” will flash on and off for 75 seconds and then remain on solid. In addition, the EVIC will display a “CHECK TPM SYSTEM” message for 3 seconds and then display dashes (- -) in place of the pressure value. For each subsequent ignition key cycle, a chime will sound, the “Tire Pressure Monitoring Telltale Light” will flash on and off for 75 seconds and then remain on solid, and the EVIC will display a “CHECK TPM SYSTEM” message for 3 seconds and then display dashes (- -) in place of the pressure value. Once you repair or replace the original road tire, and reinstall it on the vehicle in place of the spare tire, the TPMS will update automatically.

In addition, the “Tire Pressure Monitoring Telltale Light” will turn OFF and the graphic in the EVIC will display a new pressure value instead of dashes (- -), as long as no tire pressure is below the low-pressure warning limit in any of the four active road tires. The vehicle may need to

be driven for up to 10 minutes above 15 mph (24 km/h) in order for the TPMS to receive this information.

General Information

This device complies with part 15 of the FCC rules and RSS 210 of Industry Canada. Operation is subject to the following conditions:

- This device may not cause harmful interference.
- This device must accept any interference received, including interference that may cause undesired operation.

The tire pressure sensors are covered under one of the following licenses:

United States KR5S120123
Canada 2671-S120123

FUEL REQUIREMENTS

3.7/4.7L Engines (If Equipped)



All engines (except 5.7L engines) are designed to meet all emissions regulations and provide excellent fuel economy and performance when using high quality unleaded “regular” gasoline having an octane rating of 87. The use of premium gasoline is not recommended. Under normal conditions, the use of premium gasoline will not provide a benefit over high quality regular gasolines, and in some circumstances may result in poorer performance.

5.7L Engines (If Equipped)



The 5.7L engine is designed to meet all emissions regulations and provide satisfactory fuel economy and performance when

using high quality unleaded gasoline having an octane range of 87 to 89. The manufacturer recommends the use of 89 octane for optimum performance. The use of premium gasoline is not recommended. Under normal conditions, the use of premium gasoline will not provide a benefit over high quality regular and mid-grade gasolines, and in some circumstances may result in poorer performance.

Light spark knock at low engine speeds is not harmful to your engine. However, continued heavy spark knock at high speeds can cause damage and immediate service is required.

Poor quality gasoline can cause problems such as hard starting, stalling and hesitations. If you experience these symptoms, try another brand of gasoline before considering service for the vehicle.

Over 40 auto manufacturer's world wide have issued and endorsed consistent gasoline specifications (the World-wide Fuel Charter, WWFC) to define fuel properties necessary to deliver enhanced emissions, performance, and durability for your vehicle. The manufacturer recommends the use of gasoline that meets the WWFC specifications if they are available.

Reformulated Gasoline

Many areas of the country require the use of cleaner burning gasoline referred to as "Reformulated Gasoline."

Reformulated gasoline contains oxygenates, and are specifically blended to reduce vehicle emissions and improve air quality.

The manufacturer supports the use of reformulated gasoline. Properly blended reformulated gasoline will provide excellent performance and durability of engine and fuel system components.

Gasoline/Oxygenate Blends

Some fuel suppliers blend unleaded gasoline with oxygenates such as 10% ethanol, MTBE, and ETBE. Oxygenates are required in some areas of the country during the winter months to reduce carbon monoxide emissions. Fuels blended with these oxygenates may be used in your vehicle.

CAUTION!

DO NOT use gasoline containing Methanol or E85 Ethanol. Use of these blends may result in starting and driveability problems and may damage critical fuel system components.

Problems that result from using methanol/gasoline blends are not the responsibility of the manufacturer. While MTBE is an oxygenate made from Methanol, it does not have the negative effects of Methanol.

MMT In Gasoline

MMT is a manganese containing metallic additive that is blended into some gasoline to increase octane. Gasoline blended with MMT provides no performance advantage beyond gasoline of the same octane number without MMT. Gasoline blended with MMT reduces spark plug life and reduces emission system performance in some vehicles. The manufacturer recommends that gasoline without MMT be used in your vehicle. The MMT content of gasoline may not be indicated on the gasoline pump, therefore, you should ask your gasoline retailer whether or not his/her gasoline contains MMT.

It is even more important to look for gasolines without MMT in Canada, because MMT can be used at levels higher than those allowed in the United States.

MMT is prohibited in Federal and California reformulated gasoline.

Materials Added To Fuel

All gasoline sold in the United States is required to contain effective detergent additives. Use of additional detergents or other additives is not needed under normal conditions and would result in additional cost. Therefore you should not have to add anything to the fuel.

Fuel System Cautions

CAUTION!
Follow these guidelines to maintain your vehicle's performance:

- The use of leaded gas is prohibited by Federal law. Using leaded gasoline can impair engine performance, damage the emission control system.

- An out-of-tune engine, or certain fuel or ignition malfunctions, can cause the catalytic converter to overheat. If you notice a pungent burning odor or some light smoke, your engine may be out of tune or malfunctioning and may require immediate service. Contact your dealer for service assistance.
- The use of fuel additives which are now being sold as octane enhancers is not recommended. Most of these products contain high concentrations of methanol. Fuel system damage or vehicle performance problems resulting from the use of such fuels or additives is not the responsibility of the manufacturer.

NOTE: Intentional tampering with emissions control systems can result in civil penalties being assessed against you.

Carbon Monoxide Warnings

WARNING!

Carbon monoxide (CO) in exhaust gases is deadly. Follow the precautions below to prevent carbon monoxide poisoning:

- Do not inhale exhaust gases. They contain carbon monoxide, a colorless and odorless gas which can kill. Never run the engine in a closed area, such as a garage, and never sit in a parked vehicle with the engine running for an extended period. If the vehicle is stopped in an open area with the engine running for more than a short period, adjust the ventilation system to force fresh, outside air into the vehicle.
- Guard against carbon monoxide with proper maintenance. Have the exhaust system inspected every time

the vehicle is raised. Have any abnormal conditions repaired promptly. Until repaired, drive with all side windows fully open.

- Keep the liftgate closed when driving your vehicle to prevent carbon monoxide and other poisonous exhaust gases from entering the vehicle.

FLEXIBLE FUEL (4.7L ENGINE ONLY) — IF EQUIPPED

E-85 General Information

The information in this section is for Flexible Fuel vehicles only. These vehicles can be identified by a unique, yellow fuel filler cap (gas cap) that states **Ethanol (E-85)/Unleaded Gasoline**, and by the **FLEXFUEL** badge that will be located on the body of your vehicle. This section only covers those subjects that are unique to these vehicles. Please refer to the other sections of this manual for information on features that are common between Flexible Fuel and gasoline only powered vehicles.

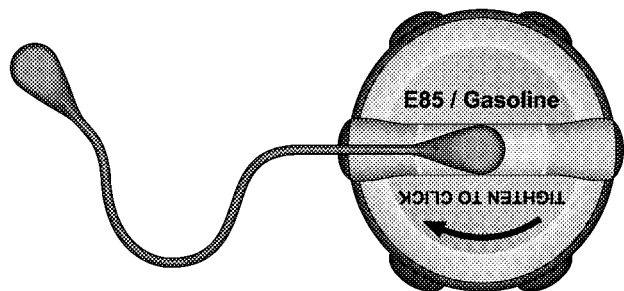

81ae46ab

E-85 Fuel Cap

CAUTION!

Only vehicles with the E-85 fuel filler cap (gas cap) can operate on E-85.



81ae46a9

E-85 Badge

ETHANOL FUEL (E-85)

E-85 is a mixture of approximately 85% fuel ethanol and 15% unleaded gasoline.

WARNING!

Ethanol vapors are extremely flammable and could cause serious personal injury. Never have any smoking materials lit in or near the vehicle when removing the fuel filler tube cap (gas cap) or filling the tank. Do not use E-85 as a cleaning agent and never use it near an open flame.

Fuel Requirements

Your vehicle will operate on both unleaded gasoline with an octane rating of 87, or E-85 fuel, or any mixture of these two.

For best results, a refueling pattern that alternates between E-85 and unleaded gasoline should be avoided. When you do switch fuels, it is recommended that

- you do not switch when the fuel gauge indicates less than 1/4 full
- you do not add less than 5 gallons when refueling
- you operate the vehicle immediately after refueling for a period of at least 5 minutes

Observing these precautions will avoid possible hard starting and/or significant deterioration in drivability during warm up.

NOTE: When the ambient temperature is above 90°F (32°C), you may experience hard starting and rough idle following start up even if the above recommendations are followed.

Selection Of Engine Oil For Flexible Fuel Vehicles (E-85) and Gasoline Vehicles

Whether operating the vehicle on an E-85 ethanol fuel or unleaded gasoline the engine oil requirements are the same. Refer to “Maintenance Procedures” in Section 7 of this manual for the proper quality and viscosity engine oil.

Starting

The characteristics of E-85 fuel make it unsuitable for use when ambient temperatures fall below 0°F (-18°C). In the range of 0°F (-18°C) to 32°F (0°C), you may experience an increase in the time it takes for your engine to start, and a deterioration in drivability (sags and/or hesitations) until the engine is fully warmed up.

Cruising Range

Because E-85 fuel contains less energy per gallon than gasoline, you will experience an increase in fuel consumption. You can expect your MPG and your driving range to decrease by about 30% compared to gasoline operation.

Replacement Parts

Many components in your Flexible Fuel Vehicle (FFV) are designed to be compatible with ethanol. Always be sure that your vehicle is serviced with correct ethanol compatible parts.

CAUTION!

- Replacing fuel system components with non-ethanol compatible components can damage your vehicle.
- Do not use ethanol mixture greater than 85% in your vehicle. It will cause difficulty in cold starting and may affect drivability.

ADDING FUEL**Fuel Filler Cap (Gas Cap)**

The gas cap is located behind the fuel filler door, on the driver's side of the vehicle. If the gas cap is lost or damaged, be sure the replacement cap is for use with this vehicle.

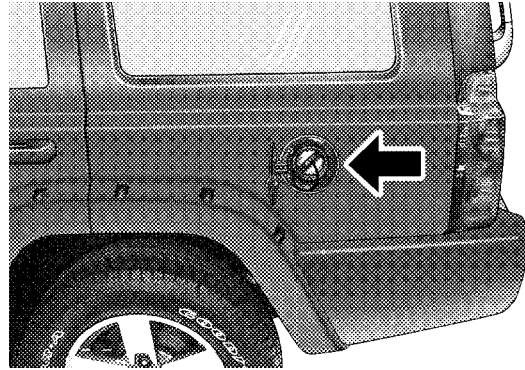
**Fuel Filler Cap Location**

81607157

CAUTION!

Damage to the fuel system or emission control system could result from using an improper fuel cap (gas cap). A poorly fitting cap could let impurities into the fuel system. Also, a poorly fitting after-market cap can cause the MIL (Malfunction Indicator Light) to illuminate, due to fuel vapors escaping from the system.

CAUTION!

A poorly fitting gas cap may cause the Malfunction Indicator Light to turn on.

CAUTION!

To avoid fuel spillage and overfilling, do not “top off” the fuel tank after filling.

NOTE: When the fuel nozzle “clicks” or shuts off, the fuel tank is full.

WARNING!

- Never have any smoking materials lit in or near the vehicle when the gas cap is removed or the tank filled.
- Never add fuel when the engine is running. This is in violation of most state and federal fire regulations and will cause the malfunction indicator light to turn on.

NOTE: Tighten the gas cap about 1/4 turn until you hear one click. This is an indication that cap is properly tightened.

If the gas cap is not tighten properly, the Malfunction Indicator Light will come on. Be sure the gas cap is tightened every time the vehicle is refueled.

Loose Fuel Filler Cap Message

If the vehicle diagnostic system determines that the fuel filler cap is loose, improperly installed, or damaged, a “CHECK GASCAP” message will be displayed in the EVIC (Electronic Vehicle Information Center). Refer to “Electronic Vehicle Information Center” in Section 4 of this manual. Tighten the fuel filler cap until a “clicking” sound is heard. This is an indication that the fuel filler cap is properly tightened. Refer to “Onboard Diagnostic System — OBDII” in Section 7 of this manual for more information.

WARNING!

A fire may result if gasoline is pumped into a portable container that is inside of a vehicle. You could be burned. Always place gas containers on the ground while filling.

CAUTION!

Damage to the fuel system or emission control system could result from using an improper fuel tank filler cap (gas cap). A poorly fitting cap could let impurities into the fuel system.

WARNING!

- Never add fuel when the engine is running.
- Never have any smoking materials lit in or near the vehicle when the fuel cap is removed or the tank filled.

VEHICLE LOADING**Certification Label**

As required by National Highway Traffic Safety Administration Regulations, your vehicle has a certification label affixed to the driver's side door or pillar.

This label contains the month and year of manufacture, Gross Vehicle Weight Rating (GVWR), Gross Axle Weight Rating (GAWR) front and rear, and Vehicle Identification Number (VIN). A Month-Day-Hour (MDH) number is included on this label and indicates the Month, Day, and

Hour of manufacture. The bar code that appears on the bottom of the label is your Vehicle Identification Number (VIN).

Gross Vehicle Weight Rating (GVWR)

The GVWR is the total permissible weight of your vehicle including driver, passengers, vehicle, options, trailer tongue weight, and cargo. The label also specifies maximum capacities of front and rear axle systems (GAWR). Total load must be limited, so GVWR, and front and rear GAWR are not exceeded.

Payload

The payload of a vehicle is defined as the allowable load weight a truck can carry, including the weight of the driver, all passengers, options and cargo.

Gross Axle Weight Rating (GAWR)

The GAWR is the maximum permissible load on the front and rear axles. The load must be distributed in the cargo area so that the GAWR of each axle is not exceeded.

Each axle GAWR is determined by the components in the system with the lowest load carrying capacity (axle, springs, tires, or wheels). Heavier axles or suspension components sometimes specified by purchasers for increased durability does not necessarily increase the vehicle's GVWR.

Tire Size

The tire size on the Label represents the actual tire size on your vehicle. Replacement tires must be equal to the load capacity of this tire size.

Rim Size

This is the rim size that is appropriate for the tire size listed.

Inflation Pressure

This is the cold tire inflation pressure for your vehicle for all loading conditions up to full GAWR.

Curb Weight

The curb weight of a vehicle is defined as the total weight of the vehicle with all fluids, including vehicle fuel, at full capacity conditions, and with no occupants or cargo loaded into the vehicle. The front and rear curb weight values are determined by weighing your vehicle on a commercial scale before any occupants or cargo are added.

Loading

The actual total weight and the weight of the front and rear of your vehicle at the ground can best be determined by weighing it when it is loaded and ready for operation.

The entire vehicle should first be weighed on a commercial scale to insure that the GVWR has not been exceeded. The weight on the front and rear of the vehicle should then be determined separately to be sure that the load is properly distributed over front and rear axle. Weighing the vehicle may show that the GAWR of either the front

or rear axles has been exceeded but the total load is within the specified GVWR. If so, weight must be shifted from front to rear or rear to front as appropriate until the specified weight limitations are met. Store the heavier items down low and be sure that the weight is distributed equally. Stow all loose items securely before driving.

Improper weight distributions can have an adverse effect on the way your vehicle steers and handles and the way the brakes operate.

CAUTION!

Do not load your vehicle any heavier than the GVWR or the maximum front and rear GAWR. If you do, parts on your vehicle can break, or it can change the way your vehicle handles. This could cause you to lose control. Also overloading can shorten the life of your vehicle.

TRAILER TOWING

In this section you will find safety tips and information on limits to the type of towing you can reasonably do with your vehicle. Before towing a trailer carefully review this information to tow your load as efficiently and safely as possible.

To maintain warranty coverage, follow the requirements and recommendations in this manual concerning vehicles used for trailer towing.

Common Towing Definitions

The following trailer towing related definitions will assist you in understanding the following information:

Gross Vehicle Weight Rating (GVWR)

The GVWR is the total allowable weight of your vehicle. This includes driver, passengers, cargo and tongue weight. The total load must be limited so that you do not exceed the GVWR.

Gross Trailer Weight (GTW)

The gross trailer weight (GTW) is the weight of the trailer plus the weight of all cargo, consumables and equipment (permanent or temporary) loaded in or on the trailer in its "loaded and ready for operation" condition. The recommended way to measure GTW is to put your fully loaded trailer on a vehicle scale. The entire weight of the trailer must be supported by the scale.

Gross Combination Weight Rating (GCWR)

The gross combination weight rating (GCWR) is the total permissible weight of your vehicle and trailer when weighed in combination. (Note that GCWR ratings include a 150 lbs (68 kg) allowance for the presence of a driver).

Gross Axle Weight Rating (GAWR)

The GAWR is the maximum capacity of the front and rear axles. Distribute the load over the front and rear axles evenly. Make sure that you do not exceed either front or rear GAWR.

WARNING!

It is important that you do not exceed the maximum front or rear GAWR. A dangerous driving condition can result if either rating is exceeded. You could lose control of the vehicle and have an accident.

5

Tongue Weight (TW)

The downward force exerted on the hitch ball by the trailer. In most cases it should not be less than 10% or more than 15% of the trailer load. You must consider this as part of the load on your vehicle.

Frontal Area

The maximum height and maximum width of the front of a trailer.

Weight-Carrying Hitch

A weight-carrying hitch supports the trailer tongue weight, just as if it were luggage located at a hitch ball or some other connecting point of the vehicle. These kind of hitches are the most popular on the market today and they're commonly used to tow small- and medium-sized trailers.

Weight-Distributing Hitch

A weight-distributing system works by applying leverage through spring (load) bars. They are typically used for heavier loads, to distribute trailer tongue weight to the tow vehicle's front axle and the trailer axle(s). When used in accordance with the manufacturers' directions, it provides for a more level ride, offering more consistent steering and brake control thereby enhancing towing

safety. The addition of a friction/hydraulic sway control also dampens sway caused by traffic and crosswinds and contributes positively to tow vehicle and trailer stability. Trailer sway control and a weight distributing (load equalizing) hitch are recommended for heavier Tongue Weights (TW) and may be required depending on Vehicle and Trailer configuration/loading to comply with gross axle weight rating (GAWR) requirements.

WARNING!

An improperly adjusted Weight Distributing Hitch system may reduce handling, stability, braking performance, and could result in an accident.

Weight Distributing Systems may not be compatible with Surge Brake Couplers. Consult with your hitch and trailer manufacturer or a reputable Recreational Vehicle dealer for additional information.

EXAMPLE ONLY

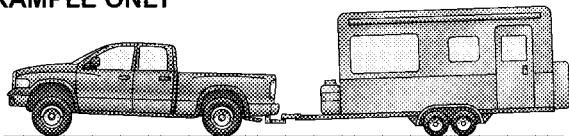

FIG. 1 WITHOUT WEIGHT DISTRIBUTION

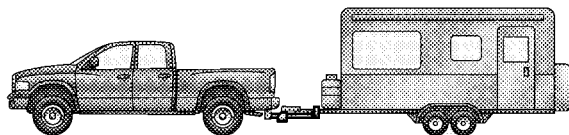

FIG. 2. WITH WEIGHT DISTRIBUTION

8181f965

Weight Distributing Hitch System

EXAMPLE ONLY

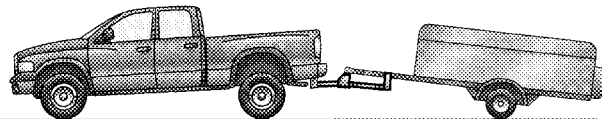

FIG. 3 IMPROPER ADJUSTMENT (INCORRECT)

8181f96f

Improper Adjustment of Weight Distributing System

Trailer Hitch Classification

Your vehicle may be factory equipped for safe towing of trailers weighing over 3,500 lbs (1 587 kg) with the optional Trailer Tow Prep Package. See your dealer for package content.

The following chart provides the industry standard for the maximum trailer weight a given trailer hitch class can tow and should be used to assist you in selecting the correct trailer hitch for your intended towing condition. Refer to the Trailer Towing Weights (Maximum Trailer Weight Ratings) chart for the Max. GTW towable for your given drivetrain.

Trailer Hitch Classification	
Class	Max. GTW (Gross Trailer Wt.)
Class I - Light Duty	2,000 lbs (907 kg)
Class II - Medium Duty	3,500 lbs (1 587 kg)
Class III - Heavy Duty	5,000 lbs (2 268 kg)
Class IV - Extra Heavy Duty	10,000 lbs (4 540 kg)

All trailer hitches should be professionally installed on your vehicle.

Trailer Towing Weights (Maximum Trailer Weight Ratings)

The following chart provides the maximum trailer weight ratings towable for your given drivetrain.

Engine/ Transmission	Model	GCWR (Gross Combined Wt. Rating)	Frontal Area	Max. GTW (Gross Trailer Wt.)	Max. Tongue Wt. (See Note 1)
3.7L/ Automatic	4x2	8,670 lbs (3 933 kg)	40 Sq. Ft (3.72 square meters)	3,500 lbs (1 587 kg)	350 lbs (159 kg)
3.7L/ Automatic	4x4	8,755 lbs (3 971 kg)	40 Sq. Ft (3.72 square meters)	3,500 lbs (1 587 kg)	350 lbs (159 kg)
4.7L/ Automatic	4x2	11,665 lbs (5 291 kg)	60 Sq. Ft (5.57 square meters)	6,500 lbs (2 948 kg)	650 lbs (295 kg)
4.7L/ Automatic	4x4	11,800 lbs (5 352 kg)	60 Sq. Ft (5.57 square meters)	6,500 lbs (2 948 kg)	650 lbs (295 kg)
5.7L/ Automatic	4x2	12,470 lbs (5 656 kg)	60 Sq. Ft (5.57 square meters)	7,200 lbs (3 266 kg)	720 lbs (327 kg)
5.7L/ Automatic	4x4	12,620 lbs (5 724 kg)	60 Sq. Ft (5.57 square meters)	7,200 lbs (3 266 kg)	720 lbs (327 kg)
Refer to local laws for maximum trailer towing speeds.					

NOTE: The trailer tongue weight must be considered as part of the combined weight of occupants and cargo, and should never exceed the weight referenced on the Tire

and Loading Information placard. Refer to the “Tire-Safety Information” section in this manual.

Trailer and Tongue Weight

Always load a trailer with 60% to 65% of the weight in the front of the trailer. This places 10% to 15% of the Gross Trailer Weight (GTW) on the tow hitch of your vehicle. Loads balanced over the wheels or heavier in the rear can cause the trailer to sway **severely** side to side which will cause loss of control of vehicle and trailer. Failure to load trailers heavier in front is the cause of many trailer accidents.

Never exceed the maximum tongue weight stamped on your trailer hitch.

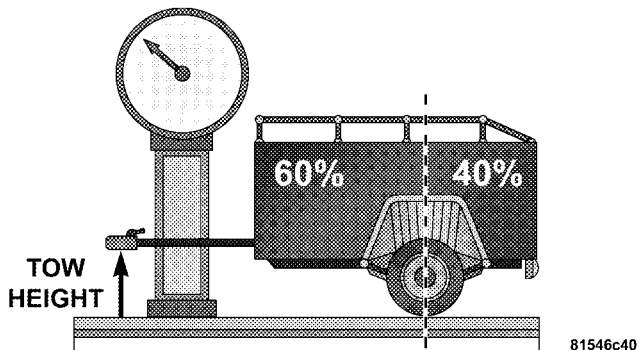

Consider the following items when computing the weight on the front/rear axles of the vehicle:

- The tongue weight of the trailer.
- The weight of any other type of cargo or equipment put in or on your vehicle.
- The weight of the driver and all passengers.

NOTE: Remember that everything put into or on the trailer adds to the load on your vehicle. Also, additional factory-installed options, or dealer-installed options, must be considered as part of the total load on your vehicle. Refer to the Tire and Loading Information placard in the “Tire—Safety Information” section of this manual for the maximum combined weight of occupants and cargo for your vehicle.

Towing Requirements

To promote proper break-in of your new vehicle drivetrain components the following guidelines are recommended:

CAUTION!

- **Avoid towing a trailer for the first 500 miles (805 km) of vehicle operation. Doing so may damage your vehicle.**
- **During the first 500 miles (805 km) of trailer towing, limit your speed to 50 mph (80 km/h).**

Perform the maintenance listed in “Maintenance Schedule.” Refer to Section 8 of this manual. When towing a trailer, never exceed the GAWR, or GCWR, ratings.

WARNING!

Improper towing can lead to an injury accident. Follow these guidelines to make your trailer towing as safe as possible:

Make certain that the load is secured in the trailer and will not shift during travel. When trailering cargo that is not fully secured, dynamic load shifts can occur that may be difficult for the driver to control. You could lose control of your vehicle and have an accident.

- When hauling cargo or towing a trailer, do not overload your vehicle or trailer. Overloading can cause a loss of control, poor performance or damage to brakes, axle, engine, transmission, steering, suspension, chassis structure or tires.
- Safety chains must always be used between your vehicle and trailer. Always connect the chains to the hook retainers of the vehicle hitch. Cross the chains under the trailer tongue and allow enough slack for turning corners.
- Vehicles with trailers should not be parked on a grade. When parking, apply the parking brake on the tow vehicle. Put the tow vehicle transmission in P (Park). For four-wheel-drive vehicles, make sure the transfer case is not in N (Neutral). Always, block or "chock" the trailer wheels.
- GCWR must not be exceeded.
- **Total weight must be distributed between the tow vehicle and the trailer such that the following four ratings are not exceeded:**
 1. GVWR
 2. GTW

3. GAWR

4. Tongue weight rating for the trailer hitch utilized (This requirement may limit the ability to always achieve the 10% to 15% range of tongue weight as a percentage of total trailer weight).

Towing Requirements — Tires

- Do not attempt to tow a trailer while using a compact spare tire.
- Proper tire inflation pressures are essential to the safe and satisfactory operation of your vehicle. Refer to the “Tires–General Information” section for proper tire inflation procedures.
- Also, check the trailer tires for proper tire inflation pressures before trailer usage.

- Check for signs of tire wear or visible tire damage before towing a trailer. Refer to the “Tires–General Information” section of this manual for the proper inspection procedure.
- When replacing tires, refer to the “Tires–General Information” section of this manual for proper tire replacement procedures. Replacing tires with a higher load carrying capacity will not increase the vehicle’s GVWR and GAWR limits.

Towing Requirements — Trailer Brakes

- Do **not** interconnect the hydraulic brake system or vacuum system of your vehicle with that of the trailer. This could cause inadequate braking and possible personal injury.
- An electronically actuated trailer brake controller is required when towing a trailer with electronically

actuated brakes. When towing a trailer equipped with a hydraulic surge actuated brake system, an electronic brake controller is not required.

- Trailer brakes are recommended for trailers over 1,000 lbs (454 kg) and required for trailers in excess of 2,000 lbs (907 kg).

CAUTION!

If the trailer weighs more than 1,000 lbs (454 kg) loaded, it should have its own brakes and they should be of adequate capacity. Failure to do this could lead to accelerated brake lining wear, higher brake pedal effort, and longer stopping distances.

WARNING!

Do not connect trailer brakes to your vehicle's hydraulic brake lines. It can overload your brake system and cause it to fail. You might not have brakes when you need them and could have an accident.

Towing any trailer will increase your stopping distance. When towing you should allow for additional space between your vehicle and the vehicle in front of you. Failure to do so could result in an accident.

Towing Requirements — Trailer Lights & Wiring

Whenever you pull a trailer, regardless of the trailer size, stop lights and turn signals on the trailer are required for motoring safety.

The Trailer Tow Package may include a 4 and 7 pin wiring harness. Use a factory approved trailer harness and connector.

The electrical connections are all complete to the vehicle but you must mate the harness to a trailer connector. Refer to the following illustrations.

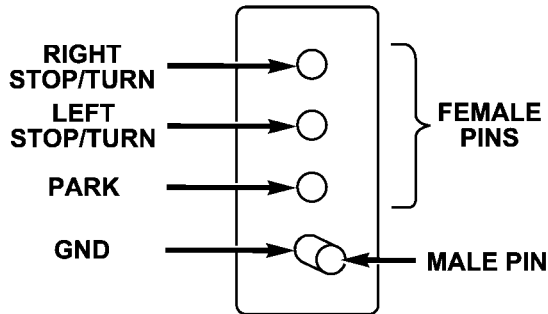

813262be

4 - Pin Connector

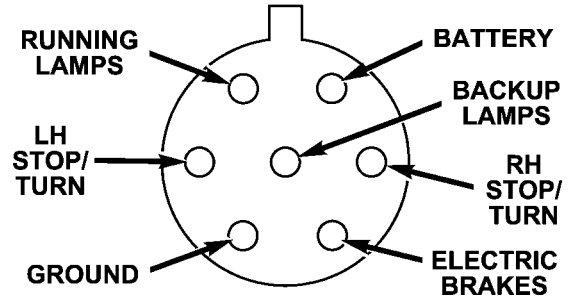

812634c6

7- Pin Connector

Towing Tips

Before setting out on a trip, practice turning, stopping and backing the trailer in an area away from heavy traffic.

Towing Tips — Automatic Transmission

The “D” range can be selected when towing. However, if frequent shifting occurs while in this range, the “Tow/Haul” mode (if equipped) or a lower gear range should be selected.

NOTE: Using the “Tow/Haul” mode (if equipped) or a lower gear range while operating the vehicle under heavy operating conditions will improve performance and extend transmission life by reducing excessive shifting and heat build up. This action will also provide better engine braking.

The automatic transmission fluid and filter should be changed if you REGULARLY tow a trailer for more than 45 minutes of continuous operation. Refer to the “Maintenance Schedule” in Section 8 of this manual for transmission fluid change intervals.

NOTE: Check the automatic transmission fluid level before towing.

Towing Tips — Electronic Speed Control (If Equipped)

- Don’t use in hilly terrain or with heavy loads.
- When using the speed control, if you experience speed drops greater than 10 mph (16 km/h), disengage until you can get back to cruising speed.
- Use speed control in flat terrain and with light loads to maximize fuel efficiency.

Towing Tips — Cooling System

To reduce potential for engine and transmission overheating, take the following actions:

– City Driving

When stopped for short periods of time, put transmission in N (Neutral) and increase engine idle speed.

– Highway Driving

Reduce speed.

– **Air Conditioning**

Turn off temporarily.

- refer to Cooling System Operating information in the Maintenance section of this manual for more information.

RECREATIONAL TOWING (BEHIND MOTORHOME, ETC.)

Towing – 2WD Models

Recreational towing is allowed ONLY if the driveshaft is removed. Towing with the rear wheels on the ground while the driveshaft is connected can result in severe transmission damage.

Towing — Quadra-Trac I (Single-Speed Transfer Case) 4WD Models

Recreational towing is not allowed. This model does not have a N (Neutral) position in the transfer case.

Towing — Quadra-Trac II /Quadra-Drive II 4WD Models

CAUTION!

Front or rear wheel lifts should not be used. Internal damage to the transmission or transfer case will occur if a front or rear wheel lift is used when recreational towing.

NOTE: The transfer case must be in the N (Neutral) position, and the transmission must be in the P (Park) position for recreational towing.

Shifting Into Neutral (N)

Use the following procedure to prepare your vehicle for recreational towing.

CAUTION!

It is necessary to follow these steps to be certain that the transfer case is fully in N (Neutral) before recreational towing to prevent damage to internal parts.

1. Depress brake pedal.
2. Turn the ignition key ON, engine off.
3. Shift transmission into N (Neutral).
4. Shift transfer case into N (Neutral).

Hold down N (Neutral) “pin” switch (with a pen, etc.) for 4 seconds until the LED lamp by the switch starts to blink indicating shift in progress. Lamp will stop blinking (stay

on solid) when Neutral shift is complete. A “4WD SYSTEM IN NEUTRAL” message will display on the EVIC (Electronic Vehicle Information Center). Refer to “Electronic Vehicle Information Center (EVIC)” in Section 4 of this manual.

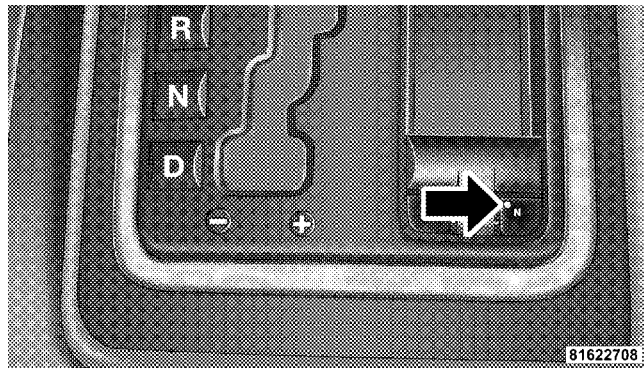

Neutral Switch

5. Start engine.
6. Shift transmission into D (Drive).
7. Release brake pedal and ensure that there is no vehicle movement.
8. Shut the engine off.
9. Shift transmission into P (Park).
10. Place the ignition key in the OFF position, and remove key.
11. Apply parking brake.
12. Attach vehicle to the tow vehicle with tow bar.
13. Release parking brake.

CAUTION!

Transmission damage may occur if the transmission is shifted into P (Park) with the transfer case in N (Neutral) and the engine running. With the transfer case in N (Neutral) ensure that the engine is OFF prior to shifting the transmission into P (Park) (refer to steps 7 – 8 above).

5**Shifting Out Of Neutral (N)**

Use the following procedure to prepare your vehicle for normal usage.

1. Depress brake pedal.
2. Turn the ignition key ON, engine off.
3. Shift transmission into N (Neutral).
4. Shift transfer case out of N (Neutral).

Hold down N (Neutral) “pin” switch (with a pen, etc.) for 4 seconds until the LED lamp by the switch starts to blink indicating shift in progress. Lamp will stop blinking (go out) when shift is complete. The “4WD SYSTEM IN NEUTRAL” message will no longer be displayed on the EVIC (Electronic Vehicle Information Center). Refer to “Electronic Vehicle Information Center (EVIC)” in Section 4 of this manual.

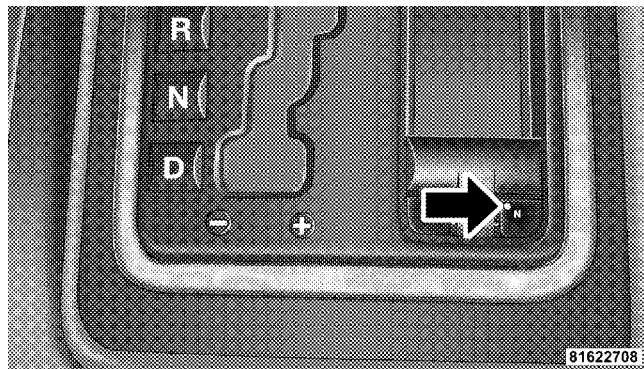

Neutral Switch

5. Shift transmission into P (Park).
6. Start the engine.
7. Shift transmission into D (Drive).

NOTE: When shifting out of transfer case N (Neutral), turning the engine OFF may be required to avoid gear clash.

WARNING!

You or others could be injured if you leave the vehicle unattended with the transfer case in the N (Neutral) position without first fully engaging the parking brake. The transfer case N (Neutral) position disengages both the front and rear driveshafts from the powertrain and will allow the vehicle to move regardless of the transmission position. The parking brake should always be applied when the driver is not in the vehicle.

CAUTION!

Do not use a bumper mounted clamp-on tow bar on your vehicle. The bumper face bar will be damaged.

SNOW PLOW

Snow plows, winches, and other aftermarket equipment should **not** be added to the front end of your vehicle. The airbag crash sensors may be affected by the change in the front end structure. The airbags could deploy unexpectedly or could fail to deploy during a collision.

WARNING!

Do not add a snow plow, winches, or any other aftermarket equipment to the front of your vehicle. This could adversely affect the functioning of the airbag system and you could be injured.

WHAT TO DO IN EMERGENCIES

CONTENTS

■ Hazard Warning Flashers	366	□ Jacking Instructions	371
■ If Your Engine Overheats	367	■ Jump Starting	374
■ Jacking And Tire Changing	368	■ Emergency Tow Hooks — If Equipped	377
□ Jack Location	368	■ Towing A Disabled Vehicle	378
□ Spare Tire Stowage	369	□ 2WD Models Only	378
□ Spare Tire Removal	369	□ 4WD Models Only	378
□ Preparations For Jacking	370		

HAZARD WARNING FLASHERS

Your vehicle's hazard warning flasher is an emergency warning system. When you activate it, all front and rear directional signals will flash intermittently. Use it when your vehicle is disabled on or near the road. It warns other drivers to steer clear of you and your vehicle. This is an emergency warning system, not to be used when the vehicle is in motion.

To activate the warning flashers, press the button on the upper switch bank. To turn the warning flashers off, press the button again.

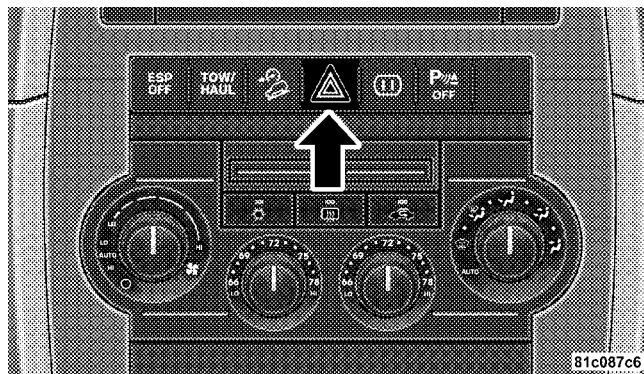

Hazard Warning Switch

NOTE: With extended use, the flasher may run down your battery.

IF YOUR ENGINE OVERHEATS

In any of the following situations, you can reduce the potential for overheating by taking the appropriate action.

- On the highways — Slow down.
- In city traffic — While stopped, put transmission in N (Neutral), but do not increase engine idle speed.

NOTE: There are steps that you can take to slow down an impending overheat condition. If your air conditioner is on, turn it off. The air conditioning system adds heat to the engine cooling system and turning off the A/C removes this heat. You can also turn the Temperature Control to maximum heat, the Mode Control to floor, and the Fan Control to High. This allows the heater core to act as a supplement to the radiator and aids in removing heat from the engine cooling system.

CAUTION!

Driving with a hot cooling system could damage your vehicle. If the temperature gauge reads “H”, pull over and stop the vehicle. Idle the vehicle with the air conditioner turned off until the pointer drops back into the normal range. If the pointer remains on the “H”, and you hear continuous chimes, turn the engine off immediately, and call for service.

JACKING AND TIRE CHANGING

WARNING!

- **Getting under a jacked-up vehicle is dangerous. The vehicle could slip off the jack and fall on you. You could be crushed. Never get any part of your body under a vehicle that is on a jack. If you need to get under a raised vehicle, take it to a service center where it can be raised on a lift.**
- **The jack is designed to use as a tool for changing tires only. The jack should not be used to lift the vehicle for service purposes. The vehicle should be jacked on a firm level surface only. Avoid ice or slippery areas.**

Jack Location

The scissor-type jack and tire changing tools are located in a compartment behind the third row seat. Refer to “Cargo Area Features” in Section 3 of this manual.

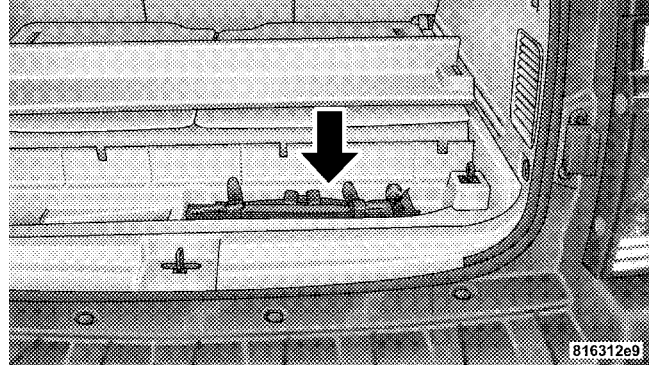

Jack Storage Location

Spare Tire Stowage

The spare tire is stowed under the rear of the vehicle by means of a cable winch mechanism. To remove or stow the spare, use the jack handle to rotate the “spare tire drive” nut. The nut is located under a plastic cover at the center-rear of the cargo floor area, just inside the liftgate opening.

CAUTION!

Do not use power tools to winch the tire up or down. Impact type tools can damage the winch mechanism.

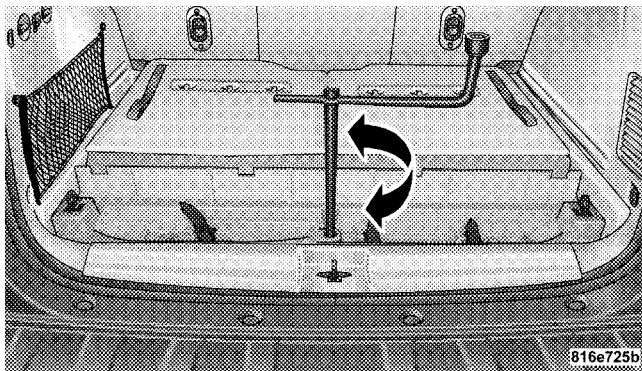

Lowering/Raising Spare Tire

Spare Tire Removal

Fit the jack handle extension over the drive nut. Use the Lug Wrench to rotate the nut counter clockwise until the spare is on the ground with enough slack in the cable to allow to pull the tire out from under the vehicle.

CAUTION!

The winch mechanism is designed for use with the jack extension tube only. Use of an air wrench or other power tools is not recommended and can damage the winch.

When the spare is clear, tilt the retainer at the end of the cable and pull it through the center of the wheel.

Preparations For Jacking

Park the vehicle on a firm level surface, avoid ice or slippery areas, **set the parking brake** and place the gear selector in P (Park). Turn OFF the ignition.

WARNING!

Do not attempt to change a tire on the side of the vehicle close to moving traffic. Pull far enough off the road to avoid being hit when operating the jack or changing the wheel.

- Turn on the Hazard Warning Flasher.

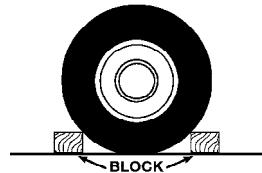

- Block both the front and rear of the wheel diagonally opposite of the jacking position. For example, if changing the right front tire, block the left rear wheel.
- Passengers should not remain in the vehicle when the vehicle is being jacked.

Jacking Instructions

1. Remove the spare tire, jack, and tools from storage.
2. Loosen (but do not remove) the wheel lug nuts by turning them to the left one turn while the wheel is still on the ground.
3. Assemble the jack and jacking tools as shown. Connect jack handle driver (A) to two extensions (B), then to the lug wrench (C).

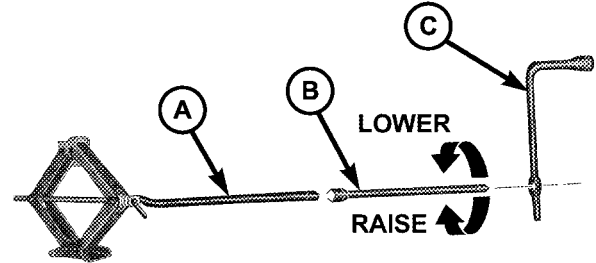

8107e507

6

4. Locate the jack as shown. For the front axle, place it under the front lower control arm as shown. For the rear axle, place it under the axle near the wheel to be changed. Ensure the jack is closest to the inside of the wheel when jacking on the rear axle. **Do not raise the vehicle until you are sure the jack is fully engaged.**

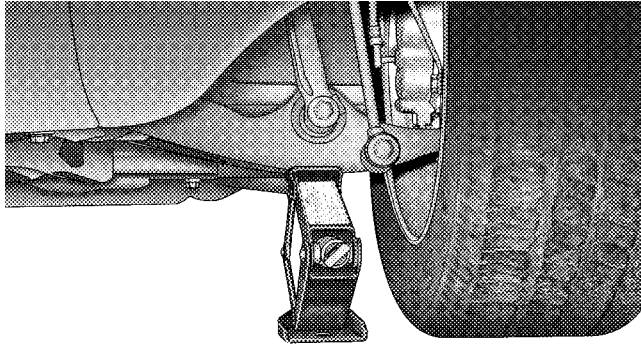

8141842b

Front Jacking Location

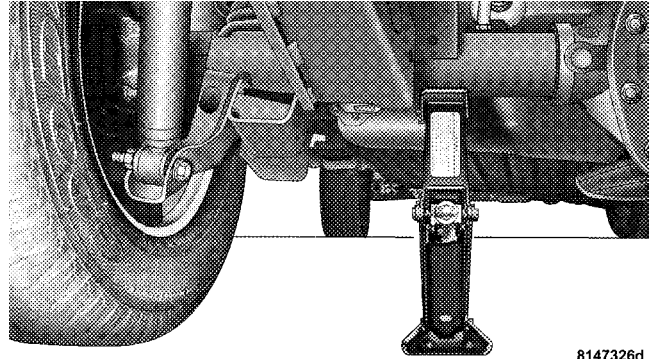

8147326d

Rear Jacking Location

5. Raise the vehicle by turning the jack screw clockwise. Raise the vehicle only until the tire just clears the surface and enough clearance is obtained to install the spare tire. Minimum tire lift provides maximum stability.

WARNING!

Raising the vehicle higher than necessary can make the vehicle less stable. It could slip off the jack and hurt someone near it. Raise the vehicle only enough to remove the tire.

6. Remove the lug nuts and wheel.
7. Position the spare wheel/tire on the vehicle and install the lug nuts with the cone-shaped end toward the wheel. Lightly tighten the nuts. To avoid the risk of forcing the vehicle off the jack, do not tighten the nuts fully until the vehicle has been lowered.
8. Lower the vehicle by turning the jack screw counter clockwise, and remove the jack and wheel blocks.

9. Finish tightening the lug nuts. Push down on the wrench while tightening for increased leverage. Alternate nuts until each nut has been tightened twice. Correct wheel nut tightness is 130 N·m (95 ft. lbs). If in doubt about the correct tightness, have them checked with a torque wrench by your authorized dealer or at a service station.

10. Lower the jack to it's fully closed position.

WARNING!

A loose tire or jack, thrown forward in a collision or hard stop could endanger the occupants of the vehicle. Always stow the jack parts and the spare tire in the places provided.

11. Secure the tire, jack, and tools in their proper locations.

NOTE: Tire should be stowed with the “beauty” side up. Storing the tire upside down may result in scratching or damage to the wheel face. Continue winching up the tire until you hear the winch “ratchet” three times. Double check to ensure the tire is snug against the underbody of the vehicle. Damage to the winch cable may result if the vehicle is driven with the tire loose.

WARNING!

**Do not use power tools to winch the tire up or down.
Impact type tools may damage the winch mechanism.**

12. Reinstall the rubber plug into the floor of the cargo area.

JUMP STARTING

If the vehicle has a discharged battery, booster cables may be used to obtain a start from a booster battery or the battery in another vehicle. This type of start can be dangerous if done improperly, so follow this procedure carefully.

WARNING!

Battery fluid is a corrosive acid solution; do not allow battery fluid to contact eyes, skin or clothing. Don't lean over battery when attaching clamps or allow the clamps to touch each other. If acid splashes in eyes or on skin, flush contaminated area immediately with large quantities of water.

A battery generates hydrogen gas which is flammable and explosive. Keep flame or spark away from the vent holes.

Do not use a booster battery or any other booster source that has a greater than 12 volt system, i.e. Do not use a 24 volt power source.

1. Remove all metal jewelry such as watch bands or bracelets which might make an unintended electrical contact.

2. Park the booster vehicle within cable reach but without letting the vehicles touch. Set the parking brake on both vehicles, place the transmission in P (Park), and turn the ignition OFF.

3. Turn off the heater, radio, and all unnecessary electrical loads.

4. Connect one end of a jumper cable to the positive terminal of the booster battery. Connect the other end of the same cable to the positive terminal of the discharged battery.

WARNING!

Do not permit vehicles to touch each other as this could establish a ground connection and personal injury could result.

5. Connect the other cable, first to the negative terminal of the booster battery and then to the engine of the vehicle with the discharged battery. Make sure you have a good contact on the engine.
6. Start the engine in the vehicle which has the booster battery, let the engine idle a few minutes, then start the engine in the vehicle with the discharged battery.
7. When removing the jumper cables, reverse the above sequence exactly. Be careful of the moving belts and fan.

WARNING!

Any procedure other than above could result in:

- 1. Personal injury caused by electrolyte squirting out the battery vent;**
- 2. Personal injury or property damage due to battery explosion;**
- 3. Damage to charging system of booster vehicle or of immobilized vehicle.**

WARNING!

- **You should not try to start your vehicle by pushing or towing.**
- **Do not connect the cable to the negative post of the discharge battery. The resulting electrical spark could cause the battery to explode.**
- **During cold weather when temperatures are below freezing point, electrolyte in a discharged battery may freeze. Do not attempt jump starting because the battery could rupture or explode. The battery temperature must be brought up above freezing point before attempting jump start.**

EMERGENCY TOW HOOKS — IF EQUIPPED

If your vehicle is equipped with tow hooks, there will be one in the rear and two mounted on the front of the vehicle. The rear hook will be located on the driver's side of the vehicle.

NOTE: For off-road recovery, it is recommended to use both of the front tow hooks to minimize the risk of damage to the vehicle.

CAUTION!

Tow hooks are for emergency use only, to rescue a vehicle stranded off road. Do not use tow hooks for tow truck hookup or highway towing. You could damage your vehicle.

WARNING!

Stand clear of vehicles when pulling with tow hooks. Tow straps and chains may break, causing serious injury.

TOWING A DISABLED VEHICLE**2WD Models Only**

Provided the transmission is operable, tow only in N (Neutral) at speeds not exceeding 30 mph (48 km/h), for distances of not more than 15 miles (24 km). Towing at more than 30 mph (48 km/h) or for more than 15 miles

(24 km) can cause severe transmission damage. If the transmission is not operable, or the vehicle must be towed faster than 30 mph (48 km/h) or farther than 15 miles (24 km), remove the driveshaft or tow with all four wheels **OFF** the ground. Acceptable methods are to tow the vehicle on a flatbed or with one end of the vehicle raised and the other end on a towing dolly.

4WD Models Only

The manufacturer recommends towing with all four wheels **OFF** the ground. Acceptable methods are to tow the vehicle on a flatbed or with one end of the vehicle raised and the other end on a towing dolly.

MAINTAINING YOUR VEHICLE

CONTENTS

■ Engine Compartment – 3.7L	382	■ Maintenance Procedures	389
■ Engine Compartment – 4.7L	383	□ Engine Oil	389
■ Engine Compartment – 5.7L	384	□ Drive Belts — Check Condition And Tension . .	392
■ Onboard Diagnostic System — OBD II	385	□ Spark Plugs	392
□ Loose Fuel Filler Cap Message	386	□ Spark Plug Wires	392
■ Emissions Inspection And Maintenance Programs	386	□ Engine Air Cleaner Filter	393
■ Replacement Parts	388	□ Catalytic Converter	393
■ Dealer Service	388	□ Crankcase Emission Control System	395
		□ Maintenance-Free Battery	395

- Air Conditioner Maintenance397
- Power Steering Fluid Check398
- Body Lubrication399
- Windshield Wiper Blades400
- Windshield Washers — Front And Rear400
- Exhaust System401
- Cooling System401
- Hoses And Vacuum/Vapor Harnesses406
- Fuel System Connections407
- Brake System407
- Front/Rear Axle Fluid410
- Transfer Case410
- Automatic Transmission411
- Maintenance After Off-Road Driving414
- Appearance Care And Protection From Corrosion415
- Fuse Panel419
 - Interior Fuses419
 - Underhood Fuses (Power Distribution Center)422
 - Underhood Fuses (Integrated Power Module)425
- Vehicle Storage426
- Replacement Bulbs427
 - Bulb Replacement428
 - Head Light428
 - Front Turn Signal430

□ Front Fog Light	431	■ Fluids, Lubricants, And Genuine Parts	436
□ Rear Tail, Stop, Turn Signal, And Back-Up Lights	432	□ Engine	436
□ Center High Mounted Stop Light (CHMSL) . . .	434	□ Chassis	437
■ Fluids And Capacities	435		

ENGINE COMPARTMENT – 3.7L

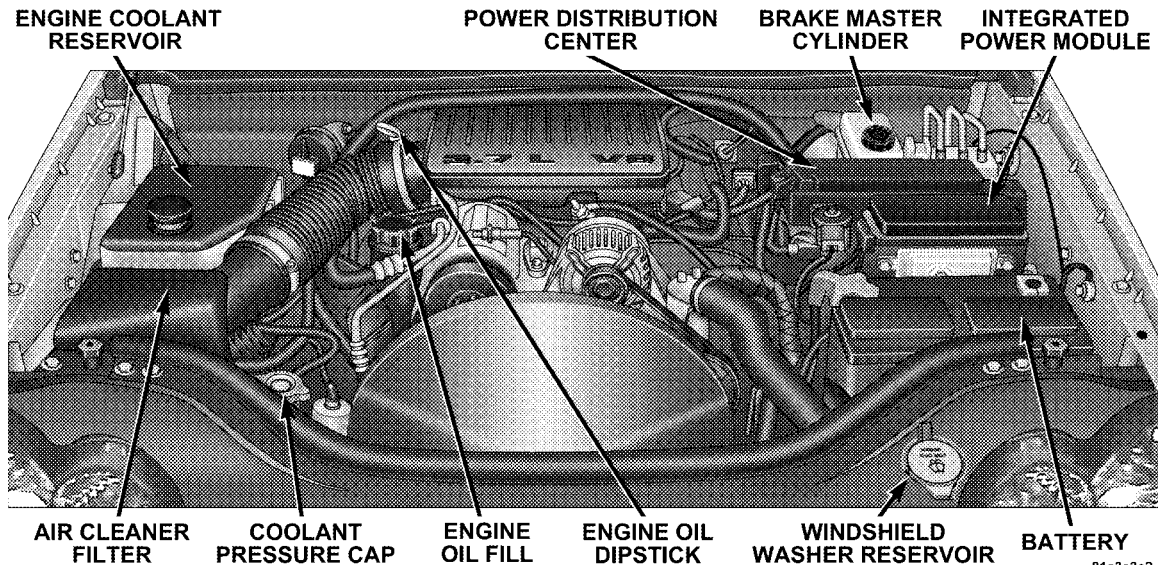

81c3e3e2

ENGINE COMPARTMENT – 4.7L

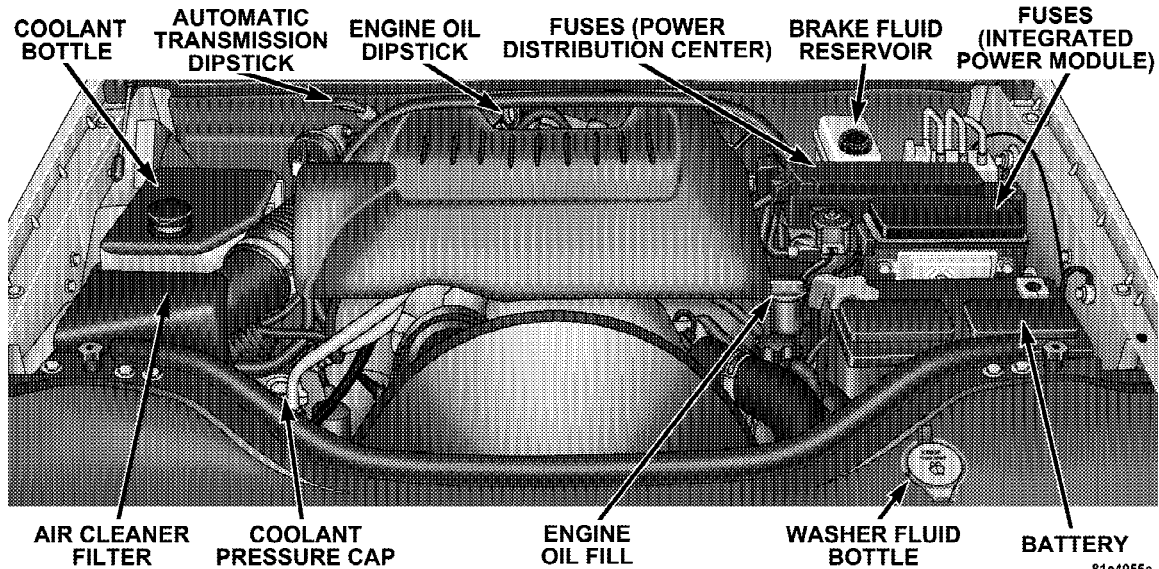

81c4955e

ENGINE COMPARTMENT – 5.7L

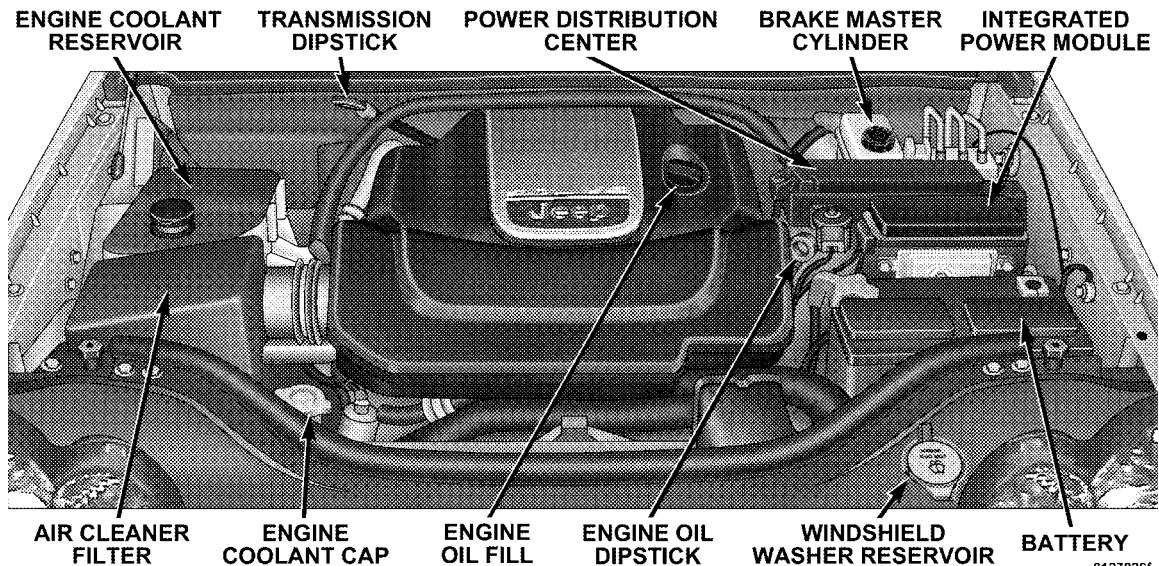

8127826f

ONBOARD DIAGNOSTIC SYSTEM — OBD II

Your vehicle is equipped with a sophisticated onboard diagnostic system called OBD II. This system monitors the performance of the emissions, engine, and automatic transmission control systems. When these systems are operating properly, your vehicle will provide excellent performance and fuel economy, as well as engine emissions well within current government regulations.

If any of these systems require service, the OBD II system will turn on the “Malfunction Indicator Light.” It will also store diagnostic codes and other information to assist your service technician in making repairs. Although your vehicle will usually be drivable and not need towing, see your dealer for service as soon as possible.

CAUTION!

- **Prolonged driving with the “Malfunction Indicator Light” on could cause further damage to the emission control system. It could also affect fuel economy and driveability. The vehicle must be serviced before any emissions tests can be performed.**
- **If the “Malfunction Indicator Light” is flashing while the engine is running, severe catalytic converter damage and power loss will soon occur. Immediate service is required.**

Loose Fuel Filler Cap Message

After fuel is added, the vehicle diagnostic system can determine if the fuel filler cap is loose, improperly installed, or damaged. A “CHECK GASCAP” message will be displayed in the EVIC (Refer to Section 4 of this manual). Tighten the gas cap until a “clicking” sound is heard. This is an indication that the gas cap is properly tightened.

This message may be temporarily overridden by pressing either the C/T, STEP, or MENU buttons. However, after one minute of no customer interaction, the EVIC will display again the “CHECK GASCAP” message. The message will remain displayed until the vehicle diagnostic system can retest the fuel system. The test will perform the next time the vehicle is started, if the vehicle was keyed off above 40°F (4°C) outside temperature and the following vehicle start is above 40°F (4°C) outside temperature. It may be possible to have a message that will not clear due to the test being disabled due to low

outside temperatures. If the test is performed and the problem is gone, the message will disappear.

If the problem persists, the message will appear the next time the vehicle is started. This might indicate a damaged cap. If the problem is detected twice in a row, the system will turn on the Malfunction Indicator Light (MIL). Resolving the problem will turn the MIL light off. See your authorized dealer for service.

EMISSIONS INSPECTION AND MAINTENANCE PROGRAMS

In some localities, it may be a legal requirement to pass an inspection of your vehicle’s emissions control system. Failure to pass could prevent vehicle registration.



For states which have an I/M (Inspection and Maintenance) requirement, this check verifies the following: the MIL (Malfunction Indicator Lamp)

is functioning and is not on when the engine is running, and that the OBD (On Board Diagnostic) system is ready for testing.

Normally, the OBD system will be ready. The OBD system may **not** be ready if your vehicle was recently serviced, if you recently had a dead battery, or a battery replacement. If the OBD system should be determined not ready for the I/M test, your vehicle may fail the test.

Your vehicle has a simple ignition key actuated test which you can use prior to going to the test station. To check if your vehicle's OBD system is ready, you must do the following:

1. Insert your ignition key into the ignition switch.
2. Turn the ignition to the ON position, but do not crank or start the engine.
3. If you crank or start the engine, you will have to start this test over.

4. As soon as you turn your key to the ON position, you will see your MIL symbol come on as part of a normal bulb check.

5. Approximately 15 seconds later, one of two things will happen:

- a. The MIL will flash for about 10 seconds and then return to being fully illuminated until you turn off the ignition key or start the engine. This means that your vehicle's OBD system is **not ready** and you should **not** proceed to the I/M station.
- b. The MIL will not flash at all and will remain fully illuminated until you turn off the ignition key or start the engine. This means that your vehicle's OBD system is **ready** and you can proceed to the I/M station.

If your OBD system is **not ready**, you should see your authorized dealer or repair facility. If your vehicle was recently serviced or had a battery failure or replacement,

you may need to do nothing more than drive your vehicle as you normally would in order for your OBD system to update. A recheck with the above test routine may then indicate that the system is now ready.

Regardless of whether your vehicle's OBD system is ready or not ready, if the MIL symbol is illuminated during normal vehicle operation, you should have your vehicle serviced before going to the I/M station. The I/M station can fail your vehicle because the MIL symbol is on with the engine running.

REPLACEMENT PARTS

Use of genuine Mopar® parts for normal/scheduled maintenance and repairs is highly recommended to insure the designed performance. Damage or failures caused by the use of non-Mopar® parts for maintenance and repairs will not be covered by the manufacturer's warranty.

DEALER SERVICE

Your dealer has the qualified service personnel, special tools and equipment to perform all service operations in an expert manner. Service Manuals are available which include detailed service information for your vehicle. Refer to these manuals before attempting any procedure yourself.

NOTE: Intentional tampering with emissions control systems can result in civil penalties being assessed against you.

WARNING!

You can be badly injured working on or around a motor vehicle. Do only that service work for which you have the knowledge and the proper equipment. If you have any doubt about your ability to perform a service job, take your vehicle to a competent mechanic.

MAINTENANCE PROCEDURES

The pages that follow contain the **required** maintenance services determined by the engineers who designed your vehicle.

Besides the maintenance items for which there are fixed maintenance intervals, there are other items that should operate satisfactorily without periodic maintenance. However, if a malfunction of these items does occur, it could adversely affect the engine or vehicle performance.

These items should be inspected if a malfunction is observed or suspected.

Engine Oil**Checking Oil Level**

To assure proper engine lubrication, the engine oil must be maintained at the correct level. Check the oil level at regular intervals, such as every fuel stop. The best time to check the engine oil level is about 5 minutes after a fully warmed engine is shut off or before starting the engine after it has sat overnight.

Checking the oil while the vehicle is on level ground will improve the accuracy of the oil level readings. Maintain the oil level in the SAFE level range. Adding 1 U.S. Quart (0.95L) of oil when the level is at the bottom of the SAFE range will result in the level being at the top of the SAFE range.

CAUTION!

Overfilling or underfilling the crankcase will cause aeration or loss of oil pressure. This could damage your engine.

Change Engine Oil

Refer to the Maintenance Schedule for recommended engine oil change intervals.

Engine Oil Selection

For best performance and maximum protection for all engines under all types of operating conditions, the manufacturer only recommends engine oils that are API Certified and meet the requirements of DaimlerChrysler Material Standard MS-6395.

American Petroleum Institute (API) Engine Oil Identification Symbol

This symbol means that the oil has been certified by the American Petroleum Institute (API). The manufacturer only recommends API Certified engine oils.

Engine Oil Viscosity (3.7L/4.7L/5.7L Engines)

SAE 5W-20 engine oil is recommended for all operating temperatures. This engine oil improves low temperature starting and vehicle fuel economy. The engine oil filler cap also shows the recommended engine oil viscosity for your vehicle. For information on engine oil filler cap location, refer to the "Engine Compartment" illustration in this section.

NOTE: Vehicles equipped with a 5.7L engine must use SAE 5W-20 oil. Failure to do so may result in improper operation of the Multiple Displacement System (MDS). Refer to “Multi Displacement System” in Section 5 for more details.

Lubricants which do not have both, the engine oil certification mark and the correct SAE viscosity grade number should not be used.

Synthetic Engine Oils

You may use synthetic engine oils provided the recommended oil quality requirements are met, and the recommended maintenance intervals for oil and filter changes are followed.

Materials Added to Engine Oils

The manufacturer **strongly recommends** against the addition of any additives (other than leak detection dyes) to

engine oil. Engine oil is an engineered product and its performance may be impaired by supplemental additives.

Disposing of Used Engine Oil and Oil Filters

Care should be taken in disposing of the used engine oil and oil filters from your vehicle. Used oil and oil filters, indiscriminately discarded, can present a problem to the environment. Contact your local authorized dealer, service station, or governmental agency for advice on how and where used oil and oil filters can be safely discarded in your area.

Engine Oil Filter

The engine oil filter should be replaced with a new filter at every oil change.

Engine Oil Filter Selection

All of the manufacturer's engines have a full-flow type disposable oil filter. Use a filter of this type for replacement. The quality of replacement filters varies considerably. Only high quality filters should be used to assure most efficient service. Mopar® engine oil filters are high quality oil filters and are recommended.

Drive Belts — Check Condition and Tension

Belt tension is controlled by means of an automatic tensioner. No belt tension adjustments are required. However, belt and belt tensioner condition should be inspected at the specified intervals, and replaced if required. See your authorized dealer for service.

At the mileage indicated in the Maintenance Schedule, all belts and tensioner should be checked for condition. Improper belt tension can cause belt slippage and failure.

Belts should be inspected for evidence of cuts, cracks, glazing, or frayed cords and replaced if there is indication

of damage which could result in belt failure. Low generator belt tension can cause battery failure.

Also, check belt routing to make sure there is no interference between the belts and other engine components.

Spark Plugs

Spark plugs must fire properly to assure engine performance and emission control. New spark plugs should be installed at the specified mileage. The entire set should be replaced if there is any malfunction due to a faulty spark plug. Refer to "Fluids, Lubricants, and Genuine Parts" in this section for spark plug information.

Spark Plug Wires

The spark plug wires should be kept clean and properly connected. Terminals should be fully seated. Cracked, damaged, or faulty wires should be replaced.

Engine Air Cleaner Filter

Refer to the Maintenance Schedule for recommended Engine Air Cleaner Filter change intervals.

WARNING!

The air induction system (air cleaner, hoses, etc) can provide a measure of protection in the case of engine backfire. Do not remove the air induction system (air cleaner, hoses, etc) unless such removal is necessary for repair or maintenance. Make sure that no one is near the engine compartment before starting the vehicle with the air induction system (air cleaner, hoses, etc) removed. Failure to do so can result in serious personal injury.

Catalytic Converter

The catalytic converter requires the use of unleaded fuel only. Leaded gasoline will destroy the effectiveness of the converter as an emission control device.

Under normal operating conditions, the catalytic converter will not require maintenance. However, it is important to keep the engine properly tuned to assure proper catalyst operation and prevent possible catalyst damage.

CAUTION!

Damage to the catalytic converter can result if your vehicle is not kept in proper operating condition. In the event of engine malfunction, particularly involving engine misfire or other apparent loss of performance, have your vehicle serviced promptly. Continued operation of your vehicle with a severe malfunction could cause the converter to overheat, resulting in possible damage to the converter and vehicle.

NOTE: Intentional tampering with emissions control systems can result in civil penalties being assessed against you.

WARNING!

A hot exhaust system can start a fire if you park over materials that can burn. Such materials might be grass or leaves coming into contact with your exhaust system. Do not park or operate your vehicle in areas where your exhaust system can contact anything that can burn.

In unusual situations involving grossly malfunctioning engine operation, a scorching odor may suggest severe and abnormal catalyst overheating. If this occurs, stop the vehicle, turn off the engine and allow it to cool. Service, including a tune up to manufacturer's specifications, should be obtained immediately.

To minimize the possibility of catalytic converter damage:

- Do not shut off the engine or interrupt the ignition when the transmission is in gear and the vehicle is in motion.
- Do not try to start the engine by pushing or towing the vehicle.
- Do not idle the engine with any spark plug wires disconnected or removed, such as when diagnostic testing, or for prolonged periods during very rough idle or malfunctioning operating conditions.

Crankcase Emission Control System

Proper operation of this system depends on freedom from sticking or plugging due to deposits. As vehicle mileage builds up, the PCV valve and passages may accumulate deposits. If a valve is not working properly, replace it with a new valve. **DO NOT ATTEMPT TO CLEAN THE OLD PCV VALVE!**

Check ventilation hose for indication of damage or plugging deposits. Replace if necessary.

Maintenance-Free Battery

Your vehicle is equipped with a maintenance-free battery. You will never have to add water, nor is periodic maintenance required.

WARNING!

- Battery fluid is a corrosive acid solution and can burn or even blind you. Don't allow battery fluid to contact your eyes, skin or clothing. Don't lean over a battery when attaching clamps. If acid splashes in eyes or on skin, flush the area immediately with large amounts of water.
- Battery gas is flammable and explosive. Keep flame or sparks away from the battery. Don't use a booster battery or any other booster source with an output greater than 12 volts. Don't allow cable clamps to touch each other.
- Battery posts, terminals, and related accessories contain lead and lead compounds. Always wash hands after handling the battery.

CAUTION!

- It is essential when replacing the cables on the battery that the positive cable is attached to the positive post and the negative cable is attached to the negative post. Battery posts are marked (+) positive and negative (-) and identified on the battery case.
- If a "fast charger" is used while battery is in the vehicle, disconnect both vehicle battery cables before connecting the charger to battery. Do not use a "fast charger" to provide starting voltage.

Air Conditioner Maintenance

For best possible performance, your air conditioner should be checked and serviced by an Authorized Dealer at the start of each warm season. This service should include cleaning of the condenser fins and a performance test. Drive belt condition should also be checked at this time.

WARNING!

- **Use only refrigerants and compressor lubricants approved by the manufacturer for your air conditioning system. Some unapproved refrigerants are flammable and can explode, injuring you. Other unapproved refrigerants or lubricants can cause the system to fail, requiring costly repairs. Refer to Section 3 of the Warranty Information Book for additional warranty information.**
- **The air conditioning system contains refrigerant under high pressure. To avoid risk of personal injury or damage to the system, adding refrigerant or any repair requiring lines to be disconnected should be done by an experienced repairman.**

NOTE: Use only manufacturer approved A/C System Sealers, Stop Leak Products, Seal Conditioners, Compressor Oil, and Refrigerants.

Refrigerant Recovery and Recycling

R-134a Air Conditioning Refrigerant is a hydrofluorocarbon (HFC) that is endorsed by the Environmental Protection Agency and is an ozone-saving product. However, the manufacturer recommends that air conditioning service be performed by dealers or other service facilities using recovery and recycling equipment.

Power Steering Fluid Check

The power steering system requires the use of Mopar® Hydraulic System Power Steering Fluid (P/N 05142893AA), or equivalent, which meets DaimlerChrysler Material Standard MS-10838.

CAUTION!

Do not use Automatic Transmission Fluid (ATF) or other types of power steering fluids when servicing the power steering system of this vehicle. Damage to the power steering system can result from the use of the wrong power steering fluid.

Checking the power steering fluid level at a defined service interval is not required. The fluid should only be checked if a leak is suspected, abnormal noises are apparent, and/or the system is not functioning as anticipated. Coordinate inspection efforts through a certified “DaimlerChrysler Dealership.”

WARNING!

Fluid level should be checked on a level surface with the engine off to prevent injury from moving parts, and to insure accurate fluid level reading. Do not overfill. Use only the manufacturer's recommended fluid.

If necessary, add fluid to restore to the proper indicated level. With a clean cloth, wipe any spilled fluid from all surfaces. Refer to Fluids, Lubricants, and Genuine Parts for correct fluid type.

NOTE: Upon initial start-up in cold weather, the power steering pump may make noise for a short period of time. This is due to the cold, thick fluid in the steering system. This noise should be considered normal, and does not in any way damage the steering system.

Body Lubrication

Locks and all body pivot points, including such items as seat tracks, doors, tailgate and hood hinges, should be lubricated periodically to assure quiet, easy operation and to protect against rust and wear. Prior to the application of any lubricant, the parts concerned should be wiped clean to remove dust and grit; after lubricating excess oil and grease should be removed. Particular attention should also be given to hood latching components to insure proper function. When performing other underhood services, the hood latch, release mechanism and safety catch should be cleaned and lubricated.

The external lock cylinders should be lubricated twice a year, preferably in the fall and spring. Apply a small amount of a high quality lubricant such as Mopar® Lock Cylinder Lubricant directly into the lock cylinder.

Windshield Wiper Blades

The rubber edges of the wiper blades and the windshield should be cleaned periodically with a sponge or soft cloth and a mild nonabrasive cleaner to remove accumulations of salt or road film.

Operation of the wipers on dry glass for long periods may cause deterioration of the wiper blades. Always use washer fluid when using the wipers to remove salt or dirt from a dry windshield.

Avoid using the wiper blades to wipe frost or ice from the windshield. Keep the blade rubber out of contact with petroleum products such as engine oil, gasoline, etc.

Windshield Washers — Front and Rear

On vehicles equipped with a Electronic Vehicle Information Center (EVIC), the low washer fluid level will be indicated. When the sensor detects a low fluid level, the windshield will light on the vehicle graphic outline and the “Washer Fluid Low” message will be displayed.

The fluid reservoir for the windshield washers and the rear window washer is shared. The fluid reservoir is located in the engine compartment, be sure to check the fluid level at regular intervals. Fill the reservoir with windshield washer solvent only (not radiator antifreeze). When refilling the washer fluid reservoir, take some washer fluid and apply it to a cloth or towel and wipe clean the wiper blades, this will help blade performance. To prevent freeze-up of your windshield washer system in cold weather, select a solution or mixture that meets or exceeds the temperature range of your climate. This rating information can be found on most washer fluid containers.

WARNING!

Commercially available windshield washer solvents are flammable. They could ignite and burn you. Care must be exercised when filling or working around the washer solution.

Exhaust System

The best protection against carbon monoxide entry into the vehicle body is a properly maintained engine exhaust system.

If you notice a change in the sound of the exhaust system; or if the exhaust fumes can be detected inside the vehicle; or when the underside or rear of the vehicle is damaged; have an authorized technician inspect the complete exhaust system and adjacent body areas for broken, damaged, deteriorated, or mispositioned parts. Open seams or loose connections could permit exhaust fumes to seep

into the passenger compartment. In addition, inspect the exhaust system each time the vehicle is raised for lubrication or oil change. Replace as required.

Cooling System**WARNING!**

You or others can be badly burned by hot antifreeze/coolant or steam from your radiator. If you see or hear steam coming from under the hood, don't open the hood until the radiator has had time to cool. Never try to open a cooling system pressure cap when the radiator or coolant bottle is hot.

7

Engine Coolant Checks

Check antifreeze/coolant protection every 12 months (before the onset of freezing weather, where applicable). If antifreeze/coolant is dirty or rusty in appearance, the

system should be drained, flushed and refilled with fresh antifreeze/coolant. Check the front of the A/C condenser for any accumulation of bugs, leaves, etc. If dirty, clean by gently spraying water from a garden hose vertically down the face of the condenser.

Check the engine cooling system hoses for brittle rubber, cracking, tears, cuts, and tightness of the connection at the coolant recovery bottle and radiator. Inspect the entire system for leaks.

With the engine at normal operating temperature (but not running), check the cooling system pressure cap for proper vacuum sealing by draining a small amount of coolant from the radiator drain cock. If the cap is sealing properly, the antifreeze/coolant will begin to drain from the coolant recovery bottle. **DO NOT REMOVE THE COOLANT PRESSURE CAP WHEN THE COOLING SYSTEM IS HOT.**

Cooling System — Drain, Flush, And Refill

At the intervals shown on the Maintenance Schedule, the system should be drained, flushed and refilled.

If the solution is dirty and contains a considerable amount of sediment, clean and flush with reliable cooling system cleaner. Follow with a thorough rinsing to remove all deposits and chemicals. Properly dispose of old antifreeze/coolant solution.

Selection Of Coolant

Use only the manufacturer's recommended antifreeze/coolant, refer to Fluids, Lubricants, and Genuine Parts for correct antifreeze/coolant type.

CAUTION!

Mixing of antifreeze/coolant other than the specified HOAT antifreeze/coolant may result in decreased corrosion protection and engine damage. If a non-HOAT antifreeze/coolant is introduced into the cooling system in an emergency, it should be replaced with the specified antifreeze/coolant as soon as possible.

Do not use plain water alone or alcohol base antifreeze/coolant products. Do not use additional rust inhibitors or antirust products, as they may not be compatible with the antifreeze/coolant and may plug the radiator.

This vehicle has not been designed for use with Propylene Glycol based antifreeze/coolant. Use of Propylene Glycol base antifreeze/coolant is not recommended.

Adding Coolant

Your vehicle has been built with an improved antifreeze/coolant that allows extended maintenance intervals. This antifreeze/coolant can be used up to 5 Years or 100,000 miles (160 000 km) before replacement. To prevent reducing this extended maintenance period, it is important that you use the same antifreeze/coolant throughout the life of your vehicle. Please review these recommendations for using Hybrid Organic Additive Technology (HOAT) antifreeze/coolant.

When adding antifreeze/coolant:

- The manufacturer recommends using Mopar® Antifreeze/ Coolant 5 Year/100,000 Mile Formula HOAT (Hybrid Organic Additive Technology)
- • Mix a minimum solution of 50% HOAT engine coolant and distilled water. Use higher concentrations (not to exceed 70%) if temperatures below -34°F (-37°C) are anticipated.

- Use only high purity water such as distilled or deionized water when mixing the water/antifreeze (coolant) solution. The use of lower quality water will reduce the amount of corrosion protection in the engine cooling system.

Please note that it is the owner's responsibility to maintain the proper level of protection against freezing according to the temperatures occurring in the area where the vehicle is operated.

NOTE: Mixing antifreeze/coolant types will decrease the life of the antifreeze/coolant and will require more frequent antifreeze/coolant changes.

Cooling System Pressure Cap

The cap must be fully tightened to prevent loss of antifreeze/coolant, and to insure that antifreeze/coolant will return to the radiator from the coolant recovery tank.

The cap should be inspected and cleaned if there is any accumulation of foreign material on the sealing surfaces.

WARNING!

- The warning words **DO NOT OPEN HOT** on the cooling system pressure cap are a safety precaution. Never add antifreeze/coolant when the engine is overheated. Do not loosen or remove the cap to cool an overheated engine. Heat causes pressure to build up in the cooling system. To prevent scalding or injury, do not remove the pressure cap while the system is hot or under pressure.
- Do not use a pressure cap other than the one specified for your vehicle. Personal injury or engine damage may result.

Disposal of Used Engine Coolant

Used ethylene glycol-based antifreeze/coolant is a regulated substance requiring proper disposal. Check with your local authorities to determine the disposal rules for your community. To prevent ingestion by animals and children, do not store ethylene glycol-based antifreeze/coolant in open containers or allow it to remain in puddles on the ground. If ingested by a child, contact a physician immediately. Clean up any ground spills immediately.

Coolant Level

The coolant bottle provides a quick visual method for determining that the antifreeze/coolant level is adequate. With the engine idling, and warm to normal operating temperature, the level of the antifreeze/coolant in the bottle should be between the ranges indicated on the bottle.

The radiator normally remains completely full, so there is not need to remove the radiator cap unless checking for antifreeze/coolant freeze point or replacing antifreeze/coolant. Advise your service attendant of this. As long as the engine operating temperature is satisfactory, the coolant bottle need only be checked once a month.

When additional antifreeze/coolant is needed to maintain the proper level, it should be added to the coolant bottle. Do not overfill.

Points To Remember

NOTE: When the vehicle is stopped after a few miles (kilometers) of operation, you may observe vapor coming from the front of the engine compartment. This is normally a result of moisture from rain, snow, or high humidity accumulating on the radiator and being vaporized when the thermostat opens, allowing hot antifreeze/coolant to enter the radiator.

If an examination of your engine compartment shows no evidence of radiator or hose leaks, the vehicle may be safely driven. The vapor will soon dissipate.

- Do not overfill the coolant recovery bottle.
- Check antifreeze/coolant freeze point in the radiator and in the coolant recovery bottle. If antifreeze/coolant needs to be added, contents of coolant recovery bottle must also be protected against freezing.
- If frequent antifreeze/coolant additions are required, or if the level in the coolant recovery bottle does not drop when the engine cools, the cooling system should be pressure tested for leaks.
- Maintain antifreeze/coolant concentration at 50% HOAT antifreeze/coolant (minimum) and distilled water for proper corrosion protection of your engine which contains aluminum components.

- Make sure that the radiator and coolant recovery bottle hoses are not kinked or obstructed.
- Keep the front of the radiator clean. If your vehicle is equipped with air conditioning, keep the front of the condenser clean, also.
- Do not change the thermostat for summer or winter operation. If replacement is ever necessary, install ONLY the correct type thermostat. Other designs may result in unsatisfactory cooling performance, poor gas mileage, and increased emissions.

Hoses and Vacuum/Vapor Harnesses

Inspect surfaces of hoses and nylon tubing for evidence of heat and mechanical damage. Hard or soft spots, brittle rubber, cracking, tears, cuts, abrasions, and excessive swelling indicate deterioration of the rubber.

Pay particular attention to the hoses nearest to high heat sources such as the exhaust manifold. Inspect hose routing to be sure hoses do not touch any heat source or moving component that may cause heat damage or mechanical wear.

Insure nylon tubing in these areas has not melted or collapsed. Inspect all hose connections such as clamps and couplings to make sure they are secure and no leaks are present. Components should be replaced immediately if there is any evidence of degradation that could cause failure.

Fuel System Connections

Electronic Fuel Injection high pressure fuel systems are designed with tubes and special connects, connections and clamps which have unique material characteristics to provide adequate sealing and resist attack by deteriorated gasoline.

You are urged to use only the manufactures-specified tubes, connections and clamps, or their equivalent in material and specification, in any fuel system servicing.

Brake System

In order to assure brake system performance, all brake system components should be inspected periodically. Refer to the Maintenance Schedule in Section 8 for suggested service intervals.

WARNING!

Riding the brakes can lead to brake failure and possibly an accident. Driving with your foot resting or riding on the brake pedal can result in abnormally high brake temperatures, excessive lining wear, and possible brake damage. You wouldn't have your full braking capacity in an emergency.

Brake and Power Steering System Hoses

When servicing the vehicle for scheduled maintenance, inspect surface of hoses for evidence of heat and mechanical damage. Hard and brittle rubber, cracking, tears, cuts, abrasion, and excessive swelling suggest deterioration of the rubber. Particular attention should be made to examining those hose surfaces nearest to high heat sources, such as the exhaust manifold.

Inspect all hose clamps and couplings to make sure they are secure and no leaks are present.

NOTE: Often fluids such as oil, power steering fluid, and brake fluid are used during assembly plant operations to ease the assembly of hoses to couplings. Therefore, oil wetness at the hose-coupling area is not necessarily an indication of leakage. Actual dripping of hot fluid when systems are under pressure (during vehicle operation) should be noted before hose is replaced based on leakage.

NOTE: Inspection of brake hoses should be done whenever the brake system is serviced and every engine oil change.

WARNING!

Worn brake hoses can burst and cause brake failure. You could have an accident. If you see any signs of cracking, scuffing, or worn spots, have the brake hoses replaced immediately.

Brake Master Cylinder — Brake Fluid Level Check
The fluid level in the master cylinder should be checked when performing under hood services, or immediately if the brake system warning lamp shows system failure

Be sure to clean the top of the master cylinder area before removing the cap. If necessary, add fluid to bring the fluid level up to the requirements described on the brake

fluid reservoir. With disc brakes, fluid level can be expected to fall as the brake pads wear. However, low fluid level may be caused by a leak and a checkup may be needed.

Use only manufacturer's recommended brake fluid, refer to Fluids, Lubricants, and Genuine Parts for correct fluid type.

WARNING!

Use of a brake fluid that may have a lower initial boiling point or unidentified as to specification, may result in sudden brake failure during hard prolonged braking. You could have an accident.

WARNING!

Overfilling the brake fluid reservoir can result in spilling brake fluid on hot engine parts and the brake fluid catching fire.

Use only brake fluid that has been in a tightly closed container to avoid contamination from foreign matter or moisture.

CAUTION!

Do not allow petroleum base fluid to contaminate the brake fluid as seal damage will result.

Front/Rear Axle Fluid

Front Axle Fluid Level Check

Lubricant should be to the bottom of the oil fill hole.

Rear Axle Fluid Level Check

Lubricant should be 1/2" (1 cm) below the oil fill hole.

Adding Fluid

Add lubricant only at the fill hole and only to the level specified above.

Selection of Lubricant

Use only manufacturer's recommended fluid, refer to Fluids, Lubricants, and Genuine Parts for correct fluid type.

Transfer Case

Fluid Level Check

Inspect the transfer case for fluid leaks. If a fluid leak is found, the transfer case fluid level can be checked by removing the filler plug located on the back side of the transfer case. The fluid level should be at the bottom edge of the filler plug hole when the vehicle is in a level position.

Adding Fluid

Add fluid at the filler hole until it runs out of the hole when the vehicle is in a level position.

Drain

First remove fill plug, then remove drain plug. Recommended tightening torque for drain and fill plugs is 15–25 ft. lbs (20–34 N·m).

CAUTION!

When installing plugs, do not overtighten. You could damage them and cause them to leak.

Selection of Lubricant

Use only manufacturer's recommended fluid, refer to Fluids, Lubricants, and Genuine Parts for correct fluid type.

Automatic Transmission**Selection of Lubricant**

It is important that the proper lubricant is used in the transmission to assure optimum transmission performance. Use only manufacturer's recommended transmission fluid, refer to Fluids, Lubricants, and Genuine Parts

for correct fluid type. It is important that the transmission fluid be maintained at the prescribed level using the recommended fluid.

CAUTION!

Using a transmission fluid other than the manufacturer's recommended fluid may cause deterioration in transmission shift quality and/or torque converter shudder. Using a transmission fluid other than the manufacturer's recommended fluid will result in more frequent fluid and filter changes. Refer to Fluids, Lubricants, and Genuine Parts for correct fluid type.

7

Fluid Level Check (3.7L Engine)

Regular automatic transmission fluid level checks are not required. For this reason, the dipstick is omitted.

If you notice fluid loss or gear shift malfunction, have your authorized dealer check the transmission fluid level.

CAUTION!

The fluid level is preset at the factory and it does not require adjustment under normal operating conditions. If a transmission fluid leak occurs, visit your authorized dealer immediately. Severe damage to the transmission may occur. Your authorized dealer has the proper tools to adjust the fluid level accurately.

Fluid Level Check (4.7L and 5.7L Engine)

Check the fluid level while the transmission is at normal operating temperature. This occurs after at least 15 miles (25 km) of driving. At normal operating temperature the fluid cannot be held comfortably between the fingertips.

To check the automatic transmission fluid level properly, the following procedure must be used:

1. Operate the engine at idle speed and normal operating temperature.
2. The vehicle must be on level ground.
3. Fully apply the parking brake and press the brake pedal.
4. Place the gear selector momentarily in each gear position ending with the lever in P (Park).
5. Remove the dipstick, wipe it clean and reinsert it until seated.
6. Remove the dipstick again and note the fluid level on both sides. The fluid level should be between the "HOT" (upper) reference holes on the dipstick at normal operating temperature. The fluid level is only valid if there is a solid coating of oil is seen on both sides of the dipstick. If

the fluid is low, add as required into the dipstick tube. **Do not overfill.** After adding any quantity of oil through the oil fill tube, wait a minimum of two (2) minutes for the oil to fully drain into the transmission before rechecking the fluid level.

NOTE: If it is necessary to check the transmission **below** the operating temperature, the fluid level should be between the two “COLD” (lower) holes on the dipstick with the fluid at approximately 70°F (21°C) (room temperature). If the fluid level is correctly established at room temperature, it should be between the “HOT” (upper) reference holes when the transmission reaches 180°F (82°C). Remember it is best to check the level at the normal operating temperature.

CAUTION!

Be aware that if the fluid temperature is below 50°F (10°C) it may not register on the dipstick. Do not add fluid until the temperature is elevated enough to produce an accurate reading.

7. Check for leaks. Release parking brake.

To prevent dirt and water from entering the transmission after checking or replenishing fluid, make certain that the dipstick cap is properly reseated. It is normal for the dipstick cap to spring back slightly from its fully seated position, as long as its seal remains engaged in the dipstick tube.

7

Special Additives

Automatic Transmission Fluid (ATF) is an engineered product and its performance may be impaired by supplemental additives. Therefore, do not add any fluid additives to the transmission. The only exception to this policy is the use of special dyes to aid in detecting fluid leaks. In addition, avoid using transmission sealers as they may adversely affect seals.

Maintenance After Off-Road Driving

After extended operation in mud, sand or water, or similar dirty conditions, have your brake discs, brake linings, and axle joints inspected and cleaned as soon as possible. This will prevent any abrasive material from causing excessive wear or unpredictable braking action.

After off-road driving, completely inspect the underbody of your vehicle. Check tires, body structure, steering, suspension and exhaust system for damage. Check threaded fasteners for looseness, particularly on the chassis, drivetrain components, steering and suspension. Retighten, if required, to torque values specified in the Service Manual. Also check for accumulations of vegetation or brush that could become a fire hazard, or conceal damage to fuel lines, brake hoses, axle pinion seals, and propeller shafts.

CAUTION!

Under frequent heavy-duty driving conditions, change all lubricants and lubricate body components, all driveline joints and steering linkage more often than in normal service to prevent excessive wear.

Appearance Care And Protection From Corrosion

Protection of Body and Paint from Corrosion

Vehicle body care requirements vary according to geographic locations and usage. Chemicals that make roads passable in snow and ice, and those that are sprayed on trees and road surfaces during other seasons, are highly corrosive to the metal in your vehicle.

The following maintenance recommendations will enable you to obtain maximum benefit from the corrosion resistance built into your vehicle.

What Causes Corrosion?

Corrosion is the result of deterioration or removal of paint and protective coatings from your vehicle.

The most common causes are:

- Road salt, dirt and moisture accumulation.
- Stone and gravel impact.
- Insects, tree sap and tar.

- Salt in the air near seacoast localities.
- Atmospheric fallout/industrial pollutants.

Washing

- Wash your vehicle regularly. Always wash your vehicle in the shade using Mopar® Car Wash or a mild car wash soap, and rinse the panels completely with clear water.
- If insects, tar, or other similar deposits have accumulated on your vehicle, use Mopar® Super Kleen Bug and Tar Remover to remove.
- Use Mopar® Cleaner Wax to remove road film, stains, and to protect your paint finish. Take care never to scratch the paint.
- Avoid using abrasive compounds and power buffing that may diminish the gloss or thin out the paint finish.

CAUTION!

- **Do not use abrasive or strong cleaning materials such as steel wool or scouring powder, which will scratch metal and painted surfaces.**
- **Use of power washers exceeding 1,200 psi (8 274 kPa) can result in damage or removal of paint and decals.**

Special Care

- If you drive on salted or dusty roads or if you drive near the ocean, hose off the undercarriage at least once a month.
 - It is important that the drain holes in the lower edges of the doors, rocker panels and tailgate must be kept clear and open.
- If you detect any stone chips or scratches in the paint, touch them up immediately. The cost of such repairs is considered the responsibility of the owner.
 - If your vehicle is damaged due to an accident or similar cause which destroys the paint and protective coating have your vehicle repaired as soon as possible. The cost of such repairs is considered the responsibility of the owner.
 - If you carry special cargo such as chemicals, fertilizers, de-icer salt, etc., assure that such materials are well packaged and sealed.
 - If a lot of driving is done on gravel roads, consider mud or stone shields behind each wheel.
 - Use Mopar® Touch Up Paint on scratches or chips as soon as possible. Your authorized dealer has touch up paint to match the color of your vehicle.

Wheel and Wheel Trim Care

All wheels and wheel trim, especially aluminum and chrome plated wheels should be cleaned regularly with a mild soap and water to prevent corrosion. To remove heavy soil, use Mopar® Wheel Cleaner or select a non-abrasive, non-acidic cleaner. Do not use scouring pads, steel wool, a bristle brush or metal polishes. Only Mopar® cleaners are recommended. Do not use oven cleaner. Avoid automatic car washes that use acidic solutions or harsh brushes that may damage the wheels' protective finish.

Interior Care

Use Mopar® Total Clean to clean fabric upholstery and carpeting.

Interior Trim should be cleaned starting with a damp cloth, a damp cloth with Mopar® Total Clean, then

Mopar® Spot & Stain Remover if absolutely necessary. Do not use harsh cleaners or Armorall. Use Mopar® Total Clean to clean vinyl upholstery.

Leather Seat Care & Cleaning

Mopar® Total Clean is specifically recommended for leather upholstery.

Your leather upholstery can be best preserved by regular cleaning with a damp soft cloth. Small particles of dirt can act as an abrasive and damage the leather upholstery and should be removed promptly with a damp cloth. Stubborn soils can be removed easily with a soft cloth and Mopar® Total Clean. Care should be taken to avoid soaking your leather upholstery with any liquid. Please do not use polishes, oils, cleaning fluids, solvents, detergents, or ammonia based cleaners to clean your leather upholstery. Application of a leather conditioner is not required to maintain the original condition.

WARNING!

Do not use volatile solvents for cleaning purposes. Many are potentially flammable, and if used in closed areas they may cause respiratory harm.

Cleaning Headlights

Your vehicle has plastic headlights that are lighter and less susceptible to stone breakage than glass headlights.

Plastic is not as scratch resistant as glass and therefore different lens cleaning procedures must be followed.

To minimize the possibility of scratching the lenses and reducing light output, avoid wiping with a dry cloth. To remove road dirt, wash with a mild soap solution followed by rinsing.

Do not use abrasive cleaning components, solvents, steel wool or other aggressive material to clean the lenses.

Glass Surfaces

All glass surfaces should be cleaned on a regular basis with Mopar® Glass Cleaner or any commercial household-type glass cleaner. Never use an abrasive type cleaner. Use caution when cleaning inside rear windows equipped with electric defrosters. Do not use scrapers or other sharp instruments which may scratch the elements.

When cleaning the rear view mirror, spray cleaner on the towel or rag that you are using. Do not spray cleaner directly on the mirror.

Cleaning Plastic Instrument Cluster Lenses

The lenses in front of the instruments in this vehicle are molded in clear plastic. When cleaning the lenses, care must be taken to avoid scratching the plastic.

1. Clean with a wet soft rag. A mild soap solution may be used, but do not use high alcohol content or abrasive cleaners. If soap is used, wipe clean with a clean damp rag.

2. Dry with a soft tissue.

Seat Belt Maintenance

Do not bleach, dye or clean the belts with chemical solvents or abrasive cleaners. This will weaken the fabric. Sun damage will also weaken the fabric.

If the belts need cleaning, use Mopar® Total Clean, a mild soap solution, or lukewarm water. Do not remove the belts from the vehicle to wash them.

Replace the belts if they appear frayed or worn or if the buckles do not work properly.

Dry with a soft tissue.

FUSE PANEL

Interior Fuses

The fuse panel is on the lower instrument panel just to the left of the steering column.

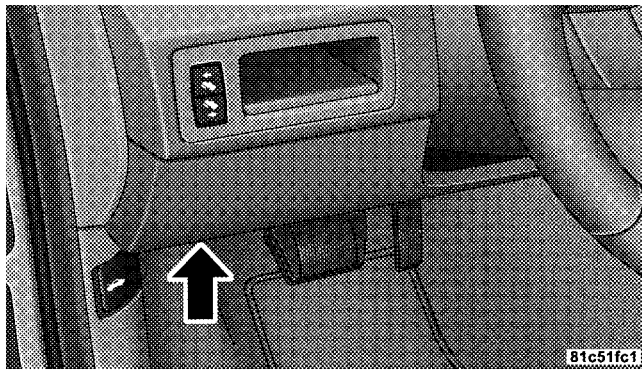

Fuse Panel

Cavity	Cartridge Fuse	Mini Fuse	Description
1		30 Amp Green	Audio Amp (B+)
2		15 Amp Blue	Sunroof (B+)
3		10 Amp Red	Htd Mirror (EBL)
4		20 Amp Yellow	Rr Pwr Out (B+)
5		10 Amp Red	Rr HVAC (R/O) (Commander Only)
6		Spare (B+)	
7		20 Amp Yellow	Door Locks (B+)
8		15 Amp Blue	Steer Col Lock (B+) (ELV)

Cavity	Cartridge Fuse	Mini Fuse	Description
9		20 Amp Yellow	Pwr Outlet (B+)
10		10 Amp Red	Final Drive Control Module (FDCM), Heater Ventilation, Air Conditioning (HVAC), Switch Bank, Transfer Case Switch, O/H, Heater Ventilation, Air Conditioning (HVAC) Relay, Rear Park As- sist
11		Spare (B+)	
12		10 Amp Red	Door Mods, Mem. Sw, O/H Lamps, IP Cour- tesy Lamps, Glove Box Lamp (B+)

Cavity	Cartridge Fuse	Mini Fuse	Description
13		10 Amp Red	Autowipe (R/A)
14		20 Amp Yellow	Cigar Ltr (R/A)
15		10 Amp Red	Tire Pressure Transducers (R/O)
16		10 Amp Red	Steering Control Module (SCM), Diag. Connector, Cluster (B+)
17		15 Amp Blue	Flipper Glass (B+)
19		Spare (R/S)	
20		10 Amp Red	Sentry Key Remote Entry Module (SKREEM), Cluster (R/S)

Cavity	Cartridge Fuse	Mini Fuse	Description
21		Spare (Acc Delay)	
22		15 Amp Blue	Rear Wiper (B+)
24		10 Amp Red	Power Distribution Center (PDC) Relays, Final Drive Control Module (FDCM), Front Control Module (FCM) (R/S), A580 (R/S)
25		10 Amp Red	Shifter Assy (BTSl), Trans. Case Switch, ESP/ABS, Brake Supply Coil (R/S)

Underhood Fuses (Power Distribution Center)

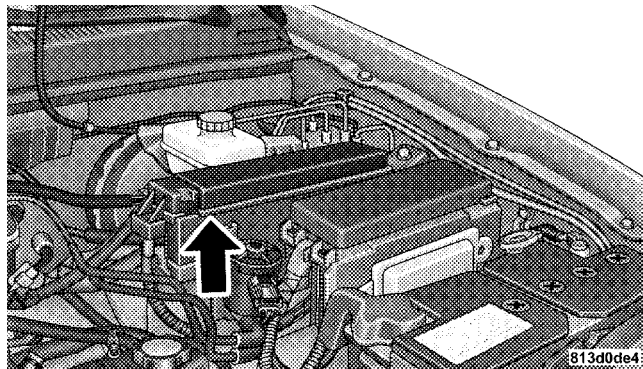

Power Distribution Center

Cavity	Cartridge Fuse	Mini Fuse	Description
1	50 Amp Green		PTC Heater 1 (Diesel Only)

Cavity	Cartridge Fuse	Mini Fuse	Description
2	40 Amp Green		HID Headlamps
3	50 Amp Green		PTC Heater 2 (Diesel Only)
4	30 Amp Pink		Power Outlets
5	50 Amp Red		PTC Heater 3 (Diesel Only)
6	30 Amp Pink		Cig Lighter, Trail Tow Batt
7	40 Amp Green		Power Liftgate (Commander Only)
8	40 Amp Green		Starter, JB Power
9	—		Spare
10	—		Spare

Cavity	Cartridge Fuse	Mini Fuse	Description
11	40 Amp Green		HVAC Blower
12	30 Amp Pink		Rear Wiper, Ign R/O
13	40 Amp Green		Rear Window Defroster (EBL)/Heated Mirror
14	30 Amp Pink		Rear HVAC (If Equipped)
15	—		Spare
16	50 Amp Red		ASD
17	30 Amp Pink		ABS Pump
18	40 Amp Green		Accessory Delay, Seats

Cavity	Cartridge Fuse	Mini Fuse	Description
19	40 Amp Green		JB Power
20	—		Spare
21		20 Amp Yellow	Fuel Pump
22		20 Amp Yellow	TCM, A/C Clutch
23		25 Amp Natural	Power Inverter
24		20 Amp Yellow	Rear Heated Seats
25		20 Amp Yellow	Final Drive Control Module (FDCM)
26		15 Amp Blue	Brake Lamps

Cavity	Cartridge Fuse	Mini Fuse	Description
27		20 Amp Yellow	HD Washer (If Equipped)
28		30 Amp Green	ABS Valves
29		20 Amp Yellow	PCM Batt (Gasoline Only)
30		—	Spare
31		—	Spare
32		15 Amp Blue	Powertrain Control Module (Diesel Only)
33		20 Amp Yellow	Final Drive Control Module (FDCM) E-Diff
34		—	Spare
35		20 Amp Yellow	Trail-Tow Mod (BUX Only)

Cavity	Cartridge Fuse	Mini Fuse	Description
36		—	Spare
37		20 Amp Yellow	Ignition Switch
38		20 Amp Yellow	HID Left
39		20 Amp Yellow	HID Right
40		25 Amp Natural	Next Generation Controller (NGC), Injectors
41		—	Spare
42		—	Spare
43		25 Amp Natural	Coils, Actuators
44		—	Spare

Underhood Fuses (Integrated Power Module)

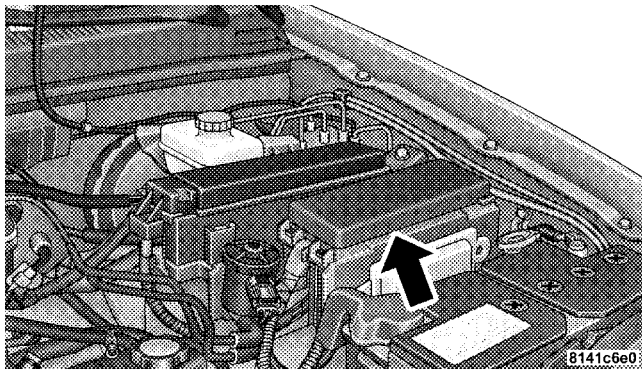

Integrated Power Module

Cavity	Cartridge Fuse	Mini Fuse	Description
8		10 Amp Red	Lt Park Lamps

Cavity	Cartridge Fuse	Mini Fuse	Description
9		10 Amp Red	Trailer-Tow Park Lamps
10		10 Amp Red	Rt Park Lamps
12		20 Amp Yellow	Front Control Module (FCM) Batt #4
13		20 Amp Yellow	Front Control Module (FCM) Batt #2
14		20 Amp Yellow	Adjustable Pedal
15		20 Amp Yellow	Ft Fog Lamps
16		20 Amp Yellow	Horn
17		20 Amp Yellow	Rear Wiper

Cavity	Cartridge Fuse	Mini Fuse	Description
18		20 Amp Yellow	Front Control Module (FCM) Batt #1
19		20 Amp Yellow	Lt Trailer-Tow Stop/Turn
20		20 Amp Yellow	Front Control Module (FCM) Batt #3
21		20 Amp Yellow	Rt Trailer-Tow Stop/Turn
22	30 Amp Pink		Final Drive Control Module (FDCM) MOD
23	50 Amp Red		Radiator Fan
27		15 Amp Blue	Ignition Off Draw (IOD) #1
28		20 Amp Yellow	Ignition Off Draw (IOD) #2

Cavity	Cartridge Fuse	Mini Fuse	Description
29		10 Amp Red	Occupant Restraint Controller (ORC) R/S
30		10 Amp Red	Occupant Restraint Controller (ORC) R/O

VEHICLE STORAGE

If you are leaving your vehicle dormant for more than 21 days you may want to take steps to protect your battery. You may:

- Remove fuse #27 in the Intelligent Power Module labeled Ignition-Off Draw (IOD#1).
- Or, disconnect the negative cable from the battery.

- Anytime you store your vehicle, or keep it out of service (i.e. vacation) for two weeks or more, run the air conditioning system at idle for about five minutes in the fresh air and high blower setting. This will insure adequate system lubrication to minimize the possibility of compressor damage when the system is started again.

REPLACEMENT BULBS

Interior Lights	Bulb Type
Glove Box Light	194
Grab Handle Light	L002825W5W
Overhead Console Reading Lights	VT4976
Rear Cargo Light	214-2
Visor Vanity Light	V26377
Underpanel Courtesy Lights	906
Instrument Cluster (General Illumination)	103
Telltale/Hazard Light	74

* Available only from authorized dealers.

Exterior Lights	Bulb Type
Backup Lights	3057K
Front Fog Lights	9145
Front Park/Turn Light	3157A
Front Side Marker	W5W
Headlights (Low Beam)	9006
Headlights (High Beam)	9005
Rear Turn/Stop/Tail Lights	3057K

NOTE: Numbers refer to commercial bulb types that can be purchased from your authorized dealer.

If a bulb needs to be replaced, visit your authorized dealer or refer to the applicable Service Manual.

BULB REPLACEMENT

Head Light

1. Open the hood.
2. Remove the headlamp cover.

Insert a finger into each hole of the headlamp cover, and pull upward to unsnap the rear edge of the cover from the two upper lamp mounting brackets. Slide the cover rearward to disengage the front edge from beneath the tab on the top near the front of the lamp housing.

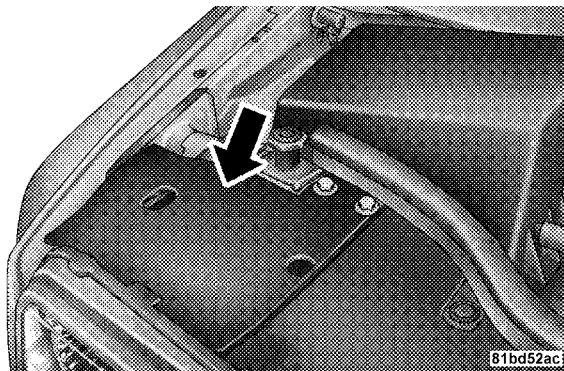

3. Disconnect the electrical connector.
4. Turn the low or high beam bulb 1/4 turn counter clockwise to unlock it from the housing.

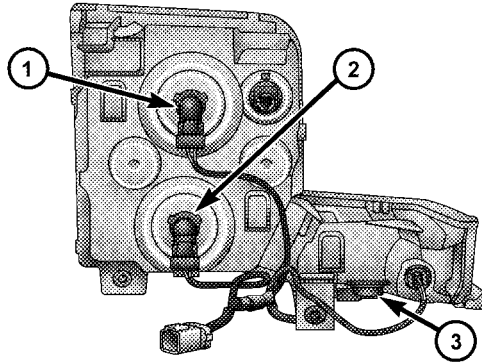

81bd52d0

- 1 — Low Beam Bulb
- 2 — High Beam Bulb
- 3 — Front Park/Turn Signal Bulb

5. Pull the bulb and base straight out from the opening in the reflector.

CAUTION!

Do not touch the new bulb with your fingers. Oil contamination will severely shorten bulb life. If the bulb comes in contact with any oily surface, clean the bulb with rubbing alcohol.

Front Turn Signal

1. Turn the steering wheel all the way to the left or right.
2. Reach into the front wheel house ahead of the front wheel to unsnap and lift the cover over the access hole in the front of the wheel house splash shield. Access to the bulb can be gained through the wheel liner hole.

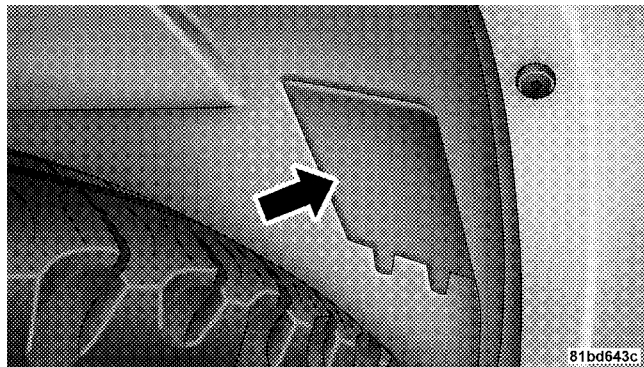

3. Reach through the access hole to access the park/turn signal bulb socket on the bottom of the front lamp unit housing.

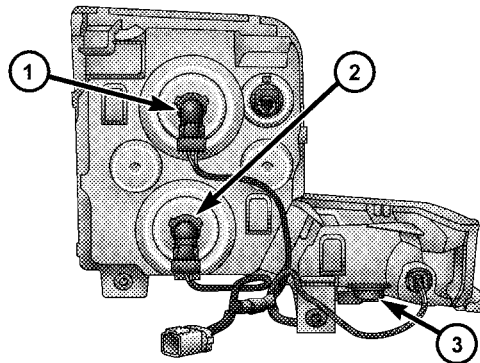

81bd52d0

- 1 — Low Beam Bulb
- 2 — High Beam Bulb
- 3 — Front Park/Turn Signal Bulb

4. Turn the socket on the bottom of the front lamp unit housing 1/4 turn counter clockwise to unlock it.
5. Pull the socket and bulb straight out from the opening in the housing.
6. Disconnect the electrical connector.
7. Pull the base of the bulb straight out of the socket.

CAUTION!

Do not touch the new bulb with your fingers. Oil contamination will severely shorten bulb life. If the bulb comes in contact with any oily surface, clean the bulb with rubbing alcohol.

Front Fog Light

1. Turn the steering wheel all the way to the left or right.
2. Reach into the front wheel house ahead of the front wheel to unsnap and lift the cover over the access hole in the front of the wheel house splash shield. Access to the bulb can be gained through the wheel liner hole.

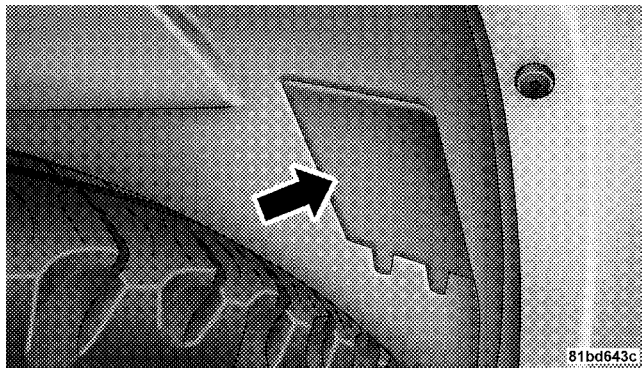

3. Reach through the access hole to access the back of the front fog light housing on the back of the front fascia.
4. Disconnect the electrical connector.
5. Turn the socket on the back of the housing 1/4 turn counter clockwise to unlock it.
6. Pull the socket and bulb straight out from the opening in the housing.
7. Pull the base of the bulb straight out of the socket.

CAUTION!

Do not touch the new bulb with your fingers. Oil contamination will severely shorten bulb life. If the bulb comes in contact with any oily surface, clean the bulb with rubbing alcohol.

Rear Tail, Stop, Turn Signal, and Back-Up Lights

1. Raise the liftgate.
2. Remove the two push-pins that secure the rear lamp unit to the side of the liftgate opening.

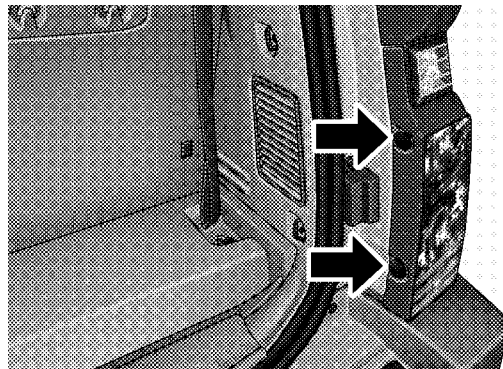

81bd6519

3. Pull the outboard side of the rear lamp unit rearward far enough to unsnap the two ball studs on the outboard side of the lamp housing from the two plastic grommets in the quarter outer panel. Pull the lamp unit rearward far enough away to access the bulbs.

4. Firmly grasp the appropriate bulb socket on the back of the rear lamp unit housing, and turn 1/4 turn counter clockwise to unlock it.

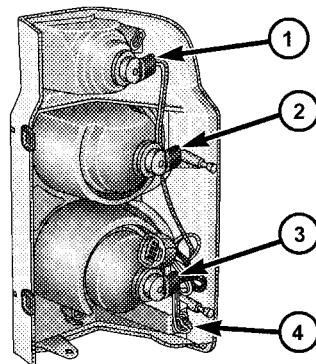

81bd6521

- 1 — Rear Backup Lamp Bulb
- 2 — Rear Park/Stop Lamp Bulb
- 3 — Rear Park/Turn Signal Bulb
- 4 — Rear Side Marker Lamp Bulb

5. Disconnect the electrical connector.
6. Pull the socket and bulb straight out from the opening in the housing.

7. Pull the base of the bulb straight out of the socket.

CAUTION!

Do not touch the new bulb with your fingers. Oil contamination will severely shorten bulb life. If the bulb comes in contact with any oily surface, clean the bulb with rubbing alcohol.

Center High Mounted Stop Light (CHMSL)

1. Remove the two screws securing the CHMSL.

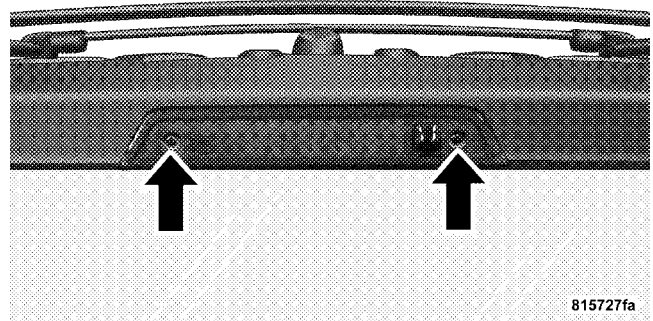

2. Twist the bulb socket to remove from the CHMSL housing.
3. Pull the bulb out of the socket.
4. Replace the bulb, reinstall the socket and reattach the CHMSL.

FLUIDS AND CAPACITIES

	U.S.	Metric
Fuel (Approximate)	21 Gallons	79 Liters
Engine Oil with Filter		
3.7 Liter Engine (SAE 5W-20, API Certified)	5 Qts	4.7 Liters
4.7 Liter Engine (SAE 5W-20, API Certified)	6 Qts	5.7 Liters
5.7 Liter Engine (SAE 5W-20, API Certified)	7 Qts	6.6 Liters
Cooling System *		
3.7 Liter Engine (Mopar® Engine Coolant/Antifreeze 5 Year/100,000 Mile Formula)	9 Qts	10 Liters
4.7 Liter Engine (Mopar® Engine Coolant/Antifreeze 5 Year/100,000 Mile Formula)	14.5 Qts	13.7 Liters
5.7 Liter Engine (Mopar® Engine Coolant/Antifreeze 5 Year/100,000 Mile Formula)	14.5 Qts	13.7 Liters

* Includes heater and coolant recovery bottle filled to MAX level.

FLUIDS, LUBRICANTS, AND GENUINE PARTS**Engine**

Component	Fluid, Lubricant, or Genuine Part
Engine Coolant	Mopar® Antifreeze/Coolant 5 Year/100,000 Mile Formula HOAT (Hybrid Organic Additive Technology)
Engine Oil (3.7L/4.7L/5.7L Engines)	Use API Certified SAE 5W-20 Engine Oil, meeting the requirements of DaimlerChrysler Material Standard MS-6395. Refer to your engine oil filler cap for correct SAE grade.
Oil Filter (All Engines)	Mopar® Oil Filter (P/N 05281090)
Spark Plugs (3.7L Engine)	ZFR6F-11G (Gap 0.043")
Spark Plugs (4.7L Engine)	Upper Bank — FR8TE2 (Gap 0.040") Lower Bank — FR8T1332 (Gap 0.050")
Spark Plugs (5.7L Engine)	REC14MCC4 (Gap 0.043")
Fuel Selection (3.7L and 4.7L Engines)	87 Octane
Fuel Selection (5.7L Engines)	87 Octane Acceptable - 89 Octane Recommended

Chassis

Component	Fluid, Lubricant, or Genuine Part
Automatic Transmission	Mopar® ATF+4 Automatic Transmission Fluid
Transfer Case (NV140 Single Speed Only)	Mopar® ATF+4 Automatic Transmission Fluid
Transfer Case (NV245 Two Speed Only)	Mopar® NV 247/245 Transfer Case Lubricant
Axle Differential (Front-Rear)	Mopar® Synthetic Gear & Axle Lubricant SAE 75W-140 (API-GL5) or equivalent with friction modifier additive.
Brake Master Cylinder	Mopar® DOT 3 Brake Fluid, SAE J1703 should be used. If DOT 3, SAE J1703 brake fluid is not available, then DOT 4 is acceptable. Use only recommended brake fluids.
Power Steering Reservoir	This system requires the use of Mopar® Hydraulic System Power Steering Fluid (P/N 05142893AA) or equivalent, which meets DaimlerChrysler Material Standard MS-10838.

MAINTENANCE SCHEDULES

CONTENTS

■ Emission Control System Maintenance	440	□ Required Maintenance Intervals	442
■ Maintenance Schedule — Gasoline Engines	440		

EMISSION CONTROL SYSTEM MAINTENANCE

The “Scheduled” maintenance services, listed in **bold type** must be done at the times or mileages specified to assure the continued proper functioning of the emission control system. These, and all other maintenance services included in this manual, should be done to provide best vehicle performance and reliability. More frequent maintenance may be needed for vehicles in severe operating conditions such as dusty areas and very short trip driving.

Inspection and service also should be done any time a malfunction is suspected.

NOTE: Maintenance, replacement, or repair of the emission control devices and systems on your vehicle may be performed by any automotive repair establishment or individual using any automotive part which has been certified pursuant to U.S. EPA or, in the State of California, California Air Resources Board regulations.

MAINTENANCE SCHEDULE — GASOLINE ENGINES

The oil change indicator system will remind you that it is time to take your vehicle in for scheduled maintenance.

On Electronic Vehicle Information Center (EVIC) equipped vehicles, “Oil Change Required” will be displayed in the EVIC and a single chime will sound, indicating that an oil change is necessary.

Based on engine operation condition the oil change indicator message will illuminate, this means that service is required for your vehicle. Have your vehicle serviced as soon as possible, within the next 500 miles (805 km).

NOTE:

- The oil change indicator message will not monitor the time since the last oil change. Change your vehicles oil if it has been 6 months since your last oil change even if the oil change indicator message is NOT illuminated.

- Change your engine oil more often if you drive your vehicle off-road for an extended period of time.
- Under no circumstances should oil change intervals exceed 6,000 miles (10,000 km) or 6 months, whichever comes first.

Your dealer will reset the oil change indicator message after completing the scheduled oil change. If this scheduled oil change is performed by someone other than your dealer the message can be reset by referring to the steps described under “Oil Change Required” in “Use Factory Settings” of the EVIC section in this manual.

At Each Stop for Fuel

- Check the engine oil level about 5 minutes after a fully warmed engine is shut off. Checking the oil level while the vehicle is on level ground will improve the accuracy of the oil level reading. Add oil only when the level is at or below the ADD or MIN mark.

- Check the windshield washer solvent and add if required.

Once a Month

- Check tire pressure and look for unusual wear or damage.
- Inspect the battery and clean and tighten the terminals as required.
- Check the fluid levels of coolant reservoir, brake master cylinder, power steering and transmission and add as needed.
- Check all lights and other electrical items for correct operation.

442 MAINTENANCE SCHEDULES

At Each Oil Change

- Change the engine oil filter.
- Inspect the brake hoses and lines.

CAUTION!

Failure to perform the required maintenance items may result in damage to the vehicle.

Required Maintenance Intervals

NOTE: ** Vehicles built with the 4.7L engine are equipped with sixteen spark plugs, one set is located on the top of the engine under the coils and the second set is located on the side of the engine.

The spark plugs located under the coils are a standard plug and must be change every 30,000 miles (50 000 km)

The spark plugs located on the side of the engine are a premium plug and must be changed every 102,000 miles (170 000 km).

Maintenance Items	Perform Maintenance Every (Where time and mileage are listed, follow the interval that occurs first.)		
	Miles	Kilometers	or Months
Change the engine oil and engine oil filter.	6,000	10 000	6
Rotate tires.	6,000	10 000	6
If using your vehicle for any of the following: Dusty or off-road conditions. Inspect the engine air cleaner filter, replace if necessary.	12,000	20 000	12
Inspect the brake linings, replace if necessary.	12,000	20 000	12
Inspect the front & rear axle fluid, change if using your vehicle for police, taxi, fleet, off-road or frequent trailer towing.	18,000	30 000	18
Inspect the CV joints. Perform the first inspection at 12,000 miles (20 000 km) or 12 months.	24,000	40 000	24
Inspect exhaust system. Perform the first inspection at 12,000 miles (20 000 km) or 12 months.	24,000	40 000	24
Inspect the front suspension, tie rod ends and boot seals, replace if necessary.	24,000	40 000	24

444 MAINTENANCE SCHEDULES

Maintenance Items	Perform Maintenance Every (Where time and mileage are listed, follow the interval that occurs first.)		
	Miles	Kilometers	or Months
Replace the engine air cleaner filter.	30,000	50 000	30
Check the PCV valve, replace if necessary. Perform the first inspection at 60,000 miles (100 000 km) or 60 months.	30,000	50 000	30
Inspect the transfer case fluid.	30,000	50 000	30
Replace the top row of spark plugs (4.7L Only). **	30,000	50 000	30
Replace the spark plugs (3.7L/5.7L Engines).	30,000	50 000	30
Change the automatic transmission fluid & filter if using your vehicle for any of the following: police, taxi, fleet or frequent trailer towing.	60,000	100 000	60
Change the transfer case fluid if using your vehicle for any of the following: police, taxi, fleet, off-road or frequent trailer towing.	60,000	100 000	60
Flush and replace the engine coolant.	102,000	170 000	60
Replace the ignition cables (4.7L Only).	102,000	170 000	102

Maintenance Items	Perform Maintenance Every (Where time and mileage are listed, follow the interval that occurs first.)		
	Miles	Kilometers	or Months
Replace the side row of spark plugs (4.7L Only). **	102,000	170 000	102
Change the automatic transmission fluid & filter.	120,000	200 000	120
Replace accessory drive belt(s) (3.7L/4.7L/5.7L Engines).	120,000	200 000	120

WARNING!

You can be badly injured working on or around a motor vehicle. Do only that service work for which you have the knowledge and the right equipment. If you have any doubt about your ability to perform a service job, take your vehicle to a competent mechanic.

IF YOU NEED CONSUMER ASSISTANCE

CONTENTS

■ Suggestions For Obtaining Service For Your Vehicle	448	■ Reporting Safety Defects	451
□ Prepare For The Appointment	448	□ In Canada	452
□ Prepare A List	448	■ Publication Order Forms	452
□ Be Reasonable With Requests	448	■ Department Of Transportation Uniform Tire Quality Grades	454
■ If You Need Assistance	448	□ Treadwear	454
■ Warranty Information (U.S. Vehicles Only)	451	□ Traction Grades	454
■ Mopar® Parts	451	□ Temperature Grades	455

SUGGESTIONS FOR OBTAINING SERVICE FOR YOUR VEHICLE

Prepare For The Appointment

If you're having warranty work done, be sure to have the right papers with you. Take your warranty folder. All work to be performed may not be covered by the warranty, discuss additional charges with the service manager. Keep a maintenance log of your vehicle's service history. This can often provide a clue to the current problem.

Prepare A List

Make a written list of your vehicle's problems or the specific work you want done. If you've had an accident, or work done that is not on your maintenance log, let the service advisor know.

Be Reasonable With Requests

If you list a number of items, and you must have your vehicle by the end of the day, discuss the situation with the service advisor and list the items in order of priority. At many dealers, you may obtain a rental vehicle at a minimal daily charge. If you need a rental, it is advisable to make these arrangements when you call for an appointment.

IF YOU NEED ASSISTANCE

The manufacturer and its dealers are vitally interested in your satisfaction. We want you to be happy with our products and services.

Warranty service must be done by an authorized Chrysler, Dodge, or Jeep dealer. We strongly recommend that you take your vehicle to your selling dealer. They know you and your vehicle best, and are most concerned that you get prompt and high quality service. The manufacturer's dealers have the facilities, factory-trained

technicians, special tools, and the latest information to assure your vehicle is fixed correctly and in a timely manner.

This is why you should always talk to your dealer's service manager first. Most matters can be resolved with this process.

- If for some reason you are still not satisfied, talk to the general manager or owner of the dealership. They want to know if you need assistance.
- If your dealership is unable to resolve the concern, you may contact the Manufacturer's Customer Center.

Any communication to the Manufacturer's Customer Center should include the following information:

- Owner's name and address
- Owner's telephone number (home and office)
- Dealership name

- Vehicle identification number
- Vehicle delivery date and mileage

DaimlerChrysler Motors Corporation Customer Center

P.O. Box 21-8004

Auburn Hills, MI 48321-8004

Phone: (800) 992-1997

DaimlerChrysler Canada Inc. Customer Center

P.O. Box 1621

Windsor, Ontario N9A 4H6

Phone: (800) 465-2001

In Mexico contact:

Av. Prolongacion Paseo de la Reforma, 1240

Sante Fe C.P. 05109

Mexico, D. F.

In Mexico (915) 729-1248 or 729-1240

Outside Mexico (525) 729-1248 or 729-1240

Customer Assistance For The Hearing Or Speech Impaired (TDD/TTY)

To assist customers who have hearing difficulties, the manufacturer has installed special TDD (Telecommunication Devices for the Deaf) equipment at its Customer Center. Any hearing or speech impaired customer who has access to a TDD or a conventional teletypewriter (TTY) in the United States can communicate with the manufacturer by dialing 1-800-380-CHRY.

Service Contract

You may have purchased a service contract for your vehicle to help protect you from the high cost of unexpected repairs after your manufacturer's new vehicle limited warranty expires. The manufacturer stands behind only the manufacturer's Service Contracts. If you purchased a manufacturer's Service Contract, you will receive Plan Provisions and an Owner Identification Card in the mail within three weeks of your vehicle delivery date. If you have any questions about your service

contract, call the manufacturer's Service Contract National Customer Hotline at 1-800-521-9922.

The manufacturer will not stand behind any service contract that is not the manufacturer's Service Contract. It is not responsible for any service contract other than the manufacturer's Service Contract. If you purchased a service contract that is not a manufacturer's Service Contract, and you require service after your manufacturer's new vehicle limited warranty expires, please refer to your contract documents, and contact the person listed in those documents.

We appreciate that you have made a major investment when you purchased your new vehicle. Your dealer has also made a major investment in facilities, tools, and training to assure that you are absolutely delighted with your ownership experience. You'll be pleased with their sincere efforts to resolve any warranty issues or related concerns.

WARNING!

Engine exhaust, some of its constituents, and certain vehicle components contain or emit chemicals known to the State of California to cause cancer and birth defects or other reproductive harm. In addition, certain fluids contained in vehicles and certain products of component wear contain or emit chemicals known to the State of California to cause cancer and birth defects or other reproductive harm.

WARRANTY INFORMATION (U.S. Vehicles Only)

See the Warranty Information Booklet for the terms and provisions of DaimlerChrysler's warranties applicable to this vehicle.

MOPAR® PARTS

Mopar® fluids, lubricants, parts, and accessories are available from your dealer. They will help you keep your vehicle operating at its best.

REPORTING SAFETY DEFECTS

In the 50 United States and Washington D.C.: If you believe that your vehicle has a defect, which could cause a crash or cause injury or death, you should immediately inform the National Highway Traffic Safety Administration (NHTSA) in addition to notifying the manufacturer.

If NHTSA receives similar complaints, it may open an investigation, and if it finds that a safety defect exists in a group of vehicles, it may order a recall and remedy campaign. However, NHTSA cannot become involved in individual problems between you, your dealer, and the manufacturer.

To contact NHTSA, you may either call the Auto Safety Hotline toll free at 1-888-327-4236 (TTY: 1-800-424-9153), or go to <http://www.safercar.gov>; or write to: Administrator, NHTSA, 400 Seventh Street, SW., Washington, DC 20590. You can also obtain other information about motor vehicle safety from <http://www.safercar.gov>.

In Canada:

If you believe that your vehicle has a safety defect, you should contact the Customer Service Department immediately. Canadian customers who wish to report a safety defect to the Canadian government should write to Transport Canada, Motor Vehicle Defect Investigations and Recalls, 2780 Sheffield Road, Ottawa, Ontario K1B 3V9.

PUBLICATION ORDER FORMS

To order the following manuals, you may use either the website or the phone numbers listed below. Visa, Mastercard, American Express, and Discover orders are accepted. If you prefer mailing your payment, please call for an order form.

NOTE: A street address is required when ordering manuals. (No P.O. Boxes).

- *Service Manuals.*

These comprehensive service manuals provide the information that students and professional technicians need in diagnosing/troubleshooting, problem solving, maintaining, servicing, and repairing DaimlerChrysler Corporation vehicles. A complete working knowledge of the vehicle, system, and/or components is written in straightforward language with illustrations, diagrams, and charts.

- *Diagnostic Procedure Manuals.*

Filled with diagrams, charts and detailed illustrations, these practical manuals make it easy for students and technicians to find and fix problems on computer-controlled vehicle systems and features. They show exactly how to find and correct problems the first time, using step-by-step troubleshooting and driveability procedures, proven diagnostic tests and a complete list of all tools and equipment.

- *Owner's Manuals.*

These manuals have been prepared with the assistance of service and engineering specialists to acquaint you with specific Chrysler group vehicles. Included are starting, operating, emergency and maintenance procedures as well as specifications, capabilities and safety tips.

Call Toll Free at:

- **1-800-890-4038 (U.S.)**
- **1-800-387-1143 (Canada)**

Or

Visit us on the World Wide Web at:

- **www.techauthority.daimlerchrysler.com**
- **www.daimlerchrysler.ca/manuals**

DEPARTMENT OF TRANSPORTATION UNIFORM TIRE QUALITY GRADES

The following describes the tire grading categories established by the National Highway Traffic Safety Administration. The specific grade rating assigned by the tire's manufacturer in each category is shown on the sidewall of the tires on your car.

All Passenger Car Tires Must Conform to Federal Safety Requirements in Addition to These Grades.

Treadwear

The treadwear grade is a comparative rating based on the wear rate of the tire when tested under controlled conditions on a specified government test course. For example, a tire graded 150 would wear one and a half (1 1/2) times as well on the government course as a tire graded 100. The relative performance of tires depends upon the actual conditions of their use, however, and

may depart significantly from the norm due to variations in driving habits, service practices and differences in road characteristics and climate.

Traction Grades

The traction grades, from highest to lowest, are AA, A, B, and C. Those grades represent the tire's ability to stop on wet pavement as measured under controlled conditions on specified government test surfaces of asphalt and concrete. A tire marked C may have poor traction performance.

WARNING!

The traction grade assigned to this tire is based on straight-ahead braking traction tests, and does not include acceleration, cornering, hydroplaning, or peak traction characteristics.

Temperature Grades

The temperature grades are A (the highest), B, and C, representing the tire's resistance to the generation of heat and its ability to dissipate heat when tested under controlled conditions on a specified indoor laboratory test wheel. Sustained high temperature can cause the material of the tire to degenerate and reduce tire life, and excessive temperature can lead to sudden tire failure. The grade C corresponds to a level of performance, which all passenger car tires must meet under the Federal Motor Vehicle Safety Standard No. 109. Grades B and A represent higher levels of performance on the laboratory test wheel than the minimum required by law.

WARNING!

The temperature grade for this tire is established for a tire that is properly inflated and not overloaded. Excessive speed, under inflation, or excessive loading, either separately or in combination, can cause heat buildup and possible tire failure.

INDEX

ABS (Anti-Lock Brake System)	188,302	Alarm System (Security Alarm)	20
Adding Fuel	341	Alignment and Balance	321
Adding Washer Fluid	177	Alterations/Modifications, Vehicle	9
Adjustable Pedals	135	Antenna, Satellite Radio	250
Air Cleaner, Engine (Engine Air Cleaner Filter)	393	Antifreeze (Engine Coolant)	435
Air Conditioner Maintenance	397	Disposal	405
Air Conditioning	259	Anti-Lock Brake System (ABS)	139,302
Air Conditioning, Operating Tips	269	Anti-Lock Warning Light	188
Air Conditioning, Rear Zone	267	Anti-Theft System	20,189
Air Conditioning Refrigerant	398	Appearance Care	415
Air Conditioning System	259	Assist, Hill Start	148
Air Filter	393	Audio Systems (Radio)	239
Air Pressure, Tires	316	Auto Down Power Windows	32
Airbag	48	Automatic Dimming Mirror	78
Airbag Deployment	55	Automatic Door Locks	29
Airbag Light	57,71,188	Automatic Headlights	126
Airbag Maintenance	57	Automatic Temperature Control (ATC)	260
Alarm, Panic	24	Automatic Transmission	283,411
Alarm (Security Alarm)	20,189	Adding Fluid	412

Fluid and Filter Changes	411	Brake System	407
Fluid Level Check	411,412	Anti-Lock (ABS)	139,302
Fluid Type	411	Hoses	408
Special Additives	414	Master Cylinder	408
Torque Converter	288	Parking	300
Autostick	285	Warning Light	187
Auxiliary Electrical Outlet (Power Outlet)	169	Brake/Transmission Interlock	283
Auxiliary Power Outlet	169	Break-In Recommendations, New Vehicle	69
Battery	395	Bulb Replacement	427,428
Emergency Starting	374	Calibration, Compass	204
Keyless Transmitter Replacement (RKE)	25	Camera, Rear	157
Saving Feature (Protection)	125	Capacities, Fluid	435
Belts, Drive	392	Caps, Filler	
Belts, Seat	39	Fuel	341
Body Mechanism Lubrication	399	Radiator (Coolant Pressure)	404
B-Pillar Location	311	Car Washes	415
Brake Assist System	141	Carbon Monoxide Warning	70,337
Brake Control System, Electronic	139	Cargo Area Features	174

Cargo Compartment	174	Compact Disc (CD) Maintenance	256
Luggage Carrier	177	Compass	203
Cargo Load Floor	174	Compass Calibration	204
Catalytic Converter	393	Compass Variance	204
CD (Compact Disc) Player	239	Computer, Trip/Travel	200
Cellular Phone	82	Connector	
Center High Mounted Stop Light	434	UCI	244
Certification Label	344	Universal Consumer Interface (UCI)	244
Chains, Tire	322	Console, Overhead	158
Changing A Flat Tire	368	Contract, Service	450
Chart, Tire Sizing	308	Converter, Catalytic	393
Checks, Safety	71,72	Cooling System	401
Child Restraint	60,61,65,67	Adding Coolant (Antifreeze)	403
Child Restraint Tether Anchors	64,65	Coolant Capacity	435
Child Safety Locks	30	Coolant Level	405
Climate Control	257	Disposal of Used Coolant	405
Clock	213,229,240,243	Drain, Flush, and Refill	402
Cold Weather Operation	278	Inspection	401,405
Command View Skylights	168	Points to Remember	405

Pressure Cap	404	Oil (Engine)	389
Radiator Cap	404	Power Steering	398
Selection of Coolant (Antifreeze)	402,435	Disabled Vehicle Towing	378
Courtesy Lights	130	Disposal	
Crankcase Emission Control System	395	Antifreeze (Engine Coolant)	405
Cruise Light	193	Engine Oil	391
Cup Holder	172	Used Engine Fluids	391
Customer Assistance	448	Door Locks	28
		Door Locks, Automatic	29
Data Recorder, Event	58	Door Opener, Garage	159
Daytime Running Lights	128	Drive Belts	392
Dealer Service	388	Driving	296
Defroster, Rear Window	177	Off-Pavement	296
Defroster, Windshield	71,258,265	Off-Road	296
Diagnostic System, Onboard	385	DVD Player (Video Entertainment System)	253
Digital Video Disc (DVD) Player	239		
Dimmer Switch, Headlight	129	E-85 Fuel	337
Dipsticks		Electric Remote Mirrors	80
Automatic Transmission	412	Electrical Outlet, Auxiliary (Power Outlet)	169

Electronic Brake Control System	139	Engine	
Anti-Lock Brake System	139	Air Cleaner	393
Brake Assist System	141	Block Heater	280
Electronic Roll Mitigation	142	Break-In Recommendations	69
Electronic Stability Program	143	Compartment	382,383,384
Traction Control System	140	Compartment Identification	382,383,384
Electronic Roll Mitigation (ERM)	142	Cooling	401
Electronic Speed Control (Cruise Control)	136	Exhaust Gas Caution	38,70,337
Electronic Stability Program (ESP)	143	Fails to Start	279
Electronic Throttle Control Warning Light	194	Fuel Requirements	333,435
Electronic Vehicle Information Center (EVIC)	192,195	Multi-Displacement	306
Emergency, In Case of		Oil	389,435
Freeing Vehicle When Stuck	289	Oil Change Interval	390
Hazard Warning Flasher	366	Oil Disposal	391
Jacking	368	Oil Filter	391
Jump Starting	374	Oil Filter Disposal	391
Tow Hooks	377	Oil Selection	435
Emission Control System Maintenance	386,440	Oil Synthetic	391
		Overheating	367

Starting	277	Turn Signal	187,430,432
Temperature Gauge	191	Flexible Fuel Vehicles	
Engine Oil Viscosity	390	Cruising Range	340
Engine Oil Viscosity Chart	390	Engine Oil	340
Enhanced Accident Response Feature	56	Fuel Requirements	337,339
Entry System, Illuminated	21	Replacement Parts	340
Event Data Recorder	58	Starting	340
Exhaust Gas Caution	38,70,337	Flipper Glass, Liftgate	35
Exhaust System	401	Flooded Engine Starting	279
Extender, Seat Belt	48	Fluid Capacities	435
Exterior Finish Care	415	Fluid Leaks	72
Filters		Fluid Level Checks	
Air Cleaner	393	Automatic Transmission	411,412
Engine Oil	391	Engine Oil	389
Engine Oil Disposal	391	Power Steering	398
Finish Care	415	Fluids, Lubricants and Genuine Parts	436
Flashers	366	Fog Light Service	431
Hazard Warning	366	Fog Lights	128,194,431
		Fold and Tumble Rear Seat	113

Folding Rear Seat	113,117	Fuel, Flexible	<i>See Flexible Fuel Vehicles</i>
Four Wheel Drive	290	Fuel System Caution	336,342,343
Operation	290	Fuses	419
Systems	290	Garage Door Opener (HomeLink®)	159
Four Wheel Drive Operation	290	Gas Cap (Fuel Filler Cap)	341,343,386
Four-Way Hazard Flasher	366	Gasoline (Fuel)	333
Freeing A Stuck Vehicle	289	Gasoline, Reformulated	334
Front Axle (Differential)	410	Gasoline/Oxygenate Blends	335
Front Heated Seats	111	Gauges	
Fuel	333	Coolant Temperature	191
Filler Cap (Gas Cap)	341	Fuel	194
Gasoline	333	Speedometer	187
Gauge	194	Tachometer	189
Hoses	407	Gear Ranges	283
Materials Added	336	General Information	20,26,108,333
Octane Rating	333,334	Glass Cleaning	418
Requirements	435	Gross Axle Weight Rating	347
System Hoses	407	Gross Vehicle Weight Rating	346
Tank Capacity	435		

GVWR	344	Hitches	
Hands-Free Phone (UConnect™)	82	Trailer Towing	350
Hard Drive (HDD)	239	Holder, Cup	172
Hazard Warning Flasher	366	HomeLink® (Garage Door Opener) Transmitter	159
Head Restraints	110	Hood Release	123
Head Rests	110	Hoses	406
Headlights	125	Ignition	16
Bulb Replacement	428	Cables (Spark Plug Wires)	392
Cleaning	418	Key	14,16
On With Wipers	126	Wiring System (Spark Plug Wires)	392
Replacing	428	Ignition Key Removal	16
Heated Mirrors	81	Illuminated Entry	21
Heated Seats	111	Immobilizer (Sentry Key)	17
Heater, Engine Block	280	Infant Restraint	60,61
High Beam Indicator	187	Inflation Pressure Tires	316
High Beam/Low Beam Select (Dimmer) Switch	129	Information Center, Vehicle	195
Hill Descent Control	150	Inside Rearview Mirror	78
Hill Start Assist	148	Instrument Cluster	186,187

Instrument Panel and Controls	185	Key-In Reminder	17
Instrument Panel Lens Cleaning	418	Keyless Entry System	21
Integrated Power Module (Fuses)	425	Keys	14
Interior Appearance Care	417	Lap/Shoulder Belts	39
Interior Fuses	419	LATCH (Lower Anchors and Tether for CHildren)	64,65
Interior Lighting	130	Lead Free Gasoline	333
Interior Lights	127,130	Leaks, Fluid	72
Intermittent Wipers (Delay Wipers)	132	Life of Tires	320
Introduction	4	Liftgate	34
Inverter, Power	170	Liftgate Flipper Glass	35
Jack Location	368	Liftgate Window Wiper/Washer	176
Jack Operation	368,371	Lights	72,124
Jacking Instructions	371	Airbag	57,188
Jump Starting	374	Alarm	71
Key, Programming	19	Anti-Lock	188
Key, Replacement	18	Automatic Headlights	126
Key, Sentry (Immobilizer)	17	Back-Up	432

Battery Saver	125	High Beam Indicator	187
Brake Assist Warning	152,193	Illuminated Entry	21
Brake Warning	187	Instrument Cluster	125,127
Bulb Replacement	428	Interior	127,130
Center Mounted Stop	434	Lights On Reminder	128
Courtesy/Reading	130	Low Fuel	195
Cruise	193	Low Tire	190
Daytime Running	128	Malfunction Indicator (Check Engine)	187
Dimmer Switch, Headlight	124,129	Oil Pressure	189
Electronic Stability Program (ESP)		Passing	129
Indicator	152,189,193	Reading	130
Electronic Throttle Control Warning	194	Rear Servicing	432
Fog	128,194,431	Rear Tail	432
Four-Wheel Drive Indicator	193	Seat Belt Reminder	193
Fuses	419	Security Alarm (Theft Alarm)	189
Hazard Warning Flasher	366	Service	428
Headlight Switch	125	Service Engine Soon (Malfunction Indicator)	187
Headlights	428	Side Marker	432
Headlights On With Wipers	126	SmartBeams	126

Tire Pressure Monitoring (TPMS)	190	Maintenance Free Battery	395
Tow/Haul Indicator	192	Maintenance Procedures	389
Traction Control	152,189	Maintenance Schedule	440
Turn Signal	124,129,430,432	Malfunction Indicator Light (Check Engine) . .	187,386
Vanity Mirror	81	Manual, Service	452
Voltage	195	Master Cylinder (Brakes)	408
Load Floor, Cargo	174	Memory Feature (Memory Seat)	118
Loading Vehicle	344	Memory Seat	118
Tires	311	Memory Seats and Radio	118
Locks	28	Mini-Trip Computer	200
Automatic Door	29	Mirrors	78
Child Protection	30	Automatic Dimming	78
Door	28	Electric Powered	80
Power Door	29	Electric Remote	80
Lower Anchors and Tether for CHildren (LATCH)	64,65	Exterior Folding	80
Lubrication, Body	399	Heated	81
Luggage Rack (Roof Rack)	177	Outside	79
Lumbar Support	109	Rearview	78
		Vanity	81

Modifications/Alterations, Vehicle	9	Oil, Engine	389
Monitor, Tire Pressure System	323	Capacity	435
Mopar Parts	388,451	Change Interval	390
MP3 Player	239	Dipstick	389
Multi-Displacement Engine System	306	Disposal	391
Multi-Function Control Lever	124	Filter	391
		Filter Disposal	391
Navigation Radio	242	Identification Logo	390
Navigation System	242	Materials Added to	391
New Vehicle Break-In Period	69	Pressure Warning Light	189
		Recommendation	390,435
Occupant Restraints	38	Synthetic	391
Octane Rating, Gasoline (Fuel)	333,334	Viscosity	390,435
Odometer	192,193	Onboard Diagnostic System	385,386
Trip	192	Opener, Garage Door (HomeLink®)	159
Off-Pavement Driving (Off-Road)	296,414	Outside Rearview Mirrors	79
Off-Road Driving (Off-Pavement)	296,414	Overdrive	286
Oil Change Indicator	200	Overdrive OFF Switch	286
Oil Change Indicator, Reset	200	Overhead Console	158

Overheating, Engine	192,367	USB	239
Owner's Manual (Operator Manual)	452	Power	
Paint Care	415	Distribution Center (Fuses)	422
Paint Damage	415	Door Locks	29
Panic Alarm	24	Inverter	170
Park Sense System, Rear	153	Lift Gate	36
Parking Brake	300	Mirrors	80
Passing Light	129	Outlet (Auxiliary Electrical Outlet)	169
Pedals, Adjustable	135	Seats	110
Personal Settings	205	Steering	305,398
Pets	69	Sunroof	165
Pets, Transporting	69	Windows	31
Phone, Cellular	82	Pregnant Women and Seat Belts	47
Phone, Hands-Free (UConnect™)	82	Preparation for Jacking	370
Placard, Tire and Loading Information	311	Pretensioners	
Polishing and Waxing	415	Seat Belts	46
Port		Programmable Electronic Features	205
Universal Serial Bus (USB)	239	Programming Transmitters (Remote Keyless Entry)	21

Quadra-Trac	290,291	Rear Wiper/Washer	176
Radial Ply Tires	318	Rearview Mirrors	78
Radio Broadcast Signals	210	Reclining Front Seats	108
Radio, Navigation	242	Recorder, Event Data	58
Radio Operation	240,256	Recreational Towing	359
Radio, Satellite	239,240,243,249	Shifting into Transfer Case Neutral (N)	360
Radio (Sound Systems)	239	Shifting out of Transfer Case Neutral (N)	361
Rain Sensitive Wiper System	133	Reformulated Gasoline	334
Rear Air Conditioning	267	Refrigerant	398
Rear Axle (Differential)	410	Reminder, Lights On	128
Rear Camera	157	Reminder, Seat Belt	46
Rear Cup Holder	172	Remote Keyless Entry (RKE)	21
Rear Heater	267	Remote Sound System (Radio) Controls	254
Rear Park Sense System	153	Remote Starting System	26
Rear Seat, Fold and Tumble	113	Replacement Bulbs	427
Rear Seat, Folding	113,117	Replacement Keys	18
Rear Window Defroster	177	Replacement Tires	320
Rear Window Features	176	Reporting Safety Defects	451
		Restraints, Child	60

Restraints, Occupant	38	And Pregnant Women	47
Rocking Vehicle When Stuck	289	Child Restraint	60,67
Roll Over Warning	5	Extender	48
Roof Type Carrier	177	Front Seat	39
Rotation, Tires	322	Inspection	71
		Maintenance	71,419
Safety Checks Inside Vehicle	71	Pretensioners	46
Safety Checks Outside Vehicle	72	Reminder	193
Safety Defects, Reporting	451	Shoulder Belt Anchorage	44
Safety, Exhaust Gas	38	Seats	108
Safety Information, Tire	306	Adjustment	108
Safety Tips	70	Cleaning	417
Satellite Radio	239,240,243,249	Easy Entry	122
Satellite Radio Antenna	250	Fold and Tumble Rear	113
Schedule, Maintenance	440	Head Restraints	110
Seat Belt Maintenance	71	Heated	111
Seat Belt Reminder	46	Lumbar Support	109
Seat Belts	39	Memory	118
Adjustable Upper Shoulder Anchorage	44	Power	110

Rear Folding	113,117	Signals, Turn	129,187,430,432
Reclining	108	Skylights, Command View	168
Seatback Release	117	SmartBeams	126
Security Alarm (Theft Alarm)	20,189	Snow Chains (Tire Chains)	322
Selection of Oil	390	Snow Plow	363
Sentry Key (Immobilizer)	17	Sound Systems (Radio)	239
Sentry Key Programming	19	Spare Tire	369
Sentry Key Replacement	18	Spark Plug Wires (Ignition Cables/Wires)	392
Service Assistance	448	Spark Plugs	392
Service Contract	450	Specifications	
Service Engine Soon Light (Malfunction Indicator)	187	Fuel (Gasoline)	333
Service Manuals	452	Oil	390
Setting the Clock	213,229,240,243	Speed Control (Cruise Control)	136
Settings, Personal	205	Speedometer	187
Shift Lock Manual Override	281	Starting	277
Shifting	281	Automatic Transmission	277
Automatic Transmission	281	Cold Weather	278,280
Shoulder Belts	39	Engine Block Heater	280
		Engine Fails to Start	279

Remote	26	Telescoping Steering Column	134
Steering		Temperature Control, Automatic (ATC)	260
Power	305,398	Temperature Gauge, Engine Coolant	191
Tilt Column	134	Tether Anchor, Child Restraint	64
Wheel, Tilt	134	Tilt Steering Column	134
Steering Wheel Mounted Sound System		Time Delay, Headlight	129
Controls	254	Tire and Loading Information Placard	311
Storage	426	Tire Identification Number (TIN)	310
Storage, Vehicle	270,426	Tire Markings	306
Storing Your Vehicle	426	Tire Safety Information	306
Sun Roof	165	Tires	72,315,454
Sun Visor Extension	81	Air Pressure	316
Supplemental Restraint System - Airbag	48	Alignment and Balance	321
Sway Control, Trailer	147	Chains	322
Synthetic Engine Oil	391	Changing	368
System, Navigation	242	General Information	315
System, Remote Starting	26	High Speed	318
Tachometer	189	Inflation Pressures	316
		Jacking	368

Life of Tires	320	Disabled Vehicle	378
Load Capacity	311,312	Guide	350
Pressure Monitor System (TPMS)	323	Recreational	359
Pressure Warning Light	190	Weight	350
Quality Grading	454	Traction Control	140
Radial	318	Traction Control Light	189
Replacement	320	Trailer Sway Control (TSC)	147
Rotation	322	Trailer Towing	346
Safety	72,306	Cooling System Tips	358
Sizes	308	Hitches	350
Spare Tire	369	Minimum Requirements	353
Spinning	318	Trailer and Tongue Weight	352
Tread Wear Indicators	319	Wiring	356
Wheel Mounting	373	Trailer Towing Guide	350
Tongue Weight/Trailer Weight	352	Trailer Weight	350
Torque Converter Clutch	288	Transfer Case	410
Tow Hooks, Emergency	377	Maintenance	410
Tow/Haul Indicator Light	192	Transmission	
Towing	346,378	Automatic	283,411

Maintenance	411	Upholstery Care	417
Range Indicator	194	USB Port	239
Shifting	281		
Transmitter Battery Service (Remote Keyless Entry)	25	Vacuum/Vapor Harnesses	406
Transmitter, Garage Door Opener (HomeLink®) . .	159	Vanity Mirrors	81
Transmitter Programming (Remote Keyless Entry)	21	Variance, Compass	204
Transmitter, Remote Keyless Entry (RKE)	21	Vehicle Identification Number (VIN)	8
Tread Wear Indicators	319	Vehicle Loading	312,344
Turn Signals	129,187,430,432	Vehicle Modifications/Alterations	9
		Vehicle Storage	270,426
UCI Connector	244	Video Entertainment System (Rear Seat Video System)	253
UConnect™ (Hands-Free Phone)	82	Viscosity, Engine Oil	390
Underhood Fuses	422,425		
Uniform Tire Quality Grades	454	Warning Flasher, Hazard	366
Universal Consumer Interface (UCI) Connector . .	244	Warning, Roll Over	5
Universal Serial Bus (USB) Port	239	Warnings and Cautions	8
Universal Transmitter	159	Warranty Information	451
		Washer, Adding Fluid	177

Washers, Windshield	131,400	Power	31
Washing Vehicle	415	Windshield Defroster	71,258,265
Waxing and Polishing	415	Windshield Washers	131
Wheel Alignment and Balance	321	Fluid	400
Wheel and Wheel Trim	417	Windshield Wiper Blades	400
Wheel and Wheel Trim Care	417	Windshield Wipers	131
Wheel Mounting	373	Wipers, Intermittent	132
Wind Buffeting	33,167	Wipers, Rain Sensitive	133
Window Fogging	269	Wiring, Ignition (Spark Plug Wires)	392
Windows	31		

